



OMNI-IP

Scalable IP Solutions



KNC-p3DR3IR

KNC-p3DR4IR

KNC-p3DR6IR

KNC-p3DR12IR

3 Megapixel Plug & Play Capable 3-Axis
IP66 IR Mini IP Dome Cameras with SD

Quick Operation Guide

Thank you for selecting this KT&C Omni IP Series product. For additional information please refer to the complete User Guide for this cameras series. End users should contact their KT&C Certified Dealer for service. Certified Dealers can obtain support directly from KT&C.

About This Guide

While KT&C makes every effort to insure the completeness and accuracy of the information contained in this Guide, we are not responsible for typographical errors or misprints. At the same time, KT&C reserves the right to make changes to improve the performance of our products at any time without notice, and so the specifications and content of this document are subject to change without notice. Every effort will be made to include updates in new versions of this manual and/or online.

DISCLAIMER STATEMENT

“Underwriters Laboratories Inc. (“UL”) has not tested the performance or reliability of the security or signaling aspects of this product. UL has only tested for fire, shock or casualty hazards as outlined in UL’s Standard(s) for Safety, UL60950-1. UL Certification does not cover the performance or reliability of the security or signaling aspects of this product. UL MAKES NO REPRESENTATIONS, WARRANTIES OR CERTIFICATIONS WHATSOEVER REGARDING THE PERFORMANCE OR RELIABILITY OF ANY SECURITY OR SIGNALING RELATED FUNCTIONS OF THIS PRODUCT.

Regulatory Information

FCC Information

FCC compliance: This equipment has been tested and found to comply with the limits for a digital device, pursuant to part 15 of the FCC Rules. These limits are designed to provide reasonable protection against harmful interference when the equipment is operated in a commercial environment. This equipment generates, uses, and can radiate radio frequency energy and, if not installed and used in accordance with the instruction manual, may cause harmful interference to radio communications. Operation of this equipment in a residential area is likely to cause harmful interference in which case the user will be required to correct the interference at his own expense.

FCC Conditions

This device complies with part 15 of the FCC Rules. Operation is subject to the following two conditions:

1. This device may not cause harmful interference.
2. This device must accept any interference received, including interference that may cause undesired operation.

EU Conformity Statement



This product and - if applicable - the supplied accessories too are marked with "CE" and comply therefore with the applicable harmonized European standards listed under the Low Voltage Directive 2006/95/EC, the EMC Directive 2004/108/EC, the RoHS Directive 2011/65/EU.



2012/19/EU (WEEE directive): Products marked with this symbol cannot be disposed of as unsorted municipal waste in the European Union. For proper recycling, return this product to your local supplier upon the purchase of equivalent new equipment, or dispose of it at designated collection points. For more information see: www.recyclethis.info.



2006/66/EC (battery directive): This product contains a battery that cannot be disposed of as unsorted municipal waste in the European Union. See the product documentation for specific battery information. The battery is marked with this symbol, which may include lettering to indicate cadmium (Cd), lead (Pb), or mercury (Hg). For proper recycling, return the battery to your supplier or to a designated collection point. For more information see: www.recyclethis.info



Safety Instructions

These instructions are intended to ensure that the camera is installed in a manner that avoids danger to persons or property loss.

These precautionary measures are divided into “Warnings” and “Cautions”

Warnings: Serious injury or death may occur if any of the warnings are neglected.

Cautions: Injury or equipment/property damage may occur if any of the cautions are neglected.

	
<p>Warnings Follow these safeguards to prevent serious injury or death.</p>	<p>Cautions Follow these precautions to prevent potential injury or material damage.</p>



Warnings

- In the use of the product, you must be in strict compliance with the electrical safety regulations of the nation and region. Please refer to technical specifications for detailed information.
- Input voltage should meet the requirements for both the SELV (Safety Extra Low Voltage) and Limited Power Source for 12 VDC

according to the IEC60950-1 standard; or 802.3af PoE. Please refer to technical specifications for detailed information.

- If connecting several devices to one power supply, to avoid any overload that may cause over-heating or a fire hazard insure that the power supply is adequate for the power load.
- Please make sure that all plugs are firmly connected to the power sockets. When the product is mounted on wall or ceiling, the device shall be firmly attached, taking into consideration any wind, snow loading, or other factors. The mounting surface shall be capable of supporting several times the base weight of the camera.
- If smoke, unusual odors or noise come from the device, turn off the power at once and unplug the power cable, and then contact authorized service personnel.



Cautions

- Make sure the power supply voltage is correct before using the camera.
- Do not drop the camera or subject it to physical shock.
- Do not touch lenses or sensor modules with fingers. If cleaning is necessary, use clean cloth with a bit of ethanol and wipe gently. If the camera will not be used for an extended period, please protect the lens openings from damage and/or debris.
- Avoid aiming the camera at the sun or extremely bright light sources. Blooming or smearing may occur in excessive light

(which is not a malfunction), and could compromise the performance of the sensor.

- The sensor may be damaged if exposed to laser energy, so when any laser equipment is in use, make sure that the sensor will not be exposed to the laser beam.
- Do not place the camera in extremely hot or cold (see camera specifications) locations. Do not exceed the rated environmental (IP66) conditions. Do not expose the camera to high levels of electromagnetic (RF) radiation.
- To avoid heat accumulation, good ventilation is required in the operating environment.
- Keep the camera away from solvents while in use; exposure to liquids should not exceed IP66 environmental conditions.
- During shipping, the camera shall be packed in its original packing, or packing providing the equivalent protection.
- Improper use or replacement of any batteries (if so equipped) may result in the hazard of explosion. Replace with the same or equivalent type only. Dispose of used batteries according to the instructions provided by the battery manufacturer.
- If the product does not function properly, Dealers please contact KT&C; End Users please contact your KT&C Certified Dealer or an authorized service center. Do not disassemble the camera for repair or maintenance by yourself. (KT&C shall not assume any responsibility for problems caused by unauthorized repair or maintenance.)

Table of Contents

1 Appearance and Description	8
2 Installation	10
2.1 Mounting	11
2.2 Micro SD Card Installation	16
3 Setting the Camera Parameters over the LAN	18

1 Appearance and Description

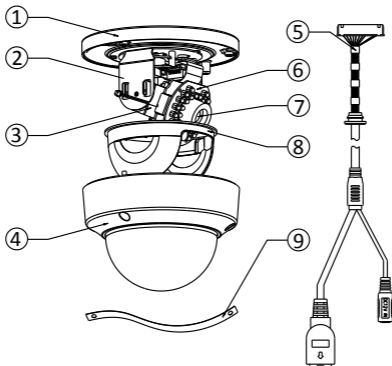

Figure 1-1 Overview

Table 1-1 Description

No.	Description
1	Camera Base
2	Rotation Mechanism
3	Pan/Tilt Mechanism

No.	Description
4	Cover and Dome Bubble
5	Power/Network Cables
6	IR LEDs
7	Lens
8	Dome Liner (conceals direction)
9	Safety Cord

NOTE Press RESET about 10s when the camera is powering on or rebooting to restore the default settings, including the user name, password, IP address, port No., etc.

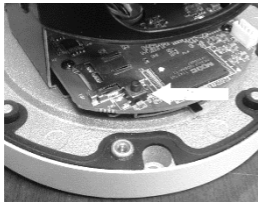

2 Installation

Before you start:

- This is a 3-axis camera, so mounting to the ceiling or wall is suitable.
- Make sure the camera is in good condition and all the accessory parts are included.
- Make sure all related equipment is powered-off during the installation.
- Check to insure that the specifications of the camera are correct for the installation environment.
- Make sure the power supply voltage is 12VDC or PoE compliant to avoid damage to the camera.
- If the product does not function properly, Dealers please contact KT&C; End Users please contact your KT&C Certified Dealer or an authorized service center. Do not disassemble the camera for repair or maintenance by yourself.
- Make sure that the mounting surface is strong enough to withstand three times the weight of the camera.



If the IR LEDs in this camera will be active, you must observe the following precautions to prevent IR reflection:

- Dust or grease on the lens/dome cover will cause IR reflection. Please do not remove the cover protective film until the

installation is finished. If there is dust or grease on the lens/dome cover, clean the lens/dome cover with clean soft cloth and isopropyl alcohol.

- Make sure that there is no reflective surface too close to the camera lens. The IR light from the camera may reflect back into the lens causing haze, distortion or improper scene exposure.
- The foam ring around the lens must be seated flush against the inner surface of the cover/bubble to isolate the lens from the IR LEDs. Fasten the lens/dome cover to camera body so that the foam ring and the dome cover are attached seamlessly.

2.1 Mounting

Steps:

1. Drill the screw holes into the ceiling according to the drill template.

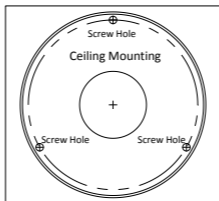

Figure 2-1 Drilling Template

- Loosen the cover screws with a hex key (supplied) to remove the cover and dome bubble.

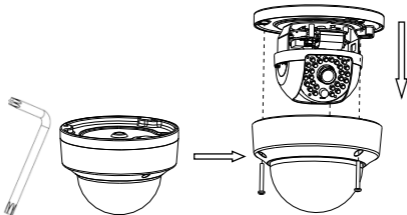

Figure 2-2 Remove the Bubble

- Attach the mounting base on the wall or ceiling with screws and anchors if required.

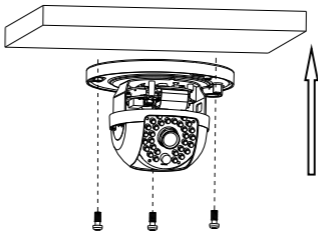

Figure 2-3 Attach the Mounting Base



If surface mounting, you can route the cable through the side opening in the mounting base.

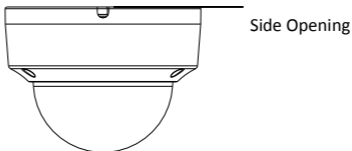

Figure 2-4 Side Opening

4. Loosen the tilt lock screws, adjust the tilt position in a range of 75 degrees, and tighten the tilt lock screws. Figure 2-5
5. Rotate the pan mechanism to adjust the pan and camera body rotation positions in a range of 0~355 degrees until you align in the desired direction and the image is upright. Remove the black liner to adjust the camera module rotation. Figure 2-6

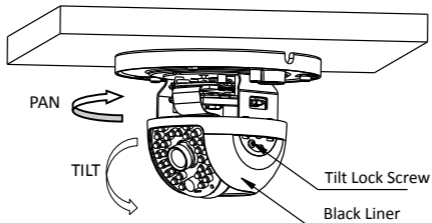

Figure 2-5 Pan/Tilt Angle Adjustment – Liner Removed

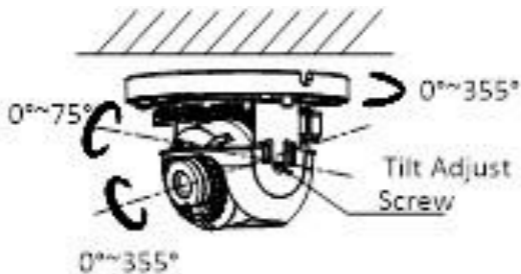

Figure 2-6 3-Axis Angle Adjustment – Liner Removed



As the lens has already been factory adjusted to the best imaging effect, you just need to adjust the pan position and tilt position to get the desired field of view.

6. Reinstall the liner if it has been removed, reinstall the cover/bubble and tighten the screws.

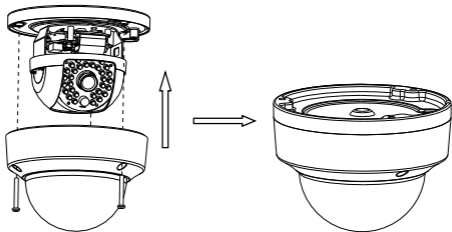

Figure 2-7 Bubble Reinstallation

2.2 Micro SD Card Installation

Steps:

1. Loosen the lock screws on the bubble to disassemble the camera.

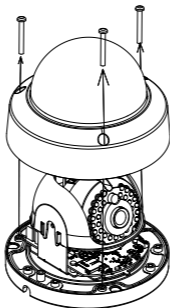

Figure 2-8 Disassemble the Camera

2. Insert the micro SD card to the card slot.
3. (Optional) Push the inserted micro SD card inside, and the micro SD card will be sprung out.

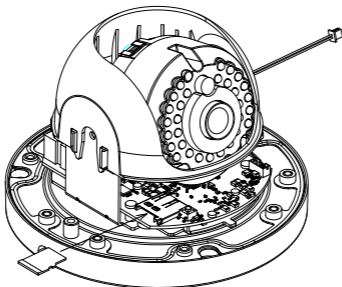

Figure 2-9 Insert the Micro SD Card

4. Install the bubble back, and tighten the lock screws on it.

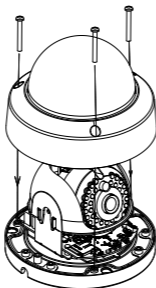

Figure 2-10 Install the Bubble

3 Setting the Camera Parameters over the LAN

Purpose:

To view and configure the camera via a LAN, you need to connect the network camera in the same subnet with your computer, and install the OMNI Finder or OMNI CMS software to search and change the IP of the network camera.

The following figure shows a camera and PC connected through a switch:

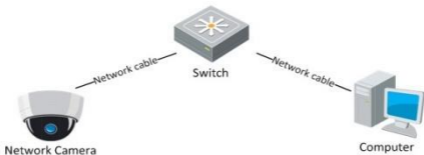

Figure 3-1 Typical LAN Connection

Set the IP address of the camera for accessing via LAN.

Steps:

1. To get the IP address, you can choose either of the following methods:
 - Use OMNI Finder, a software tool which can automatically detect network camera on the LAN and list device information such as IP address, subnet mask, port number, device serial number, device version, etc., as shown in Figure 3.2 below.

- Use OMNI CMS software and to list the online devices. Please refer to the user manual for the OMNI CMS software for detailed information.
- 2. Change the IP address and subnet mask to the same subnet as that of your computer, or change your computer to match the address/subnet of the camera.

Refer to the following introductions to set IP address with OMNI Finder software:

- Search active devices online**

Search online devices automatically:

After launching the OMNI Finder software, it automatically searches for online devices every 15 seconds on the subnet where your computer is connected. It displays the total number and information of the discovered devices in the Online Devices interface. Device information including the device type, IP address, port number, gateway, etc. will be displayed.

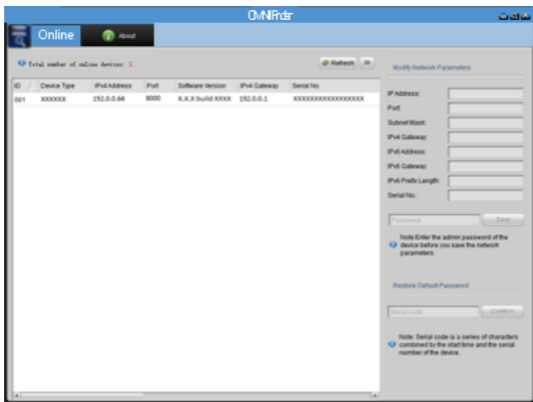



Figure 3-2 Search Online Devices







Devices can be discovered and displayed in the list in 15 seconds after they go online; devices will be removed from the list in 45 seconds after going offline.

Search online devices manually:

You can also click  to refresh the online device list manually. The newly searched devices will be added to the list.



You can click  or  on each column heading to order the information; you can click  to show the device table and hide the network parameter panel on the right side, or click  to show the network parameter panel.

1.2 Modify device information

Steps:

- 1) Select the device to be modified in the device list as shown in Figure 3-3. The network parameters of the device will be displayed in the Modify Network Parameters panel on the right side as shown in Figure 3-4.
- 2) Edit the modifiable network parameters, e.g. IP address, subnet, port number and gateway. **NOTE:** This port is the CONTROL port used by the Finer and CMS. It is NOT the HTTP web browsing port (which defaults to 80).
- 3) Enter the password of the admin account of the device in the Password field and click **Save** to save the changes.

ID	Device Type	IPv4 Address	Port	Software Version	IPv4 Gateway	Serial No.
001	XXXXXX	192.0.0.64	8000	X.X.X build XXXX	192.0.0.1	XXXXXXXXXXXXXXXXXXXX

Figure 3-3 Select a Device

Modify Network Parameters

IP Address:

Port:

Subnet Mask:

IPv4 Gateway:

IPv6 Address:

IPv6 Gateway:

IPv6 Prefix Length:

Serial No.:

Note: Enter the admin password of the device before you save the network parameters.

Figure 3-4 Modify Network Parameters

- 4) Enter the IP address of network camera in the address field of the web browser to view the live video.



The default value of the IP address is “192.0.0.64”. The default user name is “admin”, and password is “12345”.

For accessing the network camera from different subnets, please set the gateway for the network camera after you log in.

4 Accessing via Web Browser

System Requirement:

Operating System: Microsoft Windows XP SP1 and above version / Vista / Win7 / Server 2003 / Server 2008 32bits

CPU: Intel Pentium IV 3.0 GHz or higher

RAM: 1G or higher

Display: 1024×768 resolution or higher

Web Browser: Internet Explorer 6.0 and above version, Apple Safari 5.02 and above version, Mozilla Firefox 3.5 and above version and Google Chrome8 and above version

Steps:

1. Open the web browser.
2. In the browser address bar, input the IP address of the network camera, e.g., 192.0.0.64 and press the **Enter** key to enter the login interface.
3. Input the user name and password.

- Click **Login**.

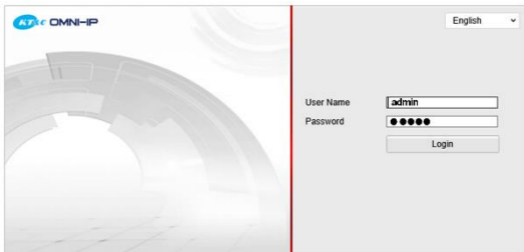

Figure 4-1 Login Interface

- Install the plug-in before viewing the live video and managing the camera. Please follow the installation prompts to install the plug-in.



It is recommended to close the web browser before finishing the installation of the plug-in.

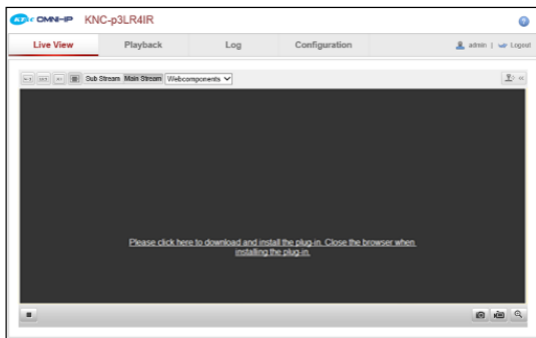

Figure 4-2 Download Plug-in

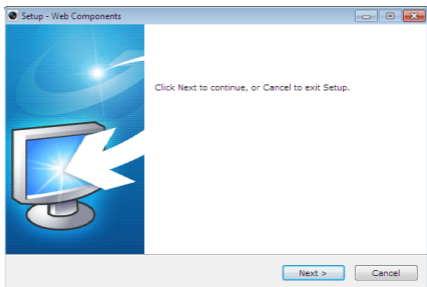

Figure 4-3 Install Plug-in (1)

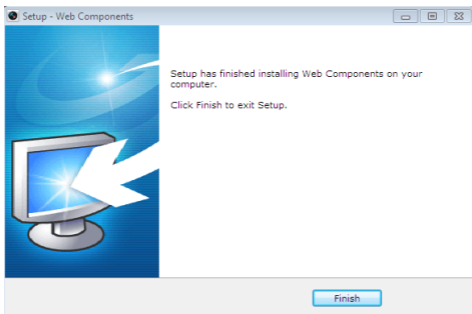

Figure 4-4 Install Plug-in (2)

6. Reopen the web browser after the installation of the plug-in and repeat steps 2-4 to login.



For more detailed instructions about further configuration, please refer to the user manual for this series of network cameras.

KT&C America
www.ktncusa.com

New Jersey Office
40 Lane Road 1st Floor
Fairfield, NJ 07004
T: 973 276 0118
F: 973 276 0 116

New York Office
200 Plwy Drive South Suite 200
Hauppauge, NY 11788
T: 631 864 0118
F: 631 864 0116

California Office
3240 White Blvd Suite 501
Los Angeles, CA 90010
T: 213 381 0061
F: 213 381 0064