

GV-MFD2501 2MP H.264 Super Low Lux WDR Mini Fixed Dome



- 1/2.8" progressive scan super low lux CMOS
 - Min. illumination at 0.02 lux
 - Dual streams from H.264 and MJPEG
 - Up to 30 fps at 1920 x 1080
 - Day and night function (electronic)
 - USB slot for [GV-WiFi Adapter](#) or USB hard drive
 - Built-in micro SD card slot (SD/SDHC) for local storage
 - Recording assigned by GV-Edge Recording Manager ([Windows](#), [Mac](#) version)
 - Active Tampering alarm
 - Wide Dynamic Range (WDR)
 - 3D noise reduction
 - Two-way audio
 - Defog
 - Motion detection
 - Privacy mask
 - IP address filtering
 - iPhone, iPad, Android
 - DC 5V / PoE (IEEE 802.3af)
 - Megapixel lens
 - Supports iPhone, iPad, Android & 3GPP
 - 31 languages on Web interface
 - ONVIF (Profile S) conformant
 - More Storage Option - [NAS](#)
- * No Memory card slot & local storage function for Argentina.

Introduction

The GV-MFD2501 Series is an indoor, fixed, mini-sized network camera with different lens options. With its super low lux CMOS image sensor, the camera can produce color image at near darkness. The camera is equipped with a USB port which supports wireless connection through GV-WiFi Adapter (optional) or an external storage using a USB hard drive.

Active Tampering Alarm

Tampered



Focus Change



Camera Shift

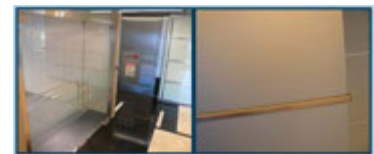

Models

Models	Iris	Focal Length (mm)	Maximum Aperture	Image Format
MFD2501-0F	Fixed	2.8 mm	F/2.0	1/3"
MFD2501-1F		4 mm	F/1.5	
MFD2501-2F		8 mm	F/1.6	
MFD2501-3F		12 mm	F/1.6	
MFD2501-5F		3.8 mm	F/1.8	
MFD2501-6F		2.3 mm	F/2.2	

Dimensions

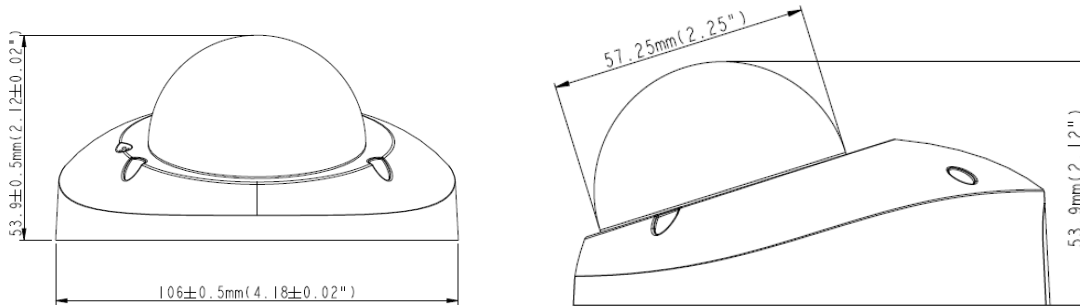

Specifications

Camera		GV-MFD2501 -0F	GV-MFD2501 -1F	GV-MFD2501 -2F	GV-MFD2501 -3F	GV-MFD2501 -5F	GV-MFD2501 -6F
Image Sensor		1/2.8" progressive scan super low lux CMOS					
Picture Elements		1920 (H) x 1080 (V)					
Minimum Illumination	Color B/W	0.02 Lux					
Shutter Speed		Automatic, Manual (1/5 ~ 1/8000 sec.)					
White Balance		Automatic, Manual (2800K ~ 8500K)					
Gain Control		Automatic					
S/N Ratio		52 dB					
WDR		Yes					
Lens							
Megapixel		Yes					
Day/Night		Yes (Electronic)					
Iris		Fixed					
Focal Length		2.8 mm	4 mm	8 mm	12 mm	3.8 mm	2.3 mm
Maximum Aperture		F/2.0	F/1.5	F/1.6	F/1.6	F/1.8	F/2.2
Mount		M12, Pitch 0.5 mm					
Image Format		1/3"					
Horizontal FOV		99°	72°	38°	25°	72°	122°
Operation	Focus	Fixed					
	Zoom	Fixed					
	Iris	Fixed					
Operation							
Video Compression		H.264, MJPEG					
Video Streaming		Dual streams from H.264 and MJPEG					
Frame Rate		30 fps at 1920 x 1080 (60/50 Hz) * The frame rate and the performance may vary depending on the number of connections and data bitrates (different scenes).					
Image Setting		Brightness, Contrast, Saturation, Sharpness, Gamma, White Balance, Flicker-less 50/60 Hz, Image Orientation, Shutter Speed, Backlight Compensation, D/N Sensitivity, WDR, Defog, Super Low Lux, Denoise, Metering					
Audio Compression		G.711, AAC (optional)					
Audio Support		Two-Way Audio					
Sensor Input		No					
Alarm Output		No					
Video Resolution							
Main Stream	4:3	1280 x 960, 640 x 480, 320 x 240					
	16:9	1920 x 1080 (Default), 1280 x 720, 640 x 360, 448 x 252					
	5:4	1280 x 1024, 640 x 512, 320 x 256					
Sub Stream	4:3	640 x 480, 320 x 240					
	16:9	640 x 360, 448 x 252 (Default)					
	5:4	640 x 512, 320 x 256					

Network		
Interface	10/100 Ethernet	
Ethernet Protocol	DHCP, DynDNS, FTP, HTTP, HTTPS, NTP, ONVIF (Profile S), PSIA, QoS (DSCP), RTSP, SNMP, SMTP, TCP, UDP, UPnP, 3GPP/ISMA	
Mechanical		
Temperature Detector	Yes	
Camera Angle Adjustment	Pan	-45° ~ 45°
	Tilt	0° ~ 90°
Connectors	Power	2-pin terminal block, PoE
	Ethernet	Ethernet (10/100 Base-T), RJ-45
	Audio	1 In (built-in microphone), 1 Out (RCA female for speaker)
	USB	GV-WiFi Adapter or USB hard drive
	Local Storage	Micro SD card slot (SD/SDHC, SD version 2.0 only, Class 10) * SDXC and UHS-I card types are not supported.
LED Indicator	4 LEDs: Link, ACT, Power, Status	
General		
Camera Housing	black, white	
Environment Temperature	0 °C ~ 50 °C (32 °F ~ 122 °F)	
Humidity	10% to 90% (no condensation)	
Power Source	5V DC/PoE (IEEE 802.3af)	
Max. Power Consumption	6 W	
Dimension	ø 106 x 53.9 mm (4.2" x 2.1")	
Weight	280 g (0.62 lb)	
Regulatory	CE, FCC, RCM, RoHS compliant	
Power over Ethernet		
PoE Standard	PoE (IEEE 802.3af Power over Ethernet / PD)	
PoE Power Supply Type	End-Span	
PoE Power Output	Per Port 48V DC, 350mA. Max. 15.4 watts	
Web Interface		
Installation Management	Web-based configuration	
Maintenance	Firmware upgrade through Web Browser or Utility	
Access from Web Browser	Camera Live View, Video Recording, Change Video Quality, Bandwidth Control, Image Snapshot, Audio, Picture in Picture, Picture and Picture, Privacy Mask, Text Overlay, Digital PTZ	
Language	Arabic / Bulgarian / Czech / Danish / Dutch / English / Finnish / French / German / Greek / Hebrew / Hungarian / Indonesian / Italian / Japanese / Lithuanian / Norwegian / Persian / Polish / Portuguese / Romanian / Russian / Serbian / Simplified Chinese / Slovakian / Slovenian / Spanish / Swedish / Thai / Traditional Chinese / Turkish	
Applications		
Network Storage	GV-System (GV-DVR/NVR), GV-Backup Center, GV-Recording Server, GV-VMS	
Smart Device Access	GV-Eye for iOS and Android	
Live Viewing	IE, Mobile App	
CMS Server support	GV-Control Center, GV-Center V2, GV-Vital Sign Monitor	

Note:

- Mind the following limitations and requirements for the USB port:
 - The USB hard drive must be of 2.5" or 3.5", version 2.0 or above
 - The USB hard drive's storage capacity must not exceed 2TB
 - USB flash drives and USB hubs are not supported
 - External power supply is required for the USB hard drive
 - To connect the GV-WiFi Adapter, make sure it is connected before the camera is powered on.
- Mind the following when using an inserted memory card for recording:
 - Recorded data on the memory card can be damaged or lost if the data are accessed while the camera is under physical shock, power interruption, memory card detachment or when the memory card reaches the end of its lifespan. No guarantee is provided for such causes.
 - The stored data can be lost if the memory card is not accessed for a long period of time. Back up your data periodically if you seldom access the memory card.





- Memory cards are expendable and their durability varies according to the conditions of the installed site and how they are used. Back up your data regularly and replace the memory card annually.
 - To avoid power outage, it is highly suggested to apply a battery backup (UPS).
 - For better performance, it is highly suggested to use Micro SD card of MLC NAND flash, Class 10.
 - Replace the memory card when its read/write speed is lower than 6 MB/s or when the memory card is frequently undetected by the camera.
3. Specifications are subject to change without notice.



Packing List

- | | |
|---------------------------|--------------------------------|
| 1. Mini Fixed Dome | 7. USB / Audio Y-cable |
| 2. Torx Wrench | 8. Power Adapter |
| 3. Self Tapping Screw x 2 | 9. GV-IPCAM H.264 Software DVD |
| 4. Screw Anchor x 2 | 10. GV-NVR Software DVD |
| 5. Cable Stopper | 11. Warranty Card |
| 6. Short-Body RJ-45 Plug | |

Note: The power adapter can be excluded upon request.

Accessories

Model No./Name	Details
GV-Mount900 Wall Mount Bracket 	Dimensions: 154 x 108 x 50 mm (6.1 x 4.3 x 2") Weight: 240 g (0.53 lb)
GV-Mount909 Wall Box Mount 	Dimensions: 170 x 150 x 110 mm (6.7 x 5.9 x 4.3") Weight: 0.61 kg (1.34 lb)
GV-Mount910 Power Box Mount Bracket 	Dimensions: 112 x 98 x 7.5 mm (4.4 x 3.9 x 0.3") Weight: 105 g (0.23 lb)
GV-Mount913 Power Box Mount Bracket 	Dimensions: \varnothing 146 x 7.5 mm (\varnothing 5.7 x 0.3") Weight: 180 g (0.4 lb)

Model No./Name	Details
<p>GV-Mount918 Wall Mount Bracket for MFD/MDR/EFD/EDR</p> 	<p>Dimensions: Ø 145 x 117 x 96 mm (Ø 5.71 x 4.60 x 3.78") Weight: 350 g (0.77 lb)</p>
<p>GV-PA191 PoE Adapter</p> 	<p>Dimensions (H x W x D): 43 x 69 x 40 mm (1.69" x 2.72" x 1.57") Weight: 130 g (0.29 lb)</p>
<p>Power Adapter</p>	<p>Contact your sales representative for the countries and areas supported.</p>
<p>GV-POE Switch</p>	<p>The GV-POE Switch is designed to provide power along with network connection for IP devices. The GV-POE Switch is available in various models with different numbers and types of ports.</p>