

## GV-BL3411 3MP H.264 3x zoom WDR Pro IR Bullet IP Camera



- 3 megapixel progressive scan CMOS
- Dual streams from H.264 and MJPEG
- Up to 20 fps at 2048 x 1536
- Intelligent IR
- IR distance up to 50 m (164 ft)
- P-Iris for auto iris adjustment
- Motorized varifocal lens for remote focus/zoom adjustment
- Vandal resistance (IK10 for metal casing)
- Ingress protection (IP67)
- Tolerant to extreme temperatures (-20°C ~ 50°C/-4°F ~ 122°F)
- One alarm input and sensor output
- Built-in micro SD card slot (SD/SDHC) for local storage
- Recording assigned by GV-Edge Recording Manager (Windows, Mac version)
- 2-way audio
- Wide Dynamic Range Pro (WDR Pro)
- 2D noise reduction
- Defog
- Motion detection
- Tampering alarm
- Privacy mask
- IP address filtering
- DC 12V / AC 24V / PoE (IEEE 802.3af)
- Removable IR-cut filter for Day/Night function
- Supports iPhone, iPad, Android & 3GPP
- 31 languages on Web interface
- ONVIF (Profile S) conformant
- More storage option – NAS

\* No Memory Card Slot & local storage function for Argentina.

### Introduction

GV-BL3411 is an outdoor Bullet Camera that can produce clear image for scenes containing contrasting intensity of lights using its WDR Pro sensor. With the motorized focus/zoom, users can remotely adjust the focus and zoom from the Web interface. The camera is also equipped with a P-Iris, which allows for precise control of exposure, producing images with better clarity and contrast.

### Active Tampering Alarm

Tampered



Focus Change



Camera Shift

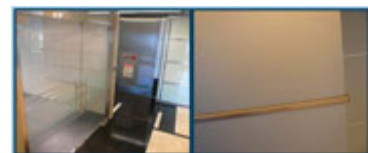

## Dimensions

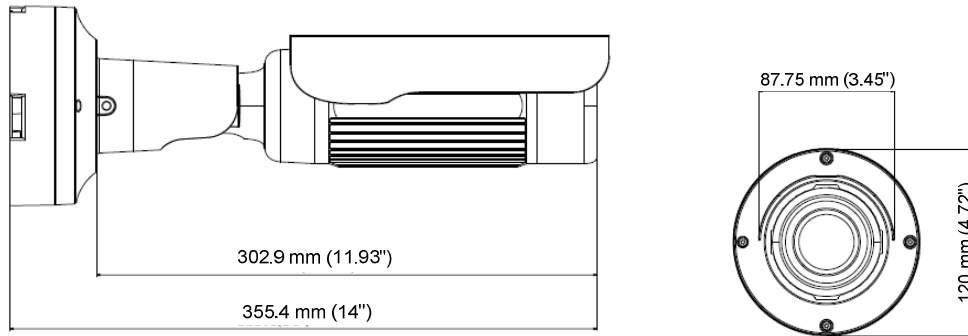

## Specifications

Camera		
Image Sensor	1/3.2" progressive scan CMOS "	
Picture Elements	2048 (H) x 1536 (V)	
Minimum Illumination	Color	0.08 Lux
	B/W	0.05 Lux
	IR ON	0 Lux
Shutter Speed	Automatic, manual (1/5 ~ 1/8000 sec.)	
White Balance	Automatic, manual (2800K ~ 8500K)	
Gain Control	Automatic	
S/N Ratio	47 dB	
BLC	Yes	
WDR Pro	Yes (with WDR sensor)	
Dynamic Range	Up to 100 dB	
Lens		
Megapixel	Yes	
Focal Length	3 ~ 9 mm	
Day/Night	Yes (with removable IR-cut filter)	
Lens Type	Motorized varifocal lens	
Maximum Aperture	F/1.2	
Mount	Ø 14 mm	
Image Format	1/2.7"	
Horizontal FOV	86° ~ 31°	
Operation	Focus	Auto focus
	Zoom	3X optical zoom
	Iris	P-Iris
IR LED Quantity	16 IR LEDs	
Max. IR Distance	50 m (164 ft)	
Operation		
Video Compression	H.264, MJPEG	
Video Stream	Dual streams from H.264 or MJPEG	
Frame Rate	20 fps at 2048 x 1536 (60/50 Hz) *The frame rate and the performance may vary depending on the number of connections and data bitrates (different scenes).	
Image Setting	Brightness, Contrast, Saturation, Sharpness, Gamma, White Balance, Flicker-less, Image Orientation, Shutter Speed, D/N Sensitivity, Backlight Compensation, WDR, Defog, Zoom, Focus Change, Denoise, Metering	
Audio Compression	G.711, AAC (optional)	
Audio Support	Two-way audio	
Sensor Input	1 Input (dry contact)	
Alarm Output	1 Digital output (200 mA 5V DC)	
Video Resolution		
Main Stream	4 : 3	2048 x 1536 (Default), 1600 x 1200, 1280 x 960, 640 x 480, 320 x 240
	16 : 9	1920 x 1080, 1280 x 720, 640 x 360, 448 x 252
	5 : 4	1280 x 1024, 640 x 512, 320 x 256
Sub Stream	4 : 3	640 x 480, 320 x 240 (Default)
	16 : 9	640 x 360, 448 x 252

	5 : 4	640 x 512, 320 x 256
<b>Network</b>		
Interface	10/100 Ethernet	
Protocol	HTTP, HTTPS, TCP, UDP, SMTP, FTP, DHCP, NTP, UPnP, DynDNS, 3GPP/ISMA, RTSP, PSIA, SNMP, QoS (DSCP), ONVIF (Profile S)	
<b>Mechanical</b>		
Temperature Detector	Yes	
Camera Angle Adjustment	Pan	0° ~ 360°
	Tilt	90° ~ 180°
	Rotate	0° ~ 360°
<b>Mechanical</b>		
Connectors	Power	2-pin terminal block, PoE
	Ethernet	Ethernet (10/100 Base-T), RJ-45 Cable
	Audio	1 In (3.5 mm / 0.14" phone jack for microphone) 1 Out (3.5 mm / 0.14" Stereo phone jack for speaker)
	Digital I/O	3-pin terminal block, pitch 2.5 mm / 0.1"
	Local Storage	Micro SD card slot (SD/SDHC, SD version 2.0 only, Class 10) *SDXC and UHS-I card types are not supported.
<b>General</b>		
Environment Temperature	-20°C ~ 50°C (-4 °F ~ 122 °F)	
Humidity	10% to 90% (no condensation)	
Power Source	12V DC / 24V AC / PoE (IEEE 802.3af)	
Max. Power Consumption	12.48 W	
Dimensions	355.4 x 87.75 x 120 mm (14" x 3.45" x 4.72")	
Weight	1.96 kg (4.32 lb)	
Ingress Protection	IP67	
Vandal Resistance	IK10 for metal casing	
Regulatory	CE, FCC, RCM, RoHS compliant	
<b>Power over Ethernet</b>		
PoE Standard	PoE (IEEE 802.3af Power over Ethernet / PD)	
PoE Power Supply Type	End-span	
PoE Power Output	Per Port 48V DC, 350 mA, Max. 15.4 watts	
<b>Web Interface</b>		
Installation Management	Web-based configuration	
Maintenance	Firmware upgrade through Web Browser or Utility	
Access from Web Browser	Camera Live View, Video Recording, Change Video Quality, Bandwidth Control, Image Snapshot, Digital I/O Control, Audio, Picture in Picture, Picture and Picture, Privacy Mask, Visual Automation, Tampering Alarm, Text Overlay, Digital PTZ	
Language	Arabic / Bulgarian / Czech / Danish / Dutch / English / Finnish / French / German / Greek / Hebrew / Hungarian / Indonesian / Italian / Japanese / Lithuanian / Norwegian / Persian / Polish / Portuguese / Romanian / Russian / Serbian / Simplified Chinese / Slovakian / Slovenian / Spanish / Swedish / Thai / Traditional Chinese / Turkish	
<b>Application</b>		
Network Storage	GV-System (GV-DVR/NVR), GV-Backup Center, GV-Recording Server, GV-VMS	
Smart Device Access	GV-Eye for iOS and Android	
Live Viewing	IE, mobile phone	
CMS Server support	GV-Control Center, GV-Center V2, GV-Vital Sign Monitor	

**Note:**







- Specifications are subject to change without prior notice.
- Mind the following when using an inserted memory card for recording:
  - Recorded data on the memory card can be damaged or lost if the data are accessed while the camera is under physical shock, power interruption, memory card detachment or when the memory card reaches the end of its lifespan. No guarantee is provided for such causes.
  - The stored data can be lost if the memory card is not accessed for a long period of time. Back up your data periodically if you seldom access the memory card.
  - Memory cards are expendable and their durability varies according to the conditions of the installed site and how they are used. Back up your data regularly and replace the memory card annually.
  - To avoid power outage, it is highly suggested to apply a battery backup (UPS).
  - For better performance, it is highly suggested to use Micro SD card of MLC NAND flash, Class 10.
  - Replace the memory card when its read/write speed is lower than 6 MB/s or when the memory card is frequently undetected by the camera.

## Packing List

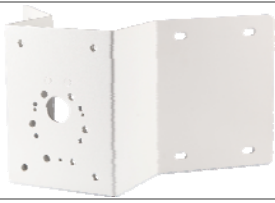
1. Bullet Camera
2. Self Tapping Screw x 3
3. Plastic Screw Anchor x 3
4. Torx Wrench x 3
5. Sun-Shield Cover Kit (1 Sun-Shield Cover, 2 Philips Head Screws, 2 Plastic Screw Spacers and 2 Hexagon Screws included)
6. Silica Gel Bag x 2
7. 2-Pin Terminal Block
8. 3-Pin Terminal Block
9. Power Adapter
10. Installation Sticker
11. Ruler
12. Stand Kit (Conduit Converter, PG21 Conduit Connector, RJ-45 Connector, M3 Screw x 2, Cable Tie)
13. Mounting Kit (M4 Screw x 3, Nut x 3, Plate x 3)
14. GV-IPCAM H.264 Software DVD
15. GV-NVR Software DVD
16. Warranty Card

**Note:** The power adapter can be excluded upon request.

## Accessories

Model No.	Name		Details
GV-Mount300	Convex Corner Adapter Kit		Dimensions: 238.6 x 409.5 mm (9.4" x 16.1") Weight: 4.27 kg (9.41 lb)
GV-Mount310	Concave Corner Adapter Kit		Dimensions: 123.3 x 393.1 mm (4.9" x 15.5") Weight: 2.96 kg (6.53 lb)
GV-Mount400	Pole Mount Bracket Kit (Ø 4" ~ 6")		Dimensions Bracket: 241 x 161 mm (9.5" x 6.3") Weight: 1.70 kg ( 3.75 lb) Steel Strap Diameter: Ø 4" ~ 6"
GV-Mount410	Pole Mount Bracket Kit (Ø 6" ~ 7.5")		Dimensions Bracket: 241 x 161 mm (9.5" x 6.3") Weight: 1.70 kg (3.75 lb) Steel Strap Diameter: Ø 6" ~ 7.5"
GV-PA191 PoE Adapter	Power over Ethernet (PoE) Adapter		The GV-PA191 is a Power over Ethernet (PoE) adapter designed to provide power to the IP device through a single Ethernet cable.
GV-Relay V2	GV-Relay V2		The GV-Relay V2 is designed to expand the voltage load of GV IP devices. It provides 4 relay outputs, and each can be set as normally open (NO) or normally closed (NC) independently as per your requirement.
Power Adapter	Contact your sales representative for the countries and areas supported.		
GV-POE Switch	The GV-POE Switch is designed to provide power along with network connection for IP devices. The GV-POE Switch is available in various models with different numbers and types of ports.		