

E77

10MP Outdoor Dome with D/N, Adaptive IR, Basic WDR, Fixed Lens



- 10 Megapixel with 4K/1080p
- Day & Night with Adaptive IR LED
- Fixed Lens with f3.6mm / F1.8
- Basic WDR (70 dB)
- 30 fps at 1920 x 1080
- Super Wide Angle
- Weatherproof (IP67) and Vandal Proof (IK10)

PHOTO INDICATION

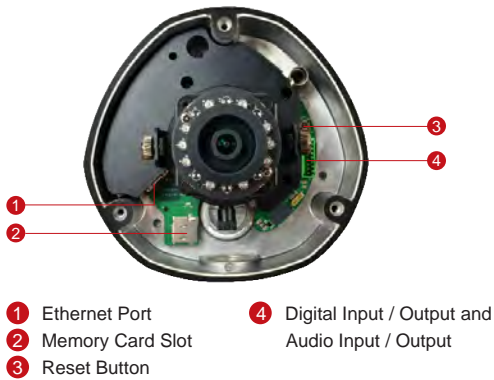

DIMENSION DIAGRAM

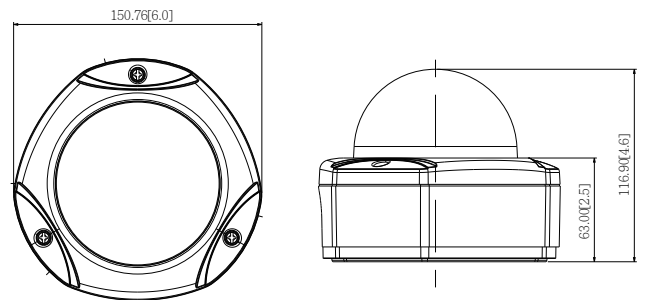







Unit: mm [inch]

ACCESSORY OPTIONS

Dome Cover		
PDCX-1101		4-inch, smoke, vandal proof

Power Supply		
PPOE-0001		IEEE 802.3af PoE Injector for Class 1, 2 or 3 devices, with universal adapter

Popular Mounting Solutions		
Surface	Accessories not required	
Wall	PMAX-0314	
Pendant	PMAX-0101 PMAX-0103	
Corner	PMAX-0314 PMAX-0402	
Pole	PMAX-0314 PMAX-0503	
Flush	PMAX-1003	
Gang Box	PMAX-0804	

* For more mounting solutions, please refer to Project Planner on www.acti.com

PRODUCT SPECIFICATION

E77

• Device

Device Type	Outdoor Dome
Image Sensor	Progressive Scan CMOS
Sensor Size	1/2.3"
Effective Pixels	3856 (H) x 2764 (V) (10.66 MP)
Horizontal Resolution	1450 TVL
Day / Night	Yes
Low Light Sensitivity	Standard
Minimum Illumination	Color: 0.1 lux at F1.8 (30 IRE, 2400°K); B/W: 0 lux (IR LED on)
Color to B/W Switch	ISP based switch, configurable
Mechanical IR Cut Filter	Yes
IR Sensitivity Range	700~1100nm
IR LED	Adaptive IR LED x 10 (850nm)
IR Working Distance	30 m (0 lux, 30 IRE, Gain 255, Auto shutter mode)
Electronic Shutter	1/5 ~ 1/2,000 sec (manual mode); 1/5 ~ 1/10,000 sec (auto mode)
S/N Ratio	52 dB

• Lens

Focal Length / Aperture	Fixed focal, f3.6mm / F1.8
Iris	Fixed iris
Focus	Fixed focus
Mount Type	Board mount
Horizontal Viewing Angle	101.4°
Viewing Angle Adjustment	Pan: 0°~350°; Tilt: 17°~163°; Rotate: 0°~350°

• Video

Compression	H.264 (Baseline / Main / High profile), MJPEG
Max. Frame Rate vs. Resolution	7 fps at 3648 x 2736; 7 fps at 3648 x 2160; 7 fps at 2592 x 1944; 7 fps at 2048 x 1536; 30 fps at 1920 x 1080; 30 fps at 1280 x 720; 30 fps at 800 x 600; 30 fps at 640 x 480; 15 fps at 320 x 240
Multi-Streaming	Simultaneous dual streams based on two configurations
Bit Rate	28 Kbps - 6 Mbps (per stream)
Bit Rate Mode	Constant, Variable
Image Enhancement	Basic WDR (70 dB); White balance: automatic, hold and manual; Brightness; Contrast; Sharpness (auto); Auto gain control; Digital noise reduction; Flickerless
Privacy Mask	4 configurable regions
Text Overlay	User defined text on video
Image Orientation	Image flip and mirror

• Audio

Compression	8kHz, Mono, PCM, 16 bit encoding, G.711
Audio-In	Terminal block
Audio-Out	Terminal block

• Network

Protocol & Service	TCP, UDP, HTTP, HTTPS, DHCP, PPPoE, RTP, RTSP, IPv4, IPv6, DNS, DDNS, NTP, ICMP, ARP, IGMP, SMTP, FTP, UPnP, SNMP, Bonjour
Ethernet Port	1, Ethernet (10/100 Base-T), RJ-45 connector
Security	IP address filtering; HTTPS encryption; Password protected user levels; Anonymous login; IEEE 802.1X network access control

• Alarm

Alarm Trigger	Video motion detection (3 regions); External device through digital input; Sound detection
Alarm Response	Notify control center; Change camera settings; Command other devices; E-mail notification with snapshots; Save video or snapshot to local storage; Upload video or snapshot to FTP Server; Active external device through digital output

• Interface

Digital Input	1, Terminal block
Digital Output	1, Terminal block
Local Storage	MicroSDHC/MicroSDXC memory card slot (card not included)

• General

Power Source / Consumption	PoE Class 2 (IEEE802.3af) / 6.49W (IR on)
Weight	1.006 kg (2.218 lb)
Dimensions (Ø x H)	150.4 mm x 116.9 mm (5.9" x 4.6")
Environmental Casing	Weatherproof (IP67 rated); Vandal proof (IK10 rated); Transparent dome cover
Mount Type	Surface, Pendant, Wall, Corner, Pole, Flush, Gang box
Starting Temperature	-20°C ~ 50°C (-4°F ~ 122°F)
Operating Temperature	-40°C ~ 50°C (-40°F ~ 122°F)
Operating Humidity	10% ~ 85% RH
Approvals	CE (EN 55022 Class B, EN 55024), FCC (Part15 Subpart B Class B), IK10, IP67, NEMA 4X, UL (for optional PoE injector and power adapter)

• Integration

Unified Solution	Fully compatible with ACTi software
ISV Integration	Software Development Kit (SDK) available; ONVIF compliant
Firmware Access Browser	Microsoft Internet Explorer 8.0 or newer (full functionality) Safari with QuickTime installed, and other browsers with VLC installed (partial functionality)
Auto Firmware Upgrade	Yes
GPS Position	Manual Setting

* All specifications are subject to change without notice.

* All brand names and registered trademarks are the property of their respective owners.

www.acti.com

