



Description

The S200 Series miniature circuit breaker offers a compact solution for protection requirements. The S200U AND S200UP devices are UL 489 tested current limiting and DIN rail mounted.

The S200U and S200UP is available with application-specific trip characteristics to provide maximum circuit protection.

The breakers offer thermal-magnetic trip protection according to K and Z characteristics.

For the worldwide market, the breakers carry UL, CSA, IEC, CE and many other agency approvals and certifications.

Features

- UL current limiting
- Fast breaking time (2.3 – 2.5 ms)
- Bus connection system
- Wide range of accessories
- Available with variable depth handle mechanism
- CE certified and marked
- DIN rail mounting
- Finger safe terminals
- Multi-function terminals
- Suitable for reverse feed but S200UDC has polarity
- UL 489 Listed - branch circuit protective device. UL File #E212323

	S200U	S200UP	SU200PR	S200UDC
Amperage	0,2 – 63	0,2 – 25	0,2 – 35A ; 40 – 63A	1 – 63
Voltage	240 VAC	480Y/277VAC	480Y/277 VAC ; 240 VAC	60-125 VDC
Poles	1, 2, 3, 4	1, 2, 3, 4	1, 2, 3, 4	1, 2
Trip characteristics	K, Z	K, Z	K	K, Z
Interrupting ratings	Up to 25 kA: IEC 60947-2 10 kA: UL 489 10 kA: CSA 22.2 No. 5	Up to 25 kA: IEC 60947-2 10 kA: UL 489 10 kA: CSA 22.2 No. 5	10kA: UL489 10kA: CSA 22.2 No.5	14 kA: UL489 14 kA: CSA 22.2 No. 5
Auxiliary contacts	Yes	Yes	Yes	Yes
Bell alarm	Yes	Yes	Yes	Yes
Shunt trip	Yes	Yes	Yes	Yes
Bus bar	Yes	Yes	No	Yes

S200U-K, 240 VAC

Branch circuit protection
UL 489, CSA 22.2 No. 5

K



S201U-K



S202U-K



S203U-K



S204U-K

No. of poles	Rated current	Catalog number	No. of poles	Rated current	Catalog number	
1	0.2	S201U-K0.2	3	0.2	S203U-K0.2	
	0.3	S201U-K0.3		0.3	S203U-K0.3	
	0.5	S201U-K0.5		0.5	S203U-K0.5	
	0.75	S201U-K0.75		0.75	S203U-K0.75	
	1	S201U-K1		1	S203U-K1	
	1.6	S201U-K1.6		1.6	S203U-K1.6	
	2	S201U-K2		2	S203U-K2	
	3	S201U-K3		3	S203U-K3	
	4	S201U-K4		4	S203U-K4	
	5	S201U-K5		5	S203U-K5	
	6	S201U-K6		6	S203U-K6	
	8	S201U-K8		8	S203U-K8	
	10	S201U-K10		10	S203U-K10	
	15	S201U-K15		15	S203U-K15	
	16	S201U-K16		16	S203U-K16	
	20	S201U-K20		20	S203U-K20	
25	S201U-K25	25	S203U-K25			
2	30	S201U-K30	4	30	S203U-K30	
	32	S201U-K32		32	S203U-K32	
	40	S201U-K40		40	S203U-K40	
	50	S201U-K50		50	S203U-K50	
	60	S201U-K60		60	S203U-K60	
	63	S201U-K63		63	S203U-K63	
	0.2	S202U-K0.2		2	0.2	S204U-K0.2
	0.3	S202U-K0.3			0.3	S204U-K0.3
	0.5	S202U-K0.5			0.5	S204U-K0.5
	0.75	S202U-K0.75			0.75	S204U-K0.75
	1	S202U-K1			1	S204U-K1
	1.6	S202U-K1.6			1.6	S204U-K1.6
2	S202U-K2	2	S204U-K2			
3	S202U-K3	3	S204U-K3			
4	S202U-K4	4	S204U-K4			
5	S202U-K5	5	S204U-K5			
6	S202U-K6	6	S204U-K6			
8	S202U-K8	8	S204U-K8			
10	S202U-K10	10	S204U-K10			
15	S202U-K15	15	S204U-K15			
16	S202U-K16	16	S204U-K16			
20	S202U-K20	20	S204U-K20			
25	S202U-K25	25	S204U-K25			
3	30	S202U-K30	4	30	S204U-K30	
	32	S202U-K32		32	S204U-K32	
	40	S202U-K40		40	S204U-K40	
	50	S202U-K50		50	S204U-K50	
	60	S202U-K60		60	S204U-K60	
	63	S202U-K63		63	S204U-K63	

15

Tripping characteristic K

UL 489
240 VAC
10 kA

Inductive loads

- K Curve
- Designed for allowing higher in-rush currents during system start up
- Example: motors, transformers

Accessories & technical data

Accessories – See page 15.9 - 15.13

Technical data – See page 15.14 - 15.16

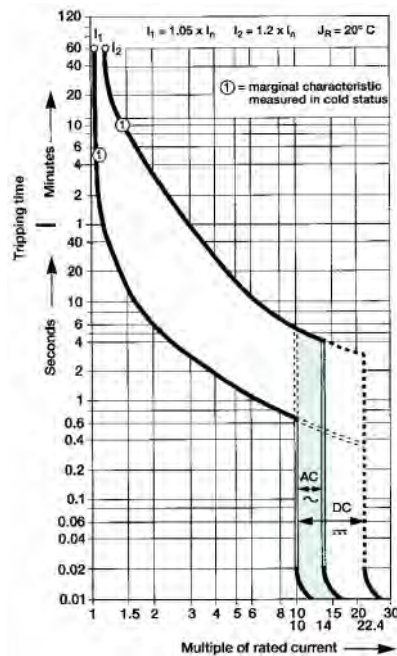

Note: This breaker for AC use only

S200U-Z, 240 VAC

Branch circuit protection

UL 489, CSA 22.2 No. 5

Z



S201U-Z



S202U-Z



S203U-Z



S204U-Z

No. of poles	Rated current	Catalog number	No. of poles	Rated current	Catalog number	
1	0.5	S201U-Z0.5	3	0.5	S203U-Z0.5	
	1	S201U-Z1		1	S203U-Z1	
	1.6	S201U-Z1.6		1.6	S203U-Z1.6	
	2	S201U-Z2		2	S203U-Z2	
	3	S201U-Z3		3	S203U-Z3	
	4	S201U-Z4		4	S203U-Z4	
	5	S201U-Z5		5	S203U-Z5	
	6	S201U-Z6		6	S203U-Z6	
	8	S201U-Z8		8	S203U-Z8	
	10	S201U-Z10		10	S203U-Z10	
	15	S201U-Z15		15	S203U-Z15	
	16	S201U-Z16		16	S203U-Z16	
	20	S201U-Z20		20	S203U-Z20	
	25	S201U-Z25		25	S203U-Z25	
	30	S201U-Z30		30	S203U-Z30	
	2	32		S201U-Z32	4	32
40		S201U-Z40	40	S203U-Z40		
50		S201U-Z50	50	S203U-Z50		
60		S201U-Z60	60	S203U-Z60		
63		S201U-Z63	63	S203U-Z63		
0.5		S202U-Z0.5	4	0.5		S204U-Z0.5
1		S202U-Z1		1		S204U-Z1
1.6		S202U-Z1.6		1.6		S204U-Z1.6
2		S202U-Z2		2		S204U-Z2
3		S202U-Z3		3		S204U-Z3
4	S202U-Z4	4		S204U-Z4		
5	S202U-Z5	5		S204U-Z5		
6	S202U-Z6	6		S204U-Z6		
8	S202U-Z8	8		S204U-Z8		
10	S202U-Z10	10		S204U-Z10		
15	S202U-Z15	15		S204U-Z15		
16	S202U-Z16	16		S204U-Z16		
20	S202U-Z20	20		S204U-Z20		
25	S202U-Z25	25		S204U-Z25		
30	S202U-Z30	30		S204U-Z30		
32	S202U-Z32	32		S204U-Z32		
40	S202U-Z40	40	S204U-Z40			
50	S202U-Z50	50	S204U-Z50			
60	S202U-Z60	60	S204U-Z60			
63	S202U-Z63	63	S204U-Z63			

Tripping characteristic Z

UL 489
240 VAC
10 kA

Resistive loads

- Z Curve
- Designed to provide maximum protection with a very low short circuit trip setting
- Example: semiconductors, control circuits

Accessories & technical data

Accessories – See page 15.9 - 15.13

Technical data – See page 15.14 -15.16

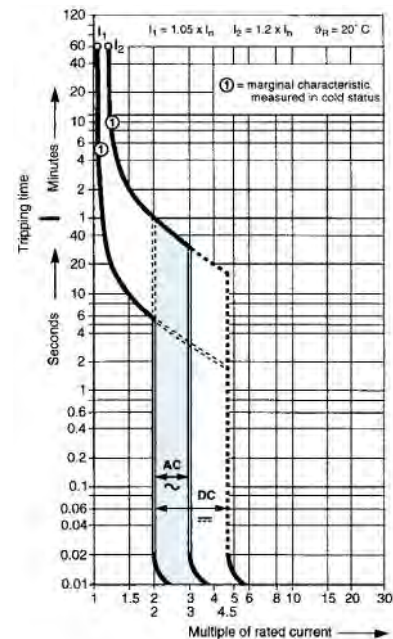

Note: This breaker for AC use only

S200UP-K, 480Y/277 VAC

Branch circuit protection

UL 489, CSA 22.2 No. 5

K



S201UP-K



S202UP-K



S203UP-K



S204UP-K

No. of poles	Rated current	Catalog number	No. of poles	Rated current	Catalog number
1	0.2	S201UP-K0.2	3	0.2	S203UP-K0.2
	0.3	S201UP-K0.3		0.3	S203UP-K0.3
	0.5	S201UP-K0.5		0.5	S203UP-K0.5
	0.75	S201UP-K0.75		0.75	S203UP-K0.75
	1	S201UP-K1		1	S203UP-K1
	1.6	S201UP-K1.6		1.6	S203UP-K1.6
	2	S201UP-K2		2	S203UP-K2
	3	S201UP-K3		3	S203UP-K3
	4	S201UP-K4		4	S203UP-K4
	5	S201UP-K5		5	S203UP-K5
	6	S201UP-K6		6	S203UP-K6
	8	S201UP-K8		8	S203UP-K8
	10	S201UP-K10		10	S203UP-K10
15	S201UP-K15	15	S203UP-K15		
16	S201UP-K16	16	S203UP-K16		
20	S201UP-K20	20	S203UP-K20		
25	S201UP-K25	25	S203UP-K25		
2	0.2	S202UP-K0.2	4	0.2	S204UP-K0.2
	0.3	S202UP-K0.3		0.3	S204UP-K0.3
	0.5	S202UP-K0.5		0.5	S204UP-K0.5
	0.75	S202UP-K0.75		0.75	S204UP-K0.75
	1	S202UP-K1		1	S204UP-K1
	1.6	S202UP-K1.6		1.6	S204UP-K1.6
	2	S202UP-K2		2	S204UP-K2
	3	S202UP-K3		3	S204UP-K3
	4	S202UP-K4		4	S204UP-K4
	5	S202UP-K5		5	S204UP-K5
	6	S202UP-K6		6	S204UP-K6
	8	S202UP-K8		8	S204UP-K8
	10	S202UP-K10		10	S204UP-K10
15	S202UP-K15	15	S204UP-K15		
16	S202UP-K16	16	S204UP-K16		
20	S202UP-K20	20	S204UP-K20		
25	S202UP-K25	25	S204UP-K25		

Tripping characteristic K

UL 489
480Y/277 VAC
10 kA

Inductive loads

- K Curve
- Designed for allowing higher in-rush currents during system start up
- Example: motors, transformers

Accessories & technical data

Accessories – See page 15.9 - 15.13

Technical data – See page 15.14 - 15.16

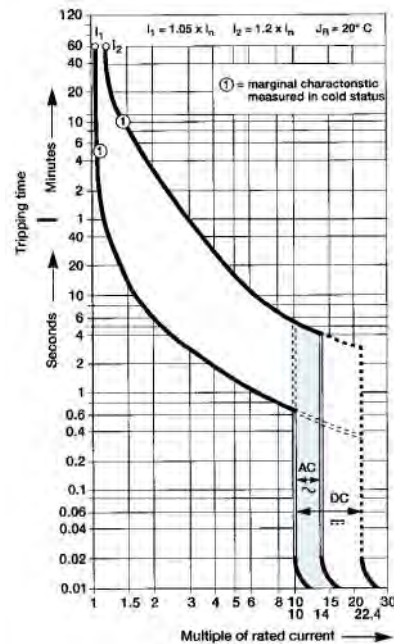

Note: This breaker for AC use only

S200UP-Z, 480Y/277 VAC

Branch circuit protection

UL 489, CSA 22.2 No. 5

Z



S201UP-Z



S202UP-Z



S203UP-Z



S204UP-Z

No. of poles	Rated current	Catalog number	No. of poles	Rated current	Catalog number
1	0.5	S201UP-Z0.5	3	0.5	S203UP-Z0.5
	1	S201UP-Z1		1	S203UP-Z1
	1.6	S201UP-Z1.6		1.6	S203UP-Z1.6
	2	S201UP-Z2		2	S203UP-Z2
	3	S201UP-Z3		3	S203UP-Z3
	4	S201UP-Z4		4	S203UP-Z4
	5	S201UP-Z5		5	S203UP-Z5
	6	S201UP-Z6		6	S203UP-Z6
	8	S201UP-Z8		8	S203UP-Z8
	10	S201UP-Z10		10	S203UP-Z10
	15	S201UP-Z15		15	S203UP-Z15
	16	S201UP-Z16		16	S203UP-Z16
	20	S201UP-Z20		20	S203UP-Z20
25	S201UP-Z25	25	S203UP-Z25		
2	0.5	S202UP-Z0.5	4	0.5	S204UP-Z0.5
	1	S202UP-Z1		1	S204UP-Z1
	1.6	S202UP-Z1.6		1.6	S204UP-Z1.6
	2	S202UP-Z2		2	S204UP-Z2
	3	S202UP-Z3		3	S204UP-Z3
	4	S202UP-Z4		4	S204UP-Z4
	5	S202UP-Z5		5	S204UP-Z5
	6	S202UP-Z6		6	S204UP-Z6
	8	S202UP-Z8		8	S204UP-Z8
	10	S202UP-Z10		10	S204UP-Z10
	15	S202UP-Z15		15	S204UP-Z15
	16	S202UP-Z16		16	S204UP-Z16
	20	S202UP-Z20		20	S204UP-Z20
25	S202UP-Z25	25	S204UP-Z25		

Tripping characteristic Z

UL 489
480Y/277 VAC
10 kA

Resistive loads

- Z Curve
- Designed to provide maximum protection with a very low short circuit trip setting
- Example: semiconductors, control circuits

Accessories & technical data

Accessories – See page 15.9 - 15.13

Technical data – See page 15.14 -15.16

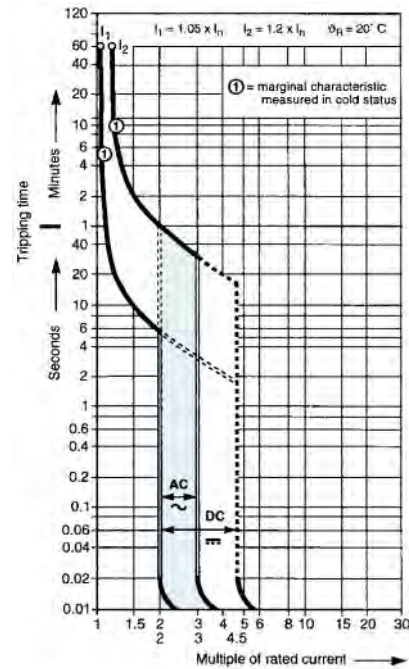

Note: This breaker for AC use only

SU200PR-K, 480Y/277 VAC, Ring tongue

Branch circuit protection

UL489, CSA 22.2 No.5

K



SU201PR-K0.2



SU202PR-K0.2



SU203PR-K0.2



SU204PR-K0.2

No. of poles	Rated current	Catalog number	No. of poles	Rated current	Catalog number
1	0.2	SU201PR-K0.2	3	0.2	SU203PR-K0.2
	0.3	SU201PR-K0.3		0.3	SU203PR-K0.3
	0.5	SU201PR-K0.5		0.5	SU203PR-K0.5
	0.75	SU201PR-K0.75		0.75	SU203PR-K0.75
	1	SU201PR-K1		1	SU203PR-K1
	1.6	SU201PR-K1.6		1.6	SU203PR-K1.6
	2	SU201PR-K2		2	SU203PR-K2
	3	SU201PR-K3		3	SU203PR-K3
	4	SU201PR-K4		4	SU203PR-K4
	5	SU201PR-K5		5	SU203PR-K5
	6	SU201PR-K6		6	SU203PR-K6
	8	SU201PR-K8		8	SU203PR-K8
	10	SU201PR-K10		10	SU203PR-K10
	13	SU201PR-K13		13	SU203PR-K13
	15	SU201PR-K15		15	SU203PR-K15
	16	SU201PR-K16		16	SU203PR-K16
20	SU201PR-K20	20	SU203PR-K20		
25	SU201PR-K25	25	SU203PR-K25		
30	SU201PR-K30	30	SU203PR-K30		
32	SU201PR-K32	32	SU203PR-K32		
35	SU201PR-K35	35	SU203PR-K35		
40	SU201PR-K40	40	SU203PR-K40		
50	SU201PR-K50	50	SU203PR-K50		
60	SU201PR-K60	60	SU203PR-K60		
63	SU201PR-K63	63	SU203PR-K63		
2	0.2	SU202PR-K0.2	4	0.2	SU204PR-K0.2
	0.3	SU202PR-K0.3		0.3	SU204PR-K0.3
	0.5	SU202PR-K0.5		0.5	SU204PR-K0.5
	0.75	SU202PR-K0.75		0.75	SU204PR-K0.75
	1	SU202PR-K1		1	SU204PR-K1
	1.6	SU202PR-K1.6		1.6	SU204PR-K1.6
	2	SU202PR-K2		2	SU204PR-K2
	3	SU202PR-K3		3	SU204PR-K3
	4	SU202PR-K4		4	SU204PR-K4
	5	SU202PR-K5		5	SU204PR-K5
	6	SU202PR-K6		6	SU204PR-K6
	8	SU202PR-K8		8	SU204PR-K8
	10	SU202PR-K10		10	SU204PR-K10
	13	SU202PR-K13		13	SU204PR-K13
	15	SU202PR-K15		15	SU204PR-K15
	16	SU202PR-K16		16	SU204PR-K16
20	SU202PR-K20	20	SU204PR-K20		
25	SU202PR-K25	25	SU204PR-K25		
30	SU202PR-K30	30	SU204PR-K30		
32	SU202PR-K32	32	SU204PR-K32		
35	SU202PR-K35	35	SU204PR-K35		
40	SU202PR-K40	40	SU204PR-K40		
50	SU202PR-K50	50	SU204PR-K50		
60	SU202PR-K60	60	SU204PR-K60		
63	SU202PR-K63	63	SU204PR-K63		

15

Tripping characteristic K

UL 489
480Y/277 VAC
10 kA

Inductive loads

- K Curve
- Designed for allowing higher in-rush currents during system start up
- Example: motors, transformers

Accessories & technical data

Accessories – See page 15.9 - 15.13

Technical data – See page 15.14 - 15.16

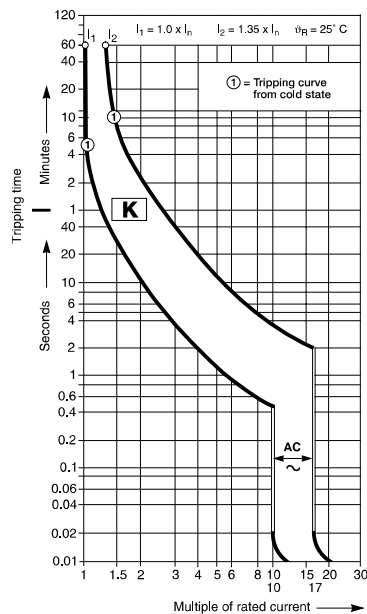

S200UDC-K, 1 pole 60 VDC, 2 pole 125 VDC

Branch circuit protection

UL 489, CSA 22.2 No. 5

K



S201UDC-K1



S202UDC-K1

No. of poles	Rated current	Catalog number	No. of poles	Rated current	Catalog number
1	1	S201UDC-K1	2	1	S202UDC-K1
	1.6	S201UDC-K1.6		1.6	S202UDC-K1.6
	2	S201UDC-K2		2	S202UDC-K2
	3	S201UDC-K3		3	S202UDC-K3
	4	S201UDC-K4		4	S202UDC-K4
	5	S201UDC-K5		5	S202UDC-K5
	6	S201UDC-K6		6	S202UDC-K6
	8	S201UDC-K8		8	S202UDC-K8
	10	S201UDC-K10		10	S202UDC-K10
	13	S201UDC-K13		13	S202UDC-K13
	15	S201UDC-K15		15	S202UDC-K15
	16	S201UDC-K16		16	S202UDC-K16
	20	S201UDC-K20		20	S202UDC-K20
	25	S201UDC-K25		25	S202UDC-K25
	30	S201UDC-K30		30	S202UDC-K30
32	S201UDC-K32	32	S202UDC-K32		
40	S201UDC-K40	40	S202UDC-K40		
50	S201UDC-K50	50	S202UDC-K50		
60	S201UDC-K60	60	S202UDC-K60		
63	S201UDC-K63	63	S202UDC-K63		

NOTE: Standard UL 489 (only DC; please note polarity of device).

Tripping characteristic K

UL 489

480Y/277 VAC

14 kA

Inductive loads

- K Curve
- Designed for allowing higher in-rush currents during system start up
- Example: motors, transformers

Accessories & technical data

Accessories – See page 15.9 - 15.13

Technical data – See page 15.14 -15.16

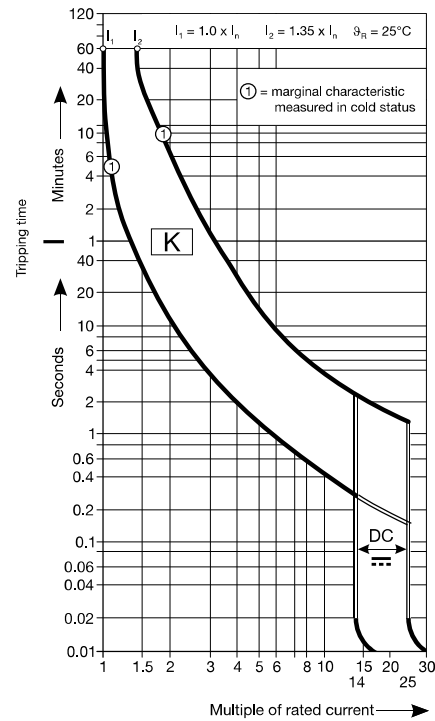

S200UDC-Z, 1 pole 60 VDC, 2 pole 125 VDC

Branch circuit protection

UL 489, CSA 22.2 No. 5

Z



S201UDC-K1



S202UDC-K1

No. of poles	Rated current	Catalog number	No. of poles	Rated current	Catalog number
1	1	S201UDC-Z1	2	1	S202UDC-Z1
	1.6	S201UDC-Z1.6		1.6	S202UDC-Z1.6
	2	S201UDC-Z2		2	S202UDC-Z2
	3	S201UDC-Z3		3	S202UDC-Z3
	4	S201UDC-Z4		4	S202UDC-Z4
	5	S201UDC-Z5		5	S202UDC-Z5
	6	S201UDC-Z6		6	S202UDC-Z6
	8	S201UDC-Z8		8	S202UDC-Z8
	10	S201UDC-Z10		10	S202UDC-Z10
	13	S201UDC-Z13		13	S202UDC-Z13
	15	S201UDC-Z15		15	S202UDC-Z15
	16	S201UDC-Z16		16	S202UDC-Z16
	20	S201UDC-Z20		20	S202UDC-Z20
	25	S201UDC-Z25		25	S202UDC-Z25
	30	S201UDC-Z30		30	S202UDC-Z30
	32	S201UDC-Z32		32	S202UDC-Z32
40	S201UDC-Z40	40	S202UDC-Z40		
50	S201UDC-Z50	50	S202UDC-Z50		
60	S201UDC-Z60	60	S202UDC-Z60		
63	S201UDC-Z63	63	S202UDC-Z63		

NOTE: Standard UL 489 (only DC; please note polarity of device).

Tripping characteristic Z

UL 489
480Y/277 VAC
14 kA

Resistive loads

- Z Curve
- Designed to provide maximum protection with a very low short circuit trip setting
- Example: semiconductors, control circuits

Accessories & technical data

Accessories – See page 15.9 - 15.13

Technical data – See page 15.14 - 15.16

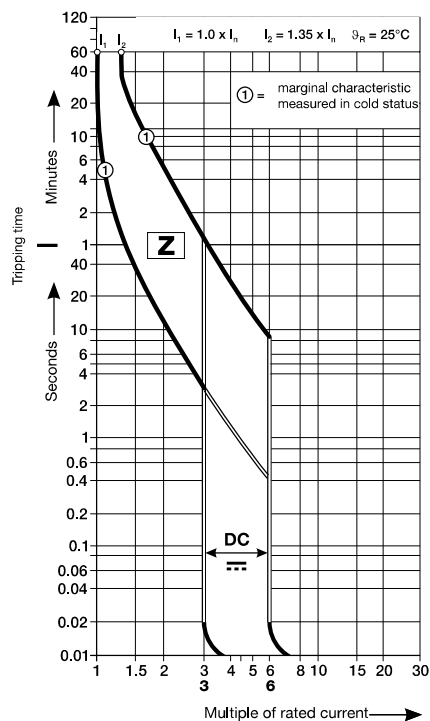

Accessories

S200U, S200UP, SU200PR & S200UDC

UL 489, CSA 22.2 No. 5

Auxiliary contacts

The auxiliary contacts will signal whether the breaker is in the ON or OFF position.

Description	Catalog number
For field mounting: right side	S2C-H6RU



S2C-H6RU

Bell alarm

The bell alarm includes a set of contacts that will only signal when the breaker has tripped. Typically the contacts would be connected to an alarm or bell to signal the operator that an overcurrent trip has occurred. The bell alarm also includes a test button for testing the alarm contacts without opening the breaker.

Description	Catalog number
For field mounting: right side	S2C-S6RU



S2C-S6RU

Rotary operating mechanism

Allows "through the door" operation.

Description	Catalog number
Handle mechanism	S2C-DH



S2C-DH

Shunt trip

For remote tripping of breaker, a shunt trip device can be added to the MCB. The solenoid device opens the breaker after control voltage is applied.

Description	Catalog number
For field mounting: right side 12...60 VAC/DC	S2C-A1U
For field mounting: right side 110...415 VAC 110...250 VDC	S2C-A2U

NOTE: For shafts and handles, refer to parts in the MCCB section.



S2C-A1U

Possible mounting arrangements of MCB accessories

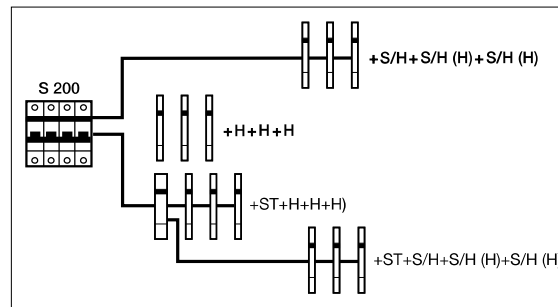

Legend	
Auxiliary contact	H
Bell alarm/Auxiliary contact	S/H
Bell alarm/Auxiliary contact used as auxiliary contact	S/H (H)
Shunt trip	ST

NOTE: Right hand mount accessories cannot be used in conjunction with S2C-DH, Rotary operating mechanism.

Accessories

S200U, S200UP, S200UDC & SU200PR
UL 489, CSA 22.2 No. 5

Connection drawings

Bell alarm S2C-S6RU

In ON and OFF position after hand operation

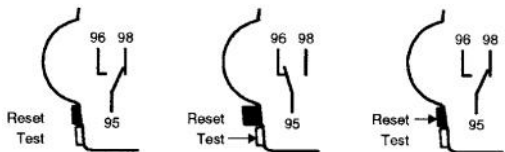

In OFF position after tripping

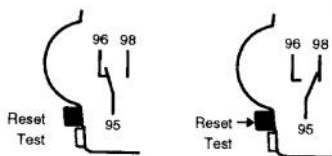

Auxiliary contact S2C-H6RU

Auxiliary contact in ON position



Auxiliary contact in OFF position

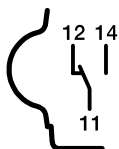

Shunt trip S2C-A...U

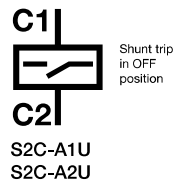

Mounting

Addition of a S2C-H6RU auxiliary contact

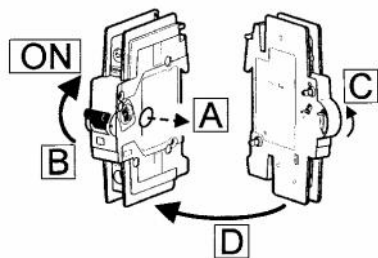

Addition of a S2C-S6RU bell alarm contact

15

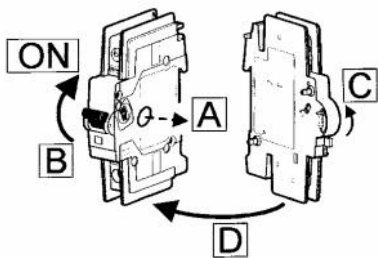

Addition of a S2C-A...U shunt trip

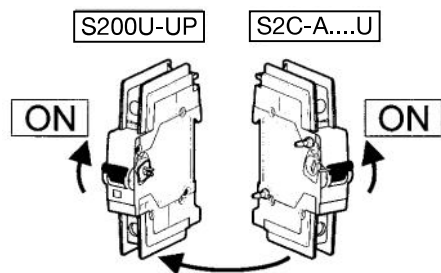

Accessories

SU200PR

UL 489, CSA 22.2 No. 5

SU200PR Accessory overview

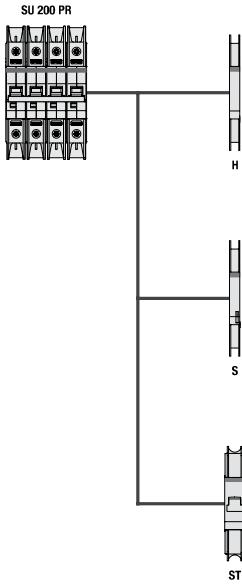

- H Auxiliary contact S2C-H6RU
- S Signal contact S2C-S6RU
- ST Shunt trip S2C-A...U

SU200PR Instructions for use

Ring Tongue Details

Only or ring cable lugs	Rated voltage 480Y/277 V AC	Insulated only 	A max. 11.0 mm (0.43")	B max. 12.2 mm (0.48")	C Suitable for M5 (0.20")
	Rated voltage 240/240 V AC	Insulated only 	A max. 14.0 mm (0.55")	B max. 12.2 mm (0.48")	C Suitable for M5 (0.20")

CU only
 60/75°C
 (140/167°F)

PZ 2 Torque: 2.8 Nm (25lb-in)

Ring Tongue Terminal, Special purpose - Not for general use

Installation Instructions

Please insert or withdraw the cable lug only when the screw is completely open.

Please make sure that the terminal screw penetrates the ring lug hole properly and completely during tightening.

Please ensure that the screw is securely tightened before applying any mechanical force on the cable / cable lug.

Do not apply abnormal downward pressure on the screw during tightening or loosening of the screw.

F = max. 30 N F = Maximum to operate

Please follow the Ring Tongue Details on the rear of this sheet.

Accessories

S200U, S200UP & S200UDC

UL 489, CSA 22.2 No. 5

UL approved busbars UL file # E250145

UL 489 busbar cannot be cut.



PS2/6/16 BP

For use on:	Amp rating	Number of poles	Phases	Busbar length (mm)	Catalog number
S200U	80	6	1	103.2	PS 1/6/16BP
S200UP		12	1	208.8	PS 1/12/16BP
S201UDC		18	1	314.4	PS 1/18/16BP
S200U	80	6	2	103.2	PS 2/6/16BP
S200UP		12	2	208.8	PS 2/12/16BP
S201UDC		18	2	314.4	PS 2/18/16BP
S200U	80	6	3	103.2	PS 3/6/16BP
S200UP		12	3	208.8	PS 3/12/16BP
S201UDC		18	3	314.4	PS 3/18/16BP

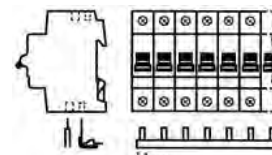

1 Phase

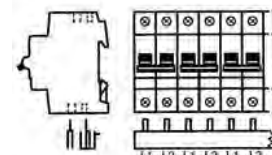

2 Phase

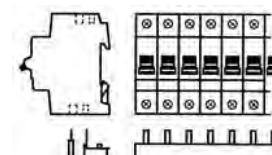

3 Phase



BSK-BP

Busbar tooth covers for BS...BP (UL 489)

Description	Catalog number
Covers three unused poles of busbar	BSK-BP



AST35/15BP



SZ-ESPBP

Feeder terminals for PS...BP (UL 489)

Description	Catalog number
Terminal, insulated with pin contact	AST35/15BP
Feeder Terminal, single-pole terminal, can be mounted side by side, feed on the pin of the busbar	SZ-ESK BP

Technical data

S200U, S200UP, SU200PR & S200UDC

UL 489, CSA 22.2 No. 5

Miniature
circuit breakers
S200

Technical data	S200U	S200UP	SU200PR	S200UDC
Specifications:	UL 489, C 22.2 No. 5, IEC 60947-2			UL 489, VDE 0660
UL File-Number:	E 212323, UL, Current limiting series ratings			E212323, UL
No. of poles:	1, 2, 3 & 4			1, 2
Tripping characteristics:	K, Z		K	K, Z
Rated current:	0.2 (K) 0.5 (Z) ... 63 A	0.2 (K) 0.5 (Z) ... 25 A	0.2 ... 63A	1 - 63 A
Rated voltage:	Single pole: 240VAC Multi pole: 240VAC	Single pole: 277VAC Multi pole: 480Y/277VAC	Single pole: 277VAC (<=35A); 240VAC (>35A) Multi pole: 480Y/277VAC (<=35A); 240VAC (>35A)	1P: 60 V DC 2P:125 V DC ⊕
Short circuit capacity:	10 kA			14 kA
Frequency:	50/60 Hz			50/60 Hz
Degree of protection:	IP 20		IP20, IP40 in enclosure w/cover	IP 20
Mounting position:	Vertical and horizontal		Any	Vertical and horizontal
Fixing:	35 mm DIN rail			35 mm DIN rail
Clamps only for Cu:	18-4 AWG (0.75 ... 25 mm ²)			18-4 AWG (0.75 ... 25 mm ²)
Service life, mech. and at rated load:	20,000 operations		6000 operations (AC) 1 cycle (1s-ON, 9S-OFF)	20,000 operations
Tightening torque:	25 in. lbs (2.8 Nm)			25 in. lbs (2.8 Nm)
Ambient temperature:	- 25 °C ... + 55 °C/- 13 °F ... + 131 °F			- 25 °C ... + 55 °C/- 13 °F ... + 131 °F
Shock resistance:	30 g at least 2 impacts shock, duration 13 ms		25 g, 2 shocks - 13ms	30 g at least 2 impacts shock, duration 13 ms

Auxiliary contact S2C-H6RU and S2C-S6RU

Rated current:	10
Rated voltage AC / DC:	24
Contact:	1 pole double throw
Connection capacity mm ²	18 – 14 AWG (0.75...2.5 mm ²)
Tightening torque:	11 in.lbs (1.2 Nm)
Shock resistance acc. to DIN IEC 68-2-6:	5 g, 20 frequency cycles 5...150...5 Hz at 24 VAC/DC, 5 mA auto-reclosing < 10 ms
Mechanical service life:	10,000 operations

Shunt trip		Type	S2C-A1U	S2C-A2U
Rated voltage	AC	V	12 ... 60	110 ... 415
	DC	V	12 ... 60	110 ... 250
Max. release duration		ms	<10	<10
Min. release voltage	AC	V	7	55
	DC	V	10	80
Consumption on release	AC	VA	40 ... 200	55 ... 210
	DC	VA	40 ... 200	55 ... 110
Coil resistance		Ω	3.7	225
Terminals		AWG/mm ²	18...6 / 0.75 – 16	18...6 / 0.75 – 16
Tightening torque		in.lbs/Nm	18 / 2	18 / 2

⊕ Poles connected in series.

Technical data

S200U, S200UP, SU200PR & S200UDC

UL 489, CSA 22.2 No. 5

Internal resistance and power loss

Internal resistance per pole in mΩ, power loss per pole in W.

Type	Rated current A	Device series K		Device series Z	
		mΩ	W	mΩ	W
S200U S200UP	0.2	42500	1.7	–	–
	0.3	20000	1.8	–	–
	0.5	6340	1.6	10100	2.5
	0.75	2500	1.4	–	–
	1	1400	1.4	2270	2.3
	1.6	625	1.6	1100	2.8
	2	460	1.8	619	2.5
	3	211	1.9	211	1.9
	4	163	2.6	163	2.6
	6	67	2.4	104	3.7
	8	45	2.9	55	3.5
	10	19	1.9	21	2.1
	13	–	–	–	–
	16	8.2	2.1	10.9	2.8
	20	7.3	2.9	7.3	2.9
	25	5.6	3.5	5.6	3.5
	32	4.1	4.2	4.1	4.2
	40	4.0	6.4	4.0	6.4
	50	1.2	3.0	1.8	4.4
	63	1.3	5.2	1.3	5.2

Type	Rated current A	Device series K		Device series Z	
		mΩ	W	mΩ	W
S200UDC	1	1400	1.4	2270	2.3
	1.6	625	1.6	1100	2.8
	2	460	1.8	619	2.5
	3	211	1.9	211	1.9
	4	153	2.6	163	2.5
	6	67	2.4	104	3.7
	8	45	2.9	55	3.5
	10	19	1.9	21	2.1
	13	–	–	–	–
	16	8.2	2.1	10.9	2.8
	20	7.3	2.0	7.3	2.9
	25	5.6	3.5	5.6	3.5
	32	4.1	4.2	4.1	4.2
	40	4.0	6.4	4.0	6.4
	50	1.2	3.0	1.8	4.4
	63	1.3	5.2	1.3	5.2

SU200PR

Rated current A	Internal resistance per pole ¹⁾	
	mΩ	W
0.2	25300	1.01
0.3	13700	1.23
0.5	4740	1.19
0.75	2067	1.16
1	1270	1.27
1.5	610	1.56
2	442	1.77
3	140	1.26
4	109	1.75
5	50	1.26
6	54	1.94
8	22	1.41
10	18.2	1.82
13	14.8	2.50
15	8.1	1.83
16	11.1	2.83
20	8.5	3.40
25	5.5	3.43
30	3.8	3.39
32	4.6	4.70
35	3.9	4.76
40	2.8	4.40
50	1.7	4.25
60	1.7	6.18
63	1.9	7.56

¹⁾ Internal resistances and power loss are subject to application-specific and environment-specific conditions and are therefore to be considered as typical values.

Technical data

S200U, S200UP, SU200PR & S200UDC

UL 489, CSA 22.2 No. 5

Tripping characteristic K (68 °F)

Breaker calibration temperature 68°F
See chart below for temperature DeRating

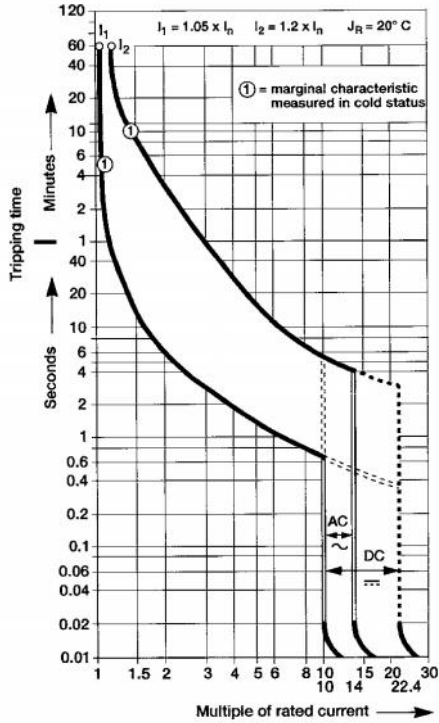

Tripping characteristic Z (68 °F)

Breaker calibration temperature 68°F
See chart below for temperature DeRating

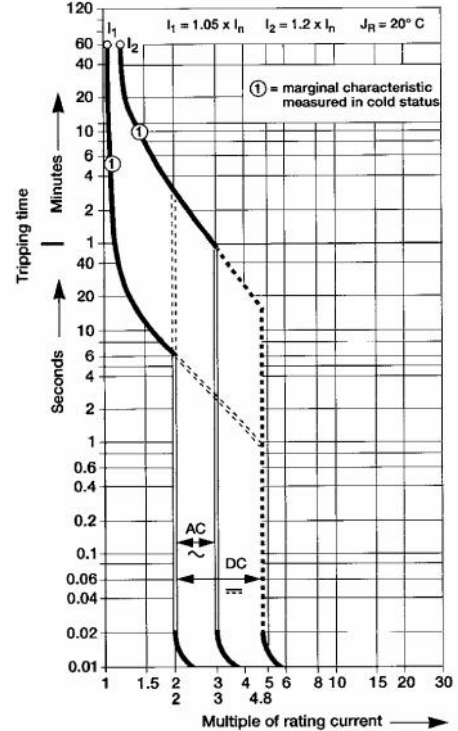

Temperature derating

Max. operating current values depending on the ambient temperature for a circuit-breaker of characteristics type K and Z

K and Z I _n (A)	Ambient temperature T (°C/°F)											
	-40/-40	-30/-22	-20/-4	-10/14	0/32	10/50	20/68	30/86	40/104	50/122	60/140	70/158
0.5	0.66	0.64	0.61	0.59	0.56	0.53	0.50	0.47	0.43	0.40	0.35	0.31
1.0	1.32	1.27	1.22	1.17	1.12	1.06	1.00	0.94	0.87	0.79	0.71	0.61
1.6	2.12	2.04	1.96	1.88	1.79	1.70	1.60	1.50	1.39	1.26	1.13	0.98
2.0	2.65	2.55	2.45	2.35	2.24	2.12	2.00	1.87	1.73	1.58	1.41	1.22
3.0	4.0	3.8	3.7	3.5	3.4	3.2	3.0	2.8	2.6	2.4	2.1	1.8
4.0	5.3	5.1	4.9	4.7	4.5	4.2	4.0	3.7	3.5	3.2	2.8	2.4
6.0	7.9	7.6	7.3	7.0	6.7	6.4	6.0	5.6	5.2	4.7	4.2	3.7
8.0	10.8	10.2	9.8	9.4	8.9	8.5	8.0	7.5	6.9	6.3	5.7	4.9
10.0	13.2	12.7	12.2	11.7	11.2	10.6	10.0	9.4	8.7	7.9	7.1	6.1
13.0	17.2	16.6	15.9	15.2	14.5	13.8	13.0	12.2	11.3	10.3	9.2	8.0
16.0	21.2	20.4	19.6	18.8	17.9	17.0	16.0	15.0	13.9	12.6	11.3	9.8
20.0	26.5	25.5	24.5	23.5	22.4	21.2	20.0	18.7	17.3	15.8	14.1	12.2
25.0	33.1	31.9	30.6	29.3	28.0	26.5	25.0	23.4	21.7	19.8	17.7	15.3
32.0	42.3	40.8	39.2	37.5	35.8	33.9	32.0	29.9	27.7	25.3	22.6	19.6
40.0	52.9	51.0	49.0	46.9	44.7	42.4	40.0	37.4	34.6	31.6	28.3	24.5
50.0	66.1	63.7	61.2	58.6	55.9	53.0	50.0	46.8	43.3	39.5	35.4	30.6
63.0	83.3	80.3	77.2	73.9	70.4	66.8	63.0	58.9	54.6	49.8	44.5	38.6

Approximate dimensions

S200U, S200UP, S200UDC & SU200PR
UL 489, CSA 22.2 No. 5

Approximate dimensions in mm

S200U

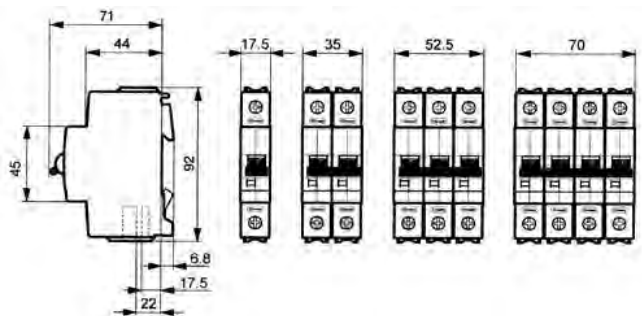

S200UDC

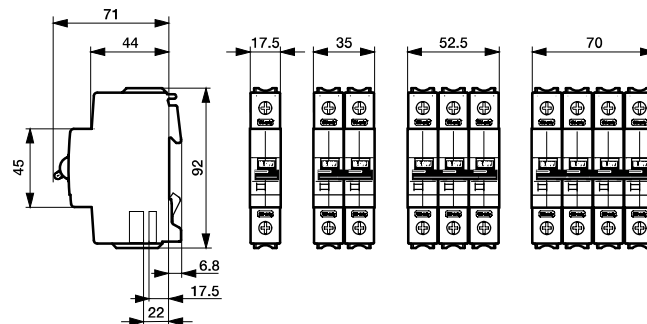

S200UP

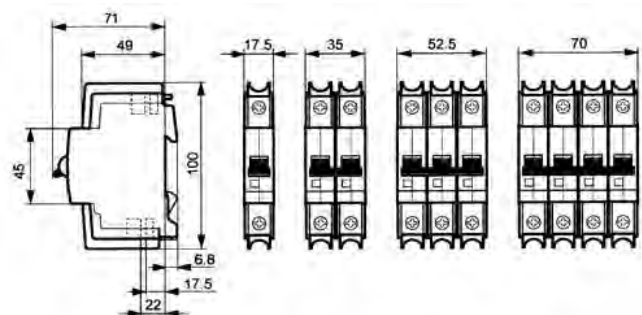

SU200PR

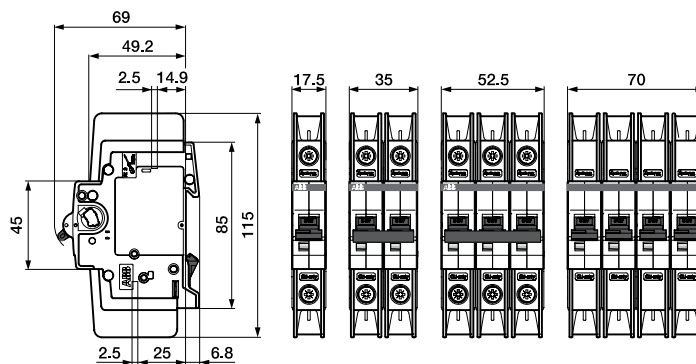

S2C-H6RU, S2C-S6RU S2C-A..U

