

AMX-32T2/28-C2

2MP HD Turret Analog Camera



- 2 MP, 1920 × 1080 resolution
- 2.8 mm, 3.6 mm, 6 mm fixed focal lens
- 4 in 1 video output (switchable TVI/AHD/CVI/CVBS)
- Smart IR, up to 25 m IR distance
- IP67

Specification

Camera	
Image Sensor	2 MP CMOS
Signal System	PAL/NTSC
Resolution	1920 (H) × 1080 (V)
Frame Rate	TVI: 1080P@30fps, 1080P@25fps CVI: 1080P@30fps, 1080P@25fps AHD: 1080P@30fps, 1080P@25fps CVBS: PAL/NTSC
Min. illumination	0.01 Lux@(F1.2, AGC ON), 0 Lux with IR
Shutter Time	PAL: 1/25 s to 1/50, 000 s NTSC: 1/30 s to 1/50, 000 s
Lens	2.8 mm, 3.6 mm, 6 mm fixed lens
Field of View	2.8 mm, horizontal FOV: 101°, vertical FOV: 60°, diagonal FOV: 122° 3.6 mm, horizontal FOV: 79.6°, vertical FOV: 43.5°, diagonal FOV: 93.7° 6 mm, horizontal FOV: 51.9°, vertical FOV: 30°, diagonal FOV: 58.8°
Lens Mount	M12
Day & Night	ICR
WDR (Wide Dynamic Range)	Digital WDR
Angle Adjustment	Pan: 0 to 360°, Tilt: 0 to 75°, Rotation: 0 to 360°
Menu	
Image Mode	STD/HIGH-SAT
AGC	Yes
Day/Night Mode	Auto/Color/BW (Black and White)
White Balance	Auto/Manual
AE (Auto Exposure) Mode	DWDR/BLC/HLC/Global
Noise Reduction	2D DNR
Language	English
Function	Brightness, Sharpness, Smart IR
Interface	
Video Output	Switchable TVI/AHD/CVI/CVBS
General	
Operating Conditions	-40 °C to 60 °C (-40 °F to 140 °F), humidity 90% or less (non-condensing)
Power Supply	12 VDC ± 25%
Power Consumption	Max. 3 W
Protection Level	IP67
Material	Metal
IR Range	Up to 25 m
Communication	N/A
Dimensions	89.47 mm × 67.6 mm (3.52" × 2.70")

Weight

Approx. 250 g (0.55 lb.)

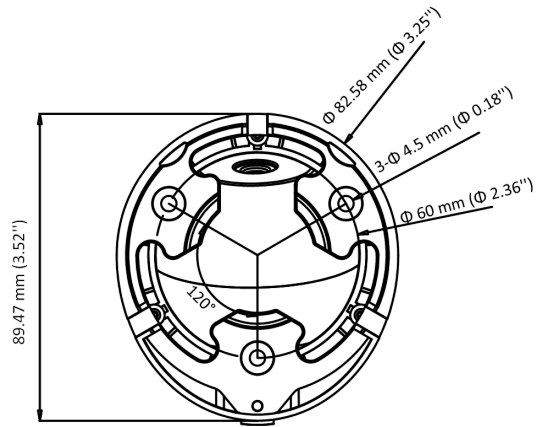
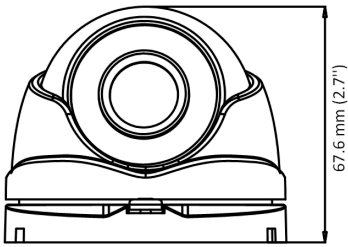

Accessory

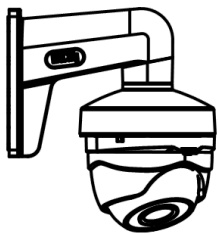
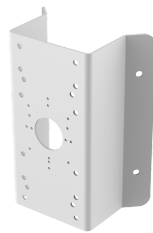
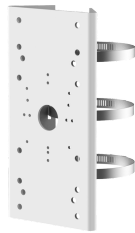

ES1272ZJ-110-TRS
Wall Mount

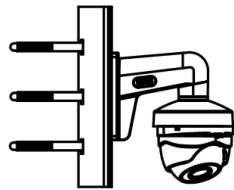

ES1275ZJ-SUS
Vertical Pole
Mount

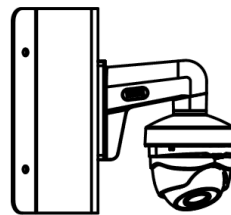

ES1276ZJ-SUS
Corner Mount

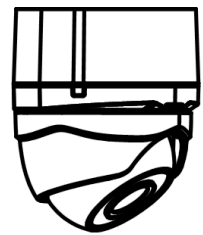

ES1280ZJ-XS
Junction Box