

## AMX-35T4/G28-HC

5MP Fixed Turret Long IR 4-IN-1 Coaxial Security Camera



- 5 MP, 2560 × 1944 resolution
- 2.8 mm, 3.6 mm, 6 mm, 8 mm, 12 mm fixed focal lens
- Smart IR, up to 40 m IR distance
- 4 in 1 video output (switchable TVI/AHD/CVI/CVBS)
- IP67

## Specification

Camera	
Image Sensor	5 MP CMOS
Signal System	PAL/NTSC
Resolution	2560 (H) × 1944 (V)
Frame Rate	TVI: 5M@20fps, 4M@30fps, 4M@25fps, 1080p@30fps, 1080p@25fps AHD: 5M@20fps, 4M@30fps, 4M@25fps CVI: 4M@30fps, 4M@25fps CVBS: PAL/NTSC
Min. illumination	0.01 Lux@(F1.2, AGC ON), 0 Lux with IR
Shutter Time	PAL: 1/25 s to 1/50, 000 s NTSC: 1/30 s to 1/50, 000 s
Lens	2.8 mm, 3.6 mm, 6 mm, 8 mm, 12 mm fixed lens
Field of View	2.8 mm, horizontal FOV: 85°, vertical FOV: 63°, diagonal FOV: 110° 3.6 mm, horizontal FOV: 80°, vertical FOV: 63°, diagonal FOV: 105° 6 mm, horizontal FOV: 57°, vertical FOV: 43°, diagonal FOV: 72° 8 mm, horizontal FOV: 41°, vertical FOV: 31°, diagonal FOV: 52° 12 mm, horizontal FOV: 26°, vertical FOV: 19°, diagonal FOV: 32°
Lens Mount	M12
Day & Night	ICR
WDR (Wide Dynamic Range)	Digital WDR
Angle Adjustment	Pan: 0 to 360°, Tilt: 0 to 75°, Rotation: 0 to 360°
Menu	
Image Mode	STD/HIGH-SAT
AGC	Yes
Day/Night Mode	Auto/Color/BW (Black and White)
White Balance	Auto/Manual
AE (Auto Exposure) Mode	DWDR/BLC/HLC/Global
Noise Reduction	2D DNR
Language	English
Function	Brightness, Sharpness, Mirror, Smart IR
Interface	
Video Output	Switchable TVI/AHD/CVI/CVBS
General	
Operating Conditions	-40 °C to 60 °C (-40 °F to 140 °F), humidity 90% or less (non-condensing)
Power Supply	12 VDC ± 25%
Power Consumption	Max. 4.3 W
Protection Level	IP67
Material	Front Cover: Plastic Main Body: Metal
IR Range	Up to 40 m

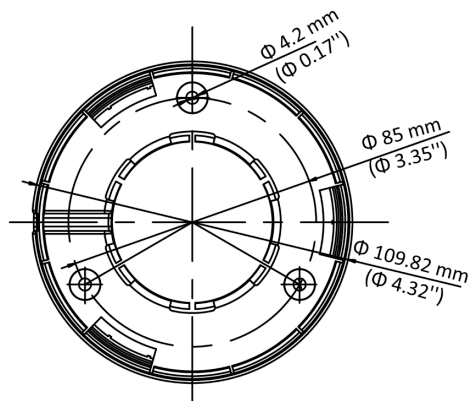
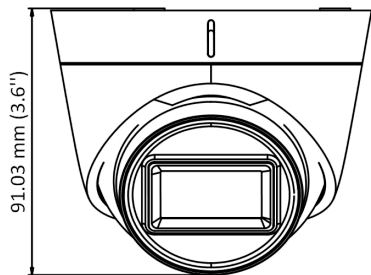

**Accessory**

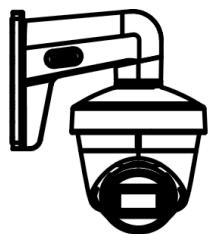

**ES1272ZJ-110-TRS**  
Wall Mount

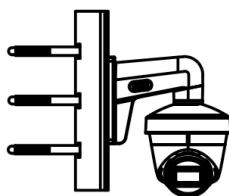
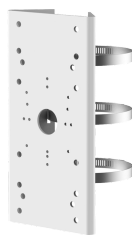

**ES1275ZJ-SUS**  
Vertical Pole  
Mount

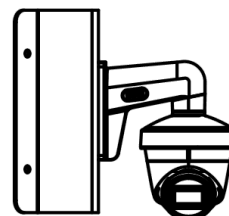
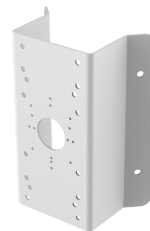

**ES1276ZJ-SUS**  
Corner Mount

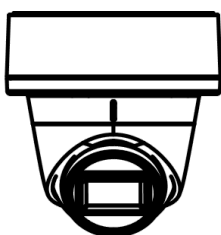

**DS-1280ZJ-S**  
Junction Box



**DS-1281ZJ-S**  
Inclined Ceiling Mount

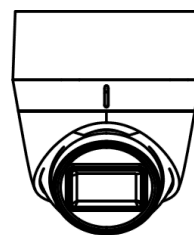

**DS-1280ZJ-TR13**  
Junction Box