

GV-TDR2704 2MP H.265 Low Lux WDR Pro IR Mini Fixed Rugged IP Dome



- 1/2.7" progressive scan low lux CMOS sensor
- Min. illumination at 0.01 lux
- Dual streams from H.265, H.264 or MJPEG
- Up to 30 fps at 1920 x 1080
- Intelligent IR
- IR distance up to 30 m (100 ft)
- Built-in micro SD card slot (SD / SDHC / SDXC / UHS-I, Class 10) for local storage
- 3-axis mechanism (pan / tilt / rotate)
- Day and night function (with removable IR-cut filter)
- Ingress protection (IP67)
- Vandal Resistance (IK10)
- DC 12 V / PoE (IEEE 802.3af)
- Wide Dynamic Range (WDR Pro)
- Defog
- 3D noise reduction
- Motion detection
- Text overlay
- Privacy mask
- 12 languages supported
- ONVIF (Profile G, S, T) conformant

Introduction

The Mini Fixed Rugged IP Dome is an outdoor, fixed, network camera equipped with an automatic IR-cut filter and an IR LED for day and night surveillance. The camera supports H.265 video codec to achieve better compression ratio while maintaining high quality pictures at reduced network bandwidths. It adheres to IP67 and IK10 standards, and can be powered through PoE.

Models

Model	Iris	Focal Length (mm)	Horizontal FOV	Maximum Aperture	Image Format
GV-TDR2704-2F	Fixed	2.8 mm	113°	F/2.0	1/2.7"
GV-TDR2704-4F		4.0 mm	91°		

Dimensions

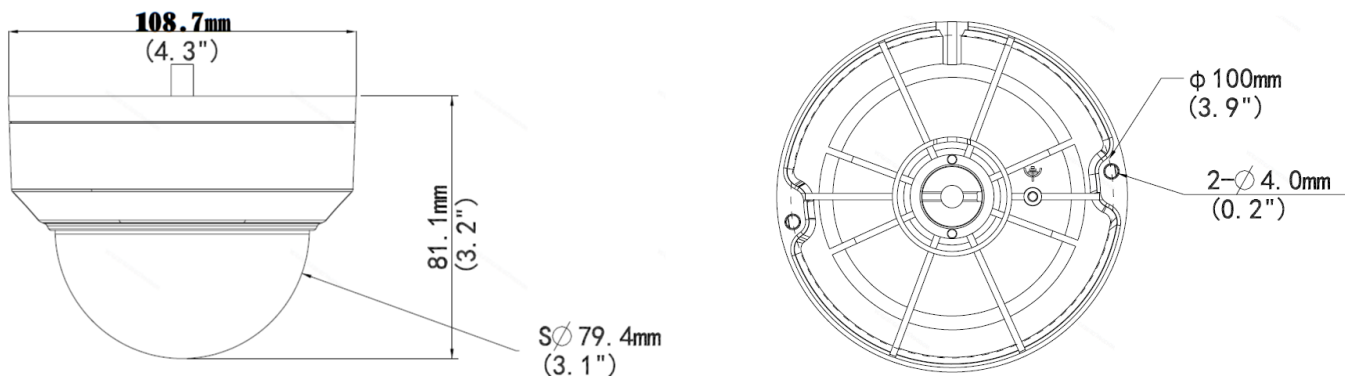

Specifications

Camera					
Image Sensor		1/2.7" progressive scan low lux CMOS			
Picture Elements		1920 (H) x 1080 (V)			
Minimum Illumination	Color	0.01 Lux (F2.0, AGC ON)			
	IR ON	0 Lux			
Shutter Speed		Auto / Manual (1 ~ 1/100,000 sec)			
White Balance		Auto / Manual			
Gain Control		Auto / Manual			
S/N Ratio		52 dB			
WDR Pro		Yes			
Dynamic Range		Up to 120 dB			
Lens		GV-TDR2704-2F	GV-TDR2704-4F		
Megapixel		Yes			
Day / Night		Yes (with removable IR-cut filter)			
Lens Type		Fixed			
Focal Length		2.8 mm	4 mm		
Maximum Aperture		F/2.0			
Mount		M12			
Horizontal FOV		113°	91°		
Operation	Focus	Fixed			
	Zoom				
	Iris				
IR LED Quantity		1 IR LED			
Max. IR Distance		30 m (100 ft)			
DORI		Detect	Observe	Recognize	Identify
Lens	2.8 mm	42 m (137.8 ft)	16.8 m (55.1 ft)	8.4 m (27.6 ft)	4.2 m (13.8 ft)
Operation					
Video Compression		H.265, H.264, MJPEG			
Video Streaming		Dual streams from H.265, H.264 or MJPEG			
Video Resolution	Main Stream	1920 x 1080 (Default), 1280 x 720			
	Sub Stream	1280 x 720, 720 x 576, 704 x 288, 640 x 480, 640 x 360 (Default), 352 x 288			
Frame Rate		30 fps at 1920 x 1080 (60 / 50 Hz) * The frame rate and performance may vary depending on the number of connections and data bitrates (different scenes).			
Video Analytics		Motion Detection, Tampering Alarm, Crossing line, Intrusion. *Tampering alarm, Cross Line, and Intrusion are only accessible through the camera's Web interface, which can be used to trigger alerts such as e-mail and FTP			
Image Setting		Brightness, Contrast, Saturation, Sharpness, Flicker-less, Image Orientation (Flip, Mirror, 0°, 90°, 180°, 270°-including Corridor format)			
Network					
Interface		10/100 Ethernet			
Protocol		802.1x, ARP, DHCP, DDNS, DNS, DynDNS, FTP, HTTP, HTTPS, ICMP, IGMP, IPv4, NTP, PPPoE, QoS, RTCP, RTP, RTSP, SMTP, SNMP, TCP, UDP, UPnP, ONVIF (Profile G, S, T)			
Mechanical					
Temperature Detector		No			
Camera Angle Adjustment	Pan	3° ~ 360°			
	Tilt	0° ~ 68°			
	Rotate	3° ~ 360			
Connectors	Power	DC Jack (DC 12 V, 1.25 A), PoE			
	Ethernet	RJ-45 connector			
	Local Storage	Micro SD card slot (SD / SDHC / SDXC / UHS-I, Class 10) *UHS-II card type is not supported.			
General					
Operating Temperature		-30 °C ~ 60 °C (-22 °F ~ 140 °F)			
Humidity		10% ~ 90% (no condensation)			
Power Source		12 V DC / PoE (IEEE802.3af)			

Max. Power Consumption	5.0 W
Dimensions	Ø 108.7 x 81.1 mm (Ø 4.3" x 3.2")
Weight	0.36 kg (0.79 lb)
Ingress Protection	IP67
Vandal Resistance	IK10
Certification	FCC, CE, RoHS, UL compliant

Web Interface

Installation Management	Web-based configuration
Maintenance	Firmware upgrade through Web Browser or GV-IP Device Utility
Access from Web Browser	Live View, Video Recording, Change Video Quality, Bandwidth Control, Image Snapshot, Defog, Text Overlay, Image Masking
Language	Czech, English, French, German, Hungarian, Italian, Japanese, Polish, Portuguese, Russian, Spanish, Traditional Chinese

Applications

Software Supported	GV-VMS (V17.4.1 / V18.2.1), GV-DVR / NVR (V8.9.1), GV-Control Center (V3.8.0), GV-Recording Server / Video Gateway (V1.4.0), GV-Edge Recording Manager Win version (V2.0.0), GV-Redundant / Failover Server (V1.1.0.0), GV-Mobile Server (V1.5.1)
Live Viewing	Browser (IE, Edge, Chrome, Firefox, Safari), Mobile App





Note:





1. It is required to apply patch files to some or all of the supported software.
2. Do not use clothes or any ordinary material to clean the camera cover since they may result in scratches.
3. Specifications are subject to change without notice.

Packing List

- | | |
|--------------------------|--------------------------|
| 1. GV-TDR2704 Dome | 5. Drill Template Paster |
| 2. Waterproof Rubber Set | 6. Download Guide |
| 3. Screw Kit | 7. Warranty Card |
| 4. Torx Wrench | |

Accessories

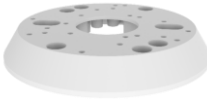
Model No.	Name		Details
GV-Mount107 (must be used with GV-Mount213)	Pendant Bracket		Dimensions: Ø 120 x 334 mm (Ø 4.72" x 13.15") Weight: 0.74 kg (1.63 lb)
GV-Mount211P	Wall Mount and Junction Box		Dimensions: Ø 233 x 125 x 125 mm (Ø 9.2" x 4.9" x 4.9") Weight: 1 kg (2.2 lb)
GV-Mount213	Wall / Ceiling Box Mount		Dimensions: Ø 109 x 39 mm (Ø 4.3" x 1.5") Weight: 0.2 kg (0.44 lb)
GV-Mount300-2	Convex Corner Mount		Dimensions: 137 x 233 x 160 mm (5.4" x 9.17" x 6.3") Weight: 1.65 kg (3.64 lb)
GV-Mount310-2	Concave Corner Mount		Dimensions: 111.2 x 369.9 x 210 mm (2.6" x 11.4" x 6.6") Weight: 1.65 kg (3.64 lb)

<p>GV-Mount420 (must be used with GV-Mount211P)</p>	<p>Pole Mount Bracket</p>		<p>Dimensions: Ø 120 x 120 x 53.4 mm (Ø 4.7" x 4.7" x 2.1") Weight: 0.45 kg (0.99 lb) Steel Strap Diameter: Ø 67 ~ 127 mm (Ø 2.6" ~ 5")</p>
<p>GV-Mount704 (must be used with GV-Mount107)</p>	<p>Extension Tube</p>		<p>Dimensions: Ø 3.5 x 10 or 20 or 30 or 50 cm (Ø 1.38 x 3.9 or 7.9 or 11.8 or 19.7") Weight: 225g or 360g or 500g or 780g (0.5 lb or 0.79 lb or 1.1 lb or 1.72 lb)</p>
<p>GV-Mount924 (for standard US single and double gang boxes only)</p>	<p>Power Box Mount Bracket</p>		<p>Dimensions: Ø 128 x 18.5 mm (Ø 5" x 0.7") Weight: 0.15 kg (0.33 lb)</p>
<p>GV-PA191</p>	<p>Power over Ethernet (PoE) Adapter</p>		<p>The GV-PA191 is a Power over Ethernet (PoE) adapter designed to provide power to the IP device through a single Ethernet cable.</p>
<p>GV-POE Switch</p>	<p>The GV-POE Switch is designed to provide power along with network connection for IP devices. The GV-POE Switch is available in various models with different numbers and types of ports.</p>		
<p>Power Adapter</p>	<p>Contact our sales representatives for the countries and areas supported.</p>		