

MEGApix® 4 Megapixel Surface Mount Dome Camera DWC-MV84WiA



User's Manual Ver. 12/16

Before installing and using the camera, please read this manual carefully.
Be sure to keep it handy for future reference.

Safety Information



CAUTION

RISK OF ELECTRIC SHOCK.
DO NOT OPEN.



CAUTION:

TO REDUCE THE RISK OF ELECTRIC SHOCK, DO NOT REMOVE COVER (OR BACK) NO USER SERVICEABLE PARTS INSIDE. REFER SERVICING TO QUALIFIED SERVICE PERSONNEL.



Warning

This symbol indicates that dangerous voltage consisting a risk of electric shock is present within this unit.



Precaution

This exclamation point symbol is intended to alert the user to the presence of important operating and maintenance (servicing) instructions in the literature accompanying the appliance.

WARNING

To prevent damage which may result in fire or electric shock hazard, do not expose this appliance to rain or moisture.

WARNING

1. Be sure to use only the standard adapter that is specified in the specification sheet. Using any other adapter could cause fire, electrical shock, or damage to the product.
2. Incorrectly connecting the power supply or replacing battery may cause explosion, fire, electric shock, or damage to the product.
3. Do not connect multiple cameras to a single adapter. Exceeding the capacity may cause excessive heat generation or fire.
4. Securely plug the power cord into the power receptacle. Insecure connection may cause fire.
5. When installing the camera, fasten it securely and firmly. A falling camera may cause personal injury.
6. Do not place conductive objects (e.g. screw drivers, coins, metal items, etc.) or containers filled with water on top of the camera. Doing so may cause personal injury due to fire, electric shock, or falling objects.
7. Do not install the unit in humid, dusty, or sooty locations. Doing so may cause fire or electric shock.
8. If any unusual smells or smoke come from the unit, stop using the product. Immediately disconnect the power source and contact the service center. Continued use in such a condition may cause fire or electric shock.
9. If this product fails to operate normally, contact the nearest service center. Never disassemble or modify this product in any way.
10. When cleaning, do not spray water directly onto parts of the product. Doing so may cause fire or electric shock.

Precaution

Operating

- Before using, make sure power supply and all other parts are properly connected.
- While operating, if any abnormal condition or malfunction is observed, stop using the camera immediately and contact your dealer.

Handling

- Do not disassemble or tamper with parts inside the camera.
- Do not drop the camera or subject it to shock or vibration as this can damage the camera.
- Clean the clear dome cover with extra care. Scratches and dust can ruin the quality of the camera image.

Installation and Storage

- Do not install the camera in areas of extreme temperature, exceeding the allowed range.
- Avoid installing in humid or dusty environments.
- Avoid installing in places where radiation is present.
- Avoid installing in places where there are strong magnetic fields and electric signals.
- Avoid installing in places where the camera would be subject to strong vibrations.
- Never expose the camera to rain or water.

Important Safety Instructions

1. **Read these instructions.** - All these safety and operating instructions should be read before the product is installed or operated.
2. **Keep these instructions.** - The safety, operating and use instructions should be retained for future reference.
3. **Heed all warnings.** - All warnings on the product and in the operating instructions should be adhered to.
4. **Follow all instructions.** - All operating and use instructions should be followed.
5. **Do not use this device near water.** - For example: near a bath tub, wash bowl, kitchen sink, laundry tub, in a wet basement; near a swimming pool; etc.
6. **Clean only with dry cloth.** - Unplug this product from the wall outlet before cleaning. Do not use liquid cleaners.
7. **Do not block any ventilation openings. Install in accordance with the manufacturer's instructions.** - Slots and openings in the cabinet are provided for ventilation, to ensure reliable operation of the product, and to protect it from over-heating. The openings should never be blocked by placing the product on bed, sofa, rug or other similar surface. This product should not be placed in a built-in installation such as a bookcase or rack unless proper ventilation is provided and the manufacturer's unstructions have been adhere to.
8. **Do not install near any heat sources such as radiators, heat registers, or other apparatus (including amplifiers) that produce heat.**
9. **Do not defeat the safety purpose of the polarized or grounding-type plug.** A polarized plug has two blades with one wider than the other. A grounding type plug has two blades and a third grounding prong. The wide blade or the third prong are provided for your safety. If the provided plug does not fit into your outlet, consult an electrician for replacement of the obsolete outlet.
10. **Protect the power cord from being walked on or pinched particularly at plugs, convenience receptacles, and the point where they exit from the apparatus.**
11. **Only use attachments/accessories specified by the manufacturer.**
12. **Use only with cart, stand, tripod, bracket, or table specified by the manufacturer, or sold with the apparatus. When a cart is used, use caution when moving the cart/apparatus combination to avoid injury from tip-over.**
13. **Unplug this apparatus during lightning storms or when unused for long periods of time.**
14. **Refer all servicing to qualified service personnel.** Servicing is required when the apparatus has been damaged in any way, such as power supply cord or plug is damaged, liquid has been spilled or objects have fallen into the apparatus, the apparatus has been exposed to rain or moisture, does not operate normally, or has been dropped.





Disposal of Old Appliances

1. When this crossed-out wheel bin symbol is attached to a product it means the product is covered by the European Directive 2002/96/EC.
2. All electrical and electronic products should be disposed of separately from the municipal waste stream in accordance to laws designated by the government or the local authorities.
3. The correct disposal of your old appliance will help prevent potential negative consequences for the environment and human health.
4. For more detailed information about disposal of your old appliance, please contact your city office, waste disposal service or the shop where you purchased the product.



This equipment has been tested and found to comply with the limits for a Class A digital device, pursuant to part 15 of the FCC Rules. These limits are designed to provide reasonable protection against harmful interference when the equipment is operated in a commercial environment. This equipment generates, uses, and can radiate radio frequency energy and, if not installed and used in accordance with the instruction manual, may cause harmful interference to radio communications. Operation of this equipment in a residential area is likely to cause harmful interference in which case the user will be required to correct the interference at his own expense.

Introduction - Product & Accessories

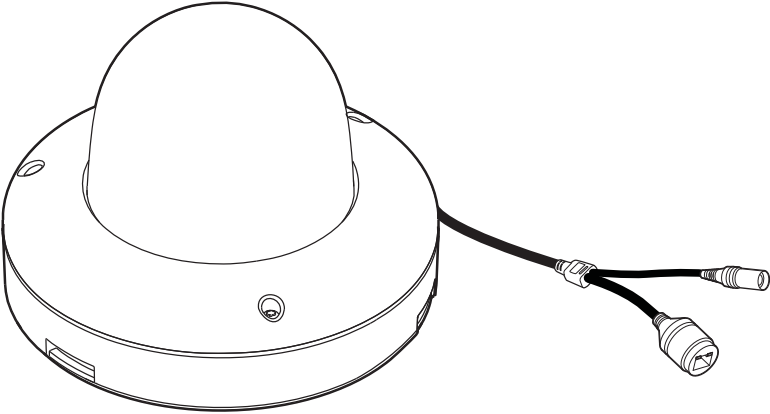

Camera



Torx Wrench

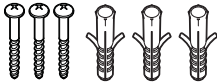

Screw &
Plastic Anchor-3pcs

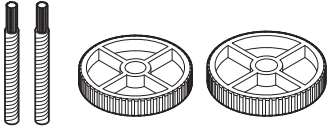

Mount Bolt & Nut

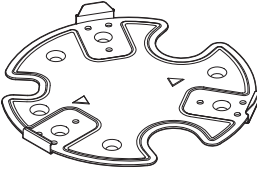

Mount Plate

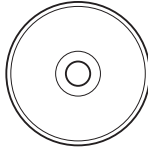

Manual CD

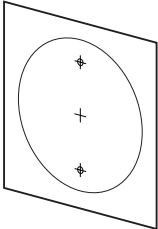

Template Sheet
for Installing by Bolt & Nut

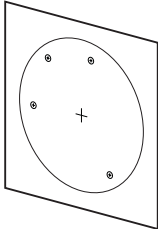

Template Sheet
for Installing by Plate



Quick Manual



Test Monitor Cable

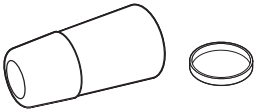

Waterproof cap & Gasket

Introduction - Part Name

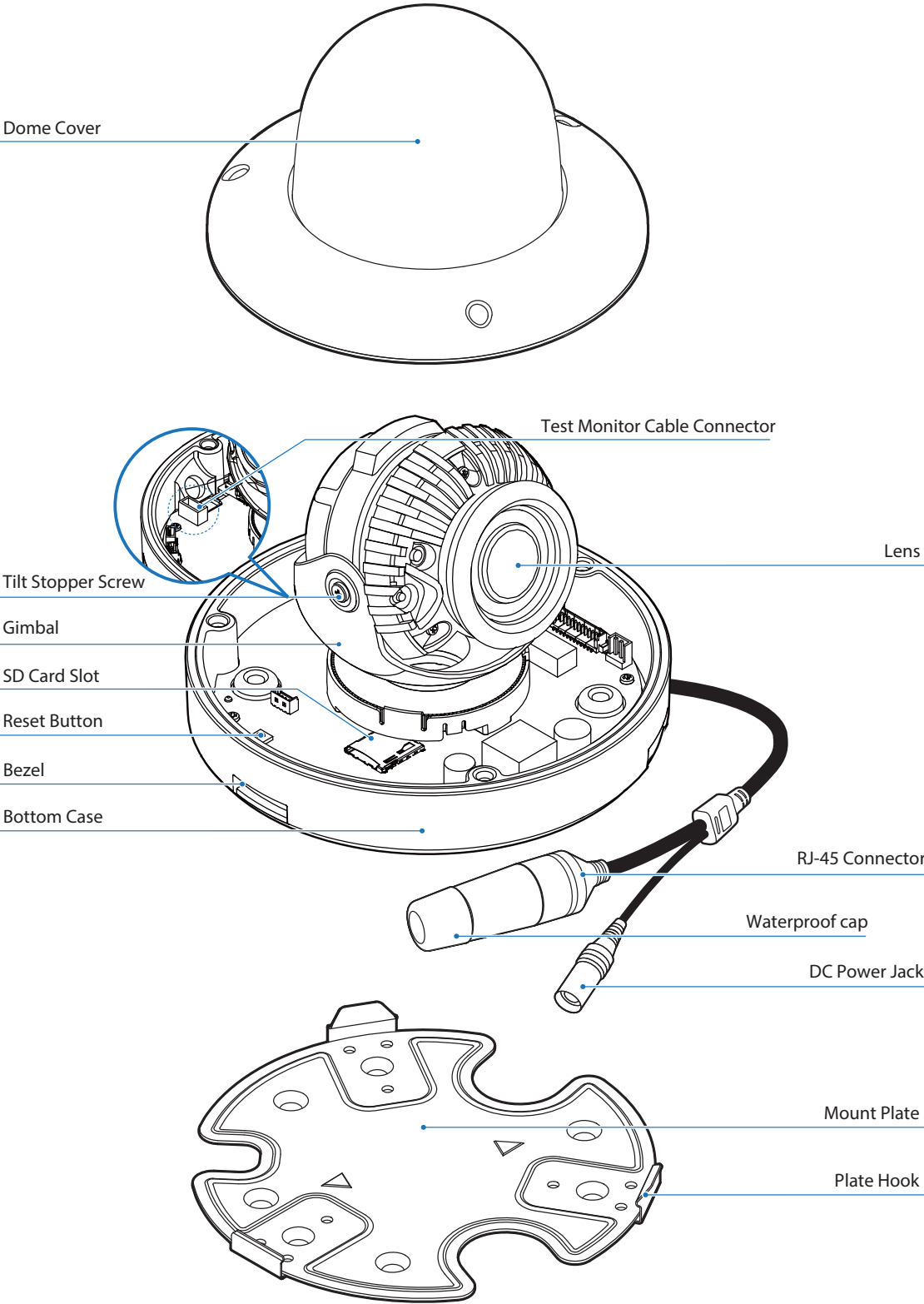

Installation - Disassemble the camera

Before installing your camera, you have to read the following cautions.

1. You have to check whether the location can bear five times of the weight of your camera.
2. Don't let the cable to be caught in improper place or the electric line cover to be damaged. Otherwise it may cause a breakdown or fire.
3. When installing your camera, don't allow any person to approach the installation site. If you have any valuable things under the place, move them away.

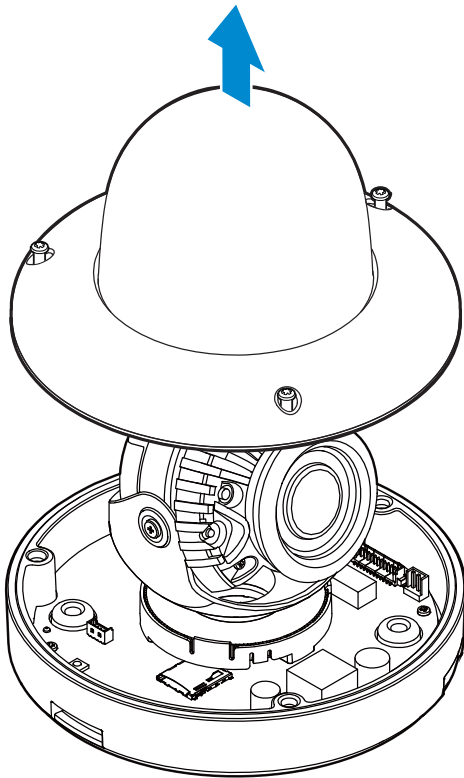

- 1 Detach the dome cover by torx wrench provided from bottom case before installation the camera.

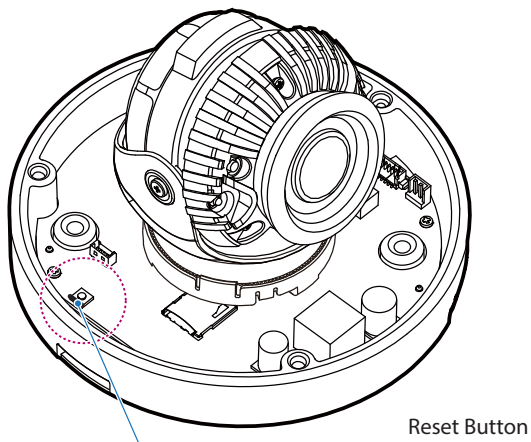

⊠ **Reset to the Factory Default**

Press the reset button for 5 seconds to return the setup to the factory default.

⊠ **Warning:**

If you press the 'Reset' button, you will lose all setting data. If needed, please, make a note for further installation.

Installation - Installation

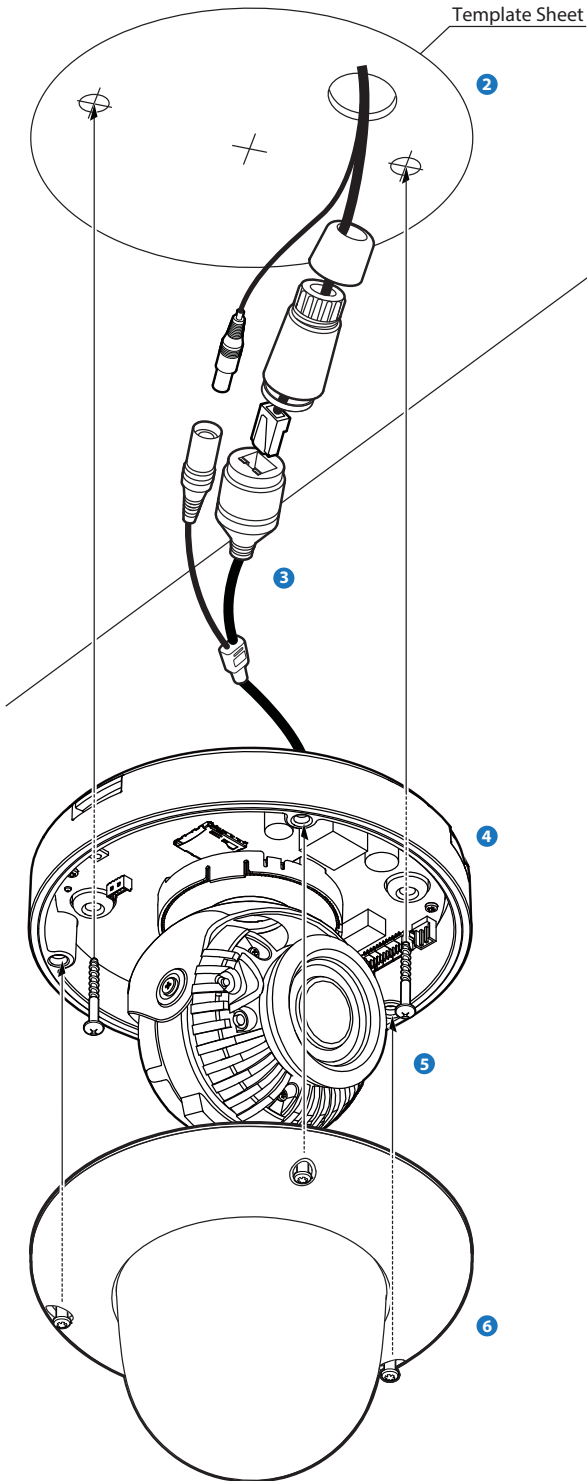

- 1 Disassemble the camera. See the section 'Installation - Disassemble the camera' for details.
- 2 Using the template sheet, make the cabling hole on the wall/ceiling.
- 3 Connect the network cable and power cable respectively. See the section 'Installation - Cabling' for details.

⊠ Put the Lan cable into (a), then (b) will be assembled to (a) tightly. As a final step, (c) need to be assembled to (b) without making any space.

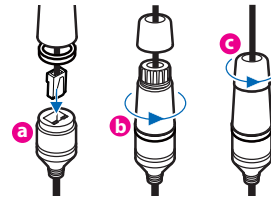

- 4 Once removing the rubber stopper, fix the bottom case on the ceiling.
- 5 To achieve desired view direction and orientation, rotate 3-axis gimbal. To fix the setting, tighten the tilt stopper screw.

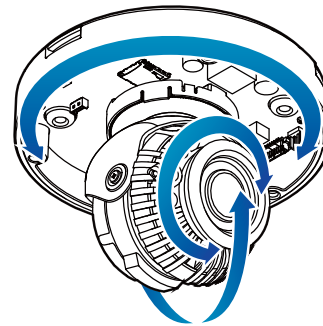

- 6 Attach the dome cover to the bottom case.

⊠ **Warning:**

DO NOT TOUCH THE SURFACE OF THE BUBBLE.
CleanView™ Hydrophobic Dome Coating Repels.

Installation - Installation Using Mount Plate

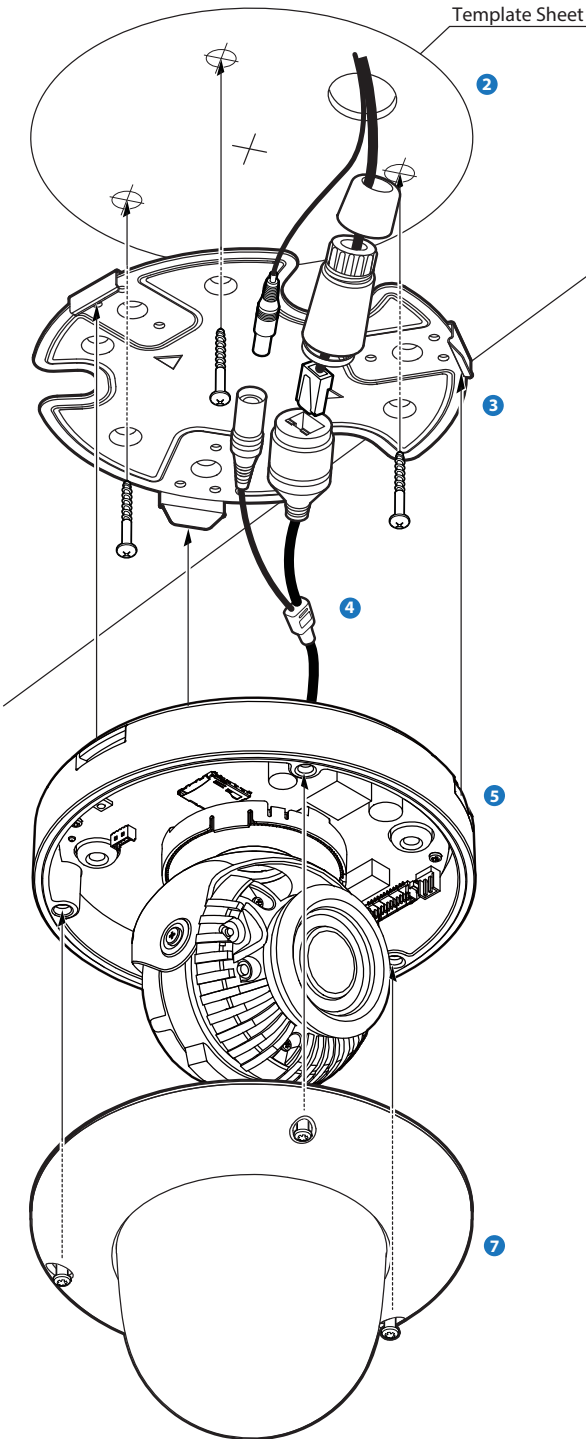

- 1 Disassemble the camera. See the section 'Installation - Disassemble the camera' for details.
- 2 Using the template sheet, make the cabling hole on the wall/ceiling.
- 3 After passing the cables through the hole, fix the mount plate on the template sheet.
- 4 Connect the network cable and power cable respectively. See the section 'Installation - Cabling' for details.
- 5 Fix the bottom case on the mount plate. Press 3 bezels on bottom case of camera till it sounds snap to lock the camera to the mount plate.
- 6 To achieve desired view direction and orientation, rotate 3-axis gimbal. To fix the setting, tighten the tilt stopper screw.

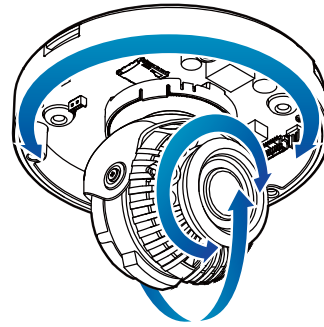

- 7 Attach the dome cover to the bottom case.

⚠ Warning:

DO NOT TOUCH THE SURFACE OF THE BUBBLE.
CleanView™ Hydrophobic Dome Coating Repels.

Installation - Installation Using Mount Bolt & Nut

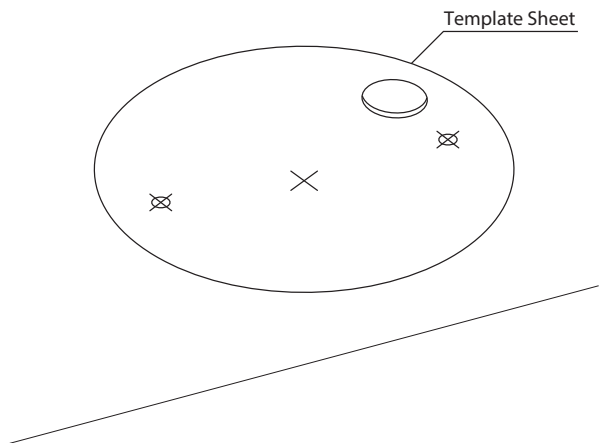

- 1 Disassemble the camera. See the section 'Installation - Disassemble the camera' for details.
- 2 Using the template sheet, make the cabling holes on the ceiling panel.

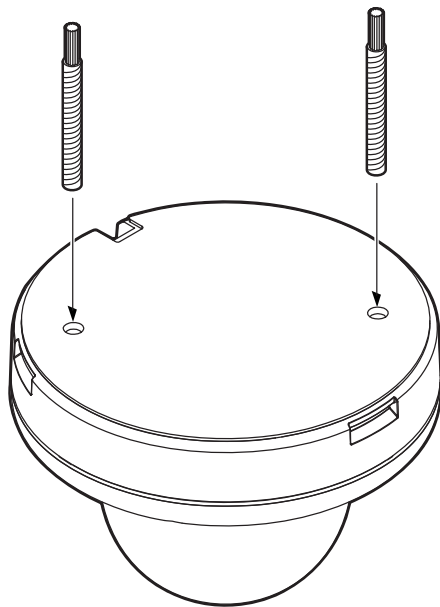

- 3 Insert the 2 mount bolts into bottom case of camera.

Installation - Installation Using Mount Bolt & Nut

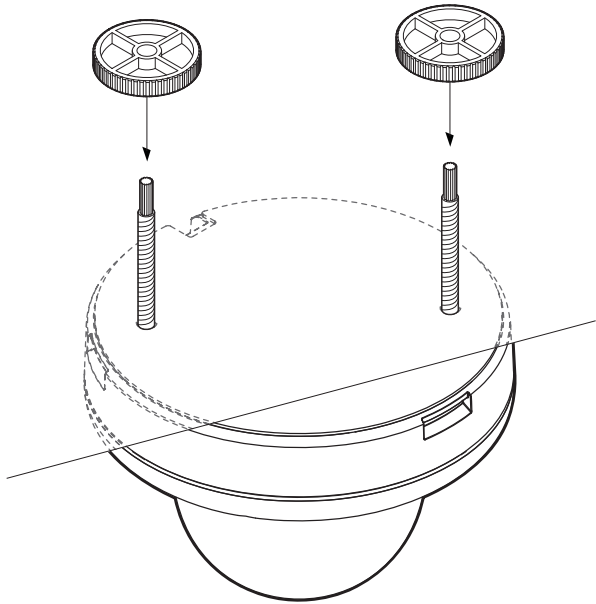

- 4 Insert the mount bolts into template holes after connecting the cable.
- 5 Fix the bottom case by tightening mount nuts to mount bolts on the ceiling panel.

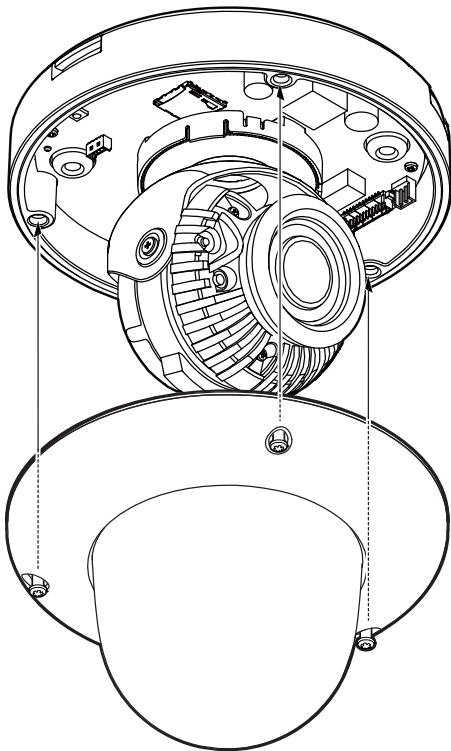
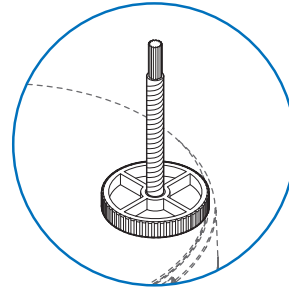

- 6 To achieve desired view direction and orientation, rotate 3-axis gimbal. To fix the setting, tighten the tilt stopper screw.

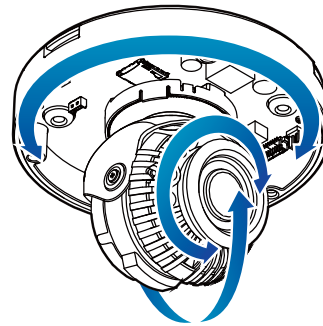

- 7 Attach the dome cover to the bottom case.

Warning:
DO NOT TOUCH THE SURFACE OF THE BUBBLE.
CleanView™ Hydrophobic Dome Coating Repels.

Installation - Cabling

Two Options

Use a PoE-enabled switch to connect data and power through a single cable and begin viewing and recording images instantly. A non-PoE switch will require an adaptor for power transmission.

1. Using a PoE-Enabled Switch

The Camera is PoE-compliant, allowing transmission of power and data via a single Ethernet cable. PoE eliminates the need for the different cables used to power, record, or control the camera. Follow the illustration below to connect the camera to a PoE-enabled switch using an Ethernet cable.

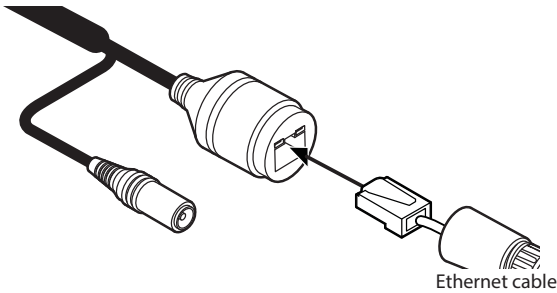

2. Using a Non-PoE Switch

If a PoE-enabled switch is not used, use a power adaptor for power transmission and non-PoE switch for data transmission. Follow the illustrations below to connect the camera without a PoE-enabled Switch.

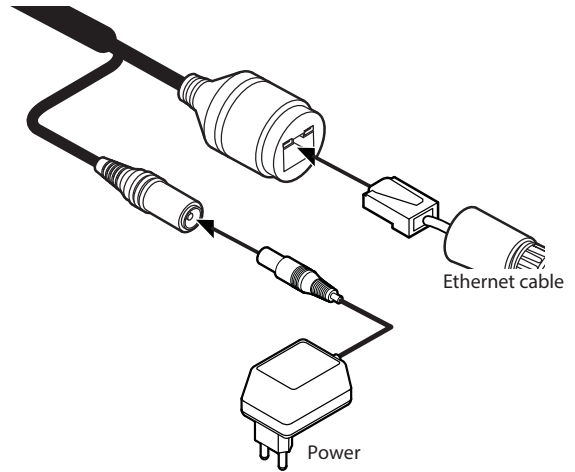

Installation - Inserting/Removing an SD Memory Card

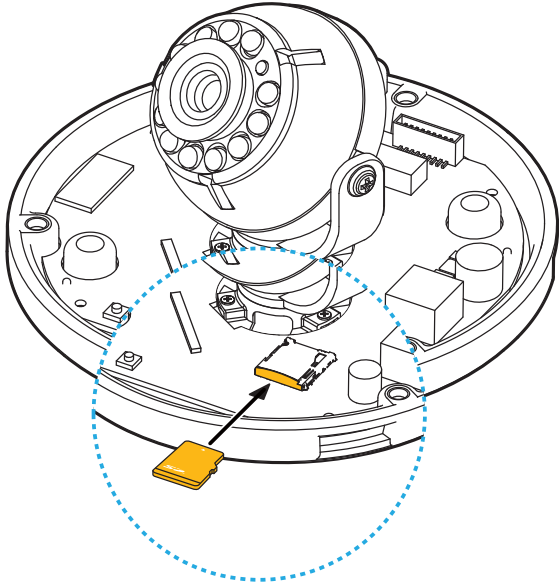

The memory card is an external data storage device that has been developed to offer an entirely new way to record and share video, audio, and text data using digital devices.

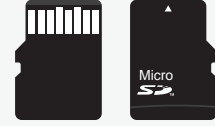

⊠ **Recommended SD Card Specification (Not Included)**

- Type: Micro SD (SD/SDHC/SDXC)
- Manufacturer: Transcend, Kingston, Toshiba, SanDisk
- Capacity: 4GB ~ 128GB
- Class: over UHS-I U3 Class 10

1 Inserting an SD Memory Card

Insert the SD card in the arrow direction.

- ⊠ Don't insert the SD memory card while it's upside down by force. Otherwise, it may damage the SD memory card.

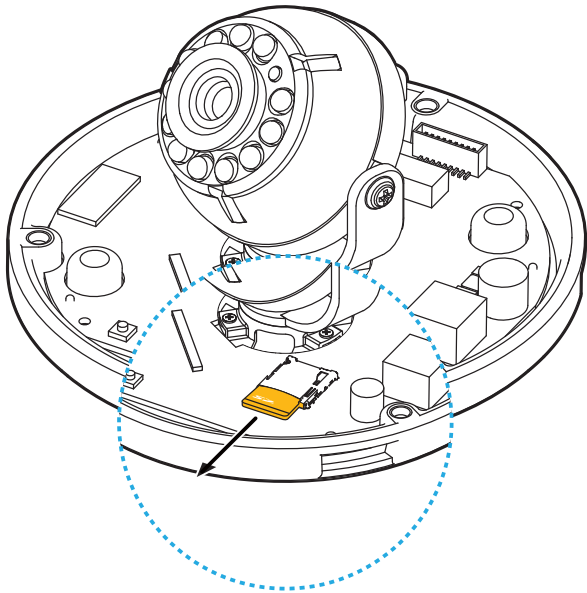

2 Removing an SD Memory Card

Removing an SD Memory Card Gently press down on the exposed end of the memory card as shown in the diagram to eject the memory card from the slot.

- ⊠ Pressing too hard on the SD memory card can cause the card to shoot out uncontrollably from the slot when released.
- ⊠ If you have saved data in the SD memory card, removing the SD memory card prior to setting record to OFF will cause damage to the data stored in the card.

Network Setup - DW IP Finder™

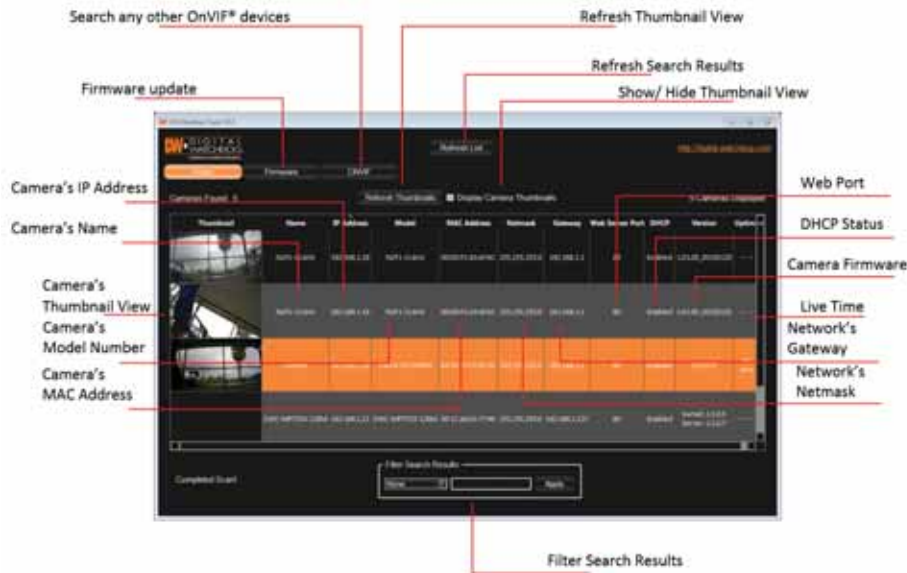

- 1 Go to: <http://www.digital-watchdog.com> and search for 'IP Finder' on the quick search bar at the top of the page.
- 2 The latest IP Finder software will appear in the search results. Click on the link to download the file to your computer.
- 3 The software will scan your network for all supported cameras and display the results in the table. Allow up to 5 seconds for the IP Installer to find the camera on the network.
- 4 you can press the 'Refresh List' to search the network again, or filter the search results by entering a value in the filter box at the bottom of the page.
- 5 Check the box next to 'Display Camera Thumbnail' to view a JPEG image of the camera's view next to the camera name on supported models.

- 1 Select DHCP if the internet service is dynamic IP. This will allow the camera to receive its IP address from the DHCP server.
- 1 Select STATIC to manually enter the camera's IP address, subnet mask, Gateway and DNS information.
- 1 Contact your network administrator for more information.

6 The camera's default network information is:

- 1 Default TCP/IP information
 - IP: 192.168.1.80
 - Subnet Mask: 255.255.255.0
 - Gateway: 192.168.1.1
 - DNS : 168.126.63.1



7 To view the camera's web client, click on 'View Camera Website'.

1 A 'Port Forwarding' has to be set in your network's router for external access to the camera.

8 To save the changes made to the camera's settings, input ID and PW of the camera for authentication.

9 If the camera needs to be rebooted after the settings were changed, press the 'Reboot' button. The camera will power cycle and will appear back in the search results once the reboot is complete.

1 Default ID / PW : admin / admin

10 Click 'Save' to save changed values.

11 To update the camera's firmware from the DW IP Finder™, click on the firmware tab, upload the firmware file and select the cameras to update. You can update multiple cameras at the same time.

Network Setup - Quick Start of Network Connection

Please follow the steps below to complete the initial setup of the network function.

- i** Please do not power on the IP Camera until instructed.
- i** Temporarily disable any proxy servers configured in internet Explorer.
- i** If connecting the IP Camera directly to a modem, power down and reset the modem. Leave the modem powered down until configurations are finalized with the IP Camera and the IP Camera has been correctly connected to the modem.

1. Connect the IP Camera and PC to the configured network.
2. Open the IP Installer on a PC, then search for the IP camera.

- i** If you have a DHCP server, it will automatically set the Camera IP.
- i** If you do not have a DHCP server, Camera IP is set to 192.168.1.80 after one minute. In this case, PC IP must be changed to the IP to be able to access the 192.168.1.80.

3. If multiple numbers of camera are connected it should be distinguished by the mac address of the Camera.
4. Click the Camera IP, and connect to the WEB PAGE.
5. Default ID/Password to access IP Camera are both the word: admin.
6. Familiarize yourself with the Viewer Interface Screen.
7. please install VLC to display live video.
8. The IP setting can be set to 'STATIC' at IP Installer or web viewer followed by Setup -> Network -> Network Settings.
9. If the IP Camera is connected to a network which utilizes a router, you must have Port Forwarding configured on your personal router to forward all ports to the IP address you have assigned the IP Camera.
10. After configuring Port Forwarding on your router (if necessary), you may access your IP Camera on your local network by opening Internet Explorer and specifying the IP address and Web Port that you have assigned to the IP Camera.

- i** Example: <http://192.168.0.200:8888>
- i** If you leave your Web Port set to 80, you don't need to specify the port in the Address Bar to access to your IP Camera.

11. Access your IP Camera via the Internet :

If you use a static IP address assigned by your ISP

- 1) Open Internet Explorer.
 - 2) Type the IP of the IP Camera.
 - 3) If you use a router, type the routers' static IP and the web port number of the IP Camera.
-

If you have a dynamic address provided by your ISP

- 1) Open Internet Explorer and visit the DDNS website.
 - 2) Register the IP Camera.
 - 3) Reboot the IP Camera.
 - 4) Give the DDNS server 10 minutes to locate your IP Camera's IP information.
 - 5) Click the refresh button in the Internet Explore.
 - 6) After your camera is connected, select your camera.
-

Network Setup - DDNS Registration

If you have DYNAMIC IP service from your Internet Service Provider (ISP), you can't tell the current IP address of the IP Camera. To solve this problem, you have to register to our DDNS service.

At first, you have to check if you are using dynamic addressing. If so, register your IP Video Server on our DDNS website before you configure, setup, or install the IP Camera.

Even though your IP is not dynamic, you will get benefit if you register to DDNS. In this case, just remember 'hostname.dyndns.com/gate1' instead of complicated series of numbers like <http://201.23.4.76:8078>.

For more details, contact our Support Center.

☒ To use a public DDNS called 'dyndns' or 'no-ip', refer to the detail information on how to use the service.
(Visit the web site : <http://www.dyndns.com> or <http://www.no-ip.com>)

Network Setup - Guide to Network Environment

Please configure the IP Camera at the installation site. You must determine your network scenario in order to configure the IP Camera with the proper TCP/IP settings. This tutorial will guide you through the process. Before actually configuring the IP Camera, determine settings to be applied. Record those settings to be used to configure your IP Camera for reference.

When configuring your IP Camera, treat the IP Camera as another PC on your network. You will assign it several addresses and other TCP/IP properties to match your current network.

This step-by-step tutorial will teach what IP addresses and network configurations should be assigned based on the network scenario.

5. The following descriptions are several basic network scenarios. Determine which scenario describes your network. If your network does not match one of the scenarios below and you are unsure how to setup your IP Camera, contact your network administrator and then call our Support Center.

i You cannot control the rectangular gray areas and only the ISP has access to the devices.

1. Before you begin, locate any information and settings received from your Internet Service Provider (ISP). You may need to refer to these IP addresses at a later time during the configuration.

Current TCP/IP Settings	
IP Address	
Subnet Mask	
Default Gateway	
Primary DNS Server	
Secondary DNS Server (Option)	

Static Dynamic

i If you were not given any IP addresses or the ISP was responsible for the setup and installation of your Internet connection, go to step 2.

i If you are not using a router on your network, your 'Current TCP/IP Settings' (from the previous section) and 'Assigned IP Addresses from My ISP' will be exactly the same.

2. You must determine whether the IP address is STATIC or DYNAMIC. At this moment, you are only concerned about the ISP. Did they provide you with a STATIC or DYNAMIC address? If you are unsure, contact your ISP.
3. Configure your IP Camera's TCP/IP settings for network connectivity by selecting Setup from the main interface and selecting TCP/IP located on the left of the Setup screen.
4. If prompted for ID and Password, use 'admin' for both entries.

The default web port number is 80. If port 80 is blocked by the ISP, a value between 1025 ~ 60000 should be used. If TCP port 80 is blocked, consult the ISP

Network Setup - Setup Case A, B

Case A: Dynamic IP + Personal Router [Most SOHO]

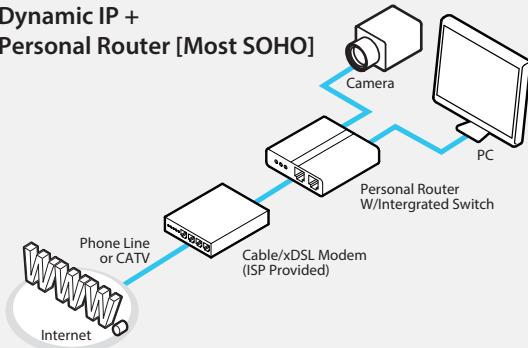

Case B: Static(Fixed) IP + Personal Router [Efficient]

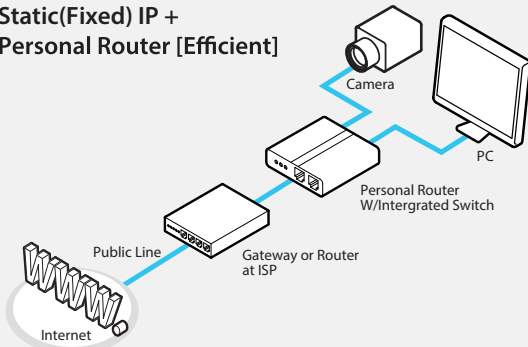

Configure your IP Camera's TCP/IP properties as follows :

- 1. Network Type :** STATIC (even though you have Dynamic IP from your ISP, use STATIC on the IP Camera)
- 2. Internet Address :** A private IP address such as 192.168.0.200 (Example)

- i** You need to assign an IP address to the IP Camera just as you do with PC.
- i** The IP address you assign must be unique to your network and match your network as well. For information on how to choose a unique IP and match your network, read the FAQ.
- i** The IP address you assign must be a private IP. For information on how to choose a private IP please, read the FAQ.

- 3. Subnet Mask :** 255.255.255.0 (Example)

- i** You must use the same subnet mask as the one you noted under 'Current TCP/IP Settings'.

- 4. Default Gateway :** 192.168.0.1 (Example)

- i** This IP address must be the IP address of your router. (private or LAN side)
- i** Use the same Default Gateway you noted under 'Current TCP/IP Settings'.

- 5. Preferred DNS Server :** Use the 1st DNS Server from 'Assigned IP Address from My ISP'.

- i** If you did not receive any IP addresses from your ISP, contact the ISP and acquire the IP address of their DNS server.

- 6. DDNS Server :** Use the DDNS server.

- i** This is the same site you will register later to accommodate dynamic IP from your ISP.

- 7. Web Port :** 8888

- i** Do not use the default port 80 as this number must be changed.
- i** You may select any number between 1025 ~ 60000.

Network Setup - Setup Case C, D

Case C: Static(Fixed) IP [Dedicated line directly to the IP Camera]

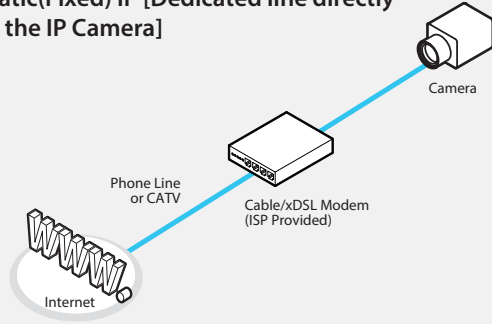

Configure your IP Camera's TCP/IP properties as follows :

1. **Network Type** : STATIC
2. **Internet Address** : A static IP address received from your ISP such as 24.107.88.125 (Example)

i You need to assign an IP address to the IP Camera just as you do with PC.

3. **Subnet Mask** : Subnet mask assigned from your ISP such as 255.255.255.240 (Example)
4. **Default Gateway** : 24.107.88.113 (Example)

i Use the assigned default gateway from your ISP

5. **Preferred DNS Server** : Use the 1st DNS Server from 'Assigned IP Address from My ISP'

i If you have not received any IP addresses from your ISP, contact them to acquire the IP address of their DNS server.

6. **DDNS Server** : Use the DDNS server

i This is the same site you will register later to utilize our DDNS service.

7. **Web Port** : 80

i You may select any number between 1025 ~ 60000.

Case D: Dynamic IP + DSL/Cable Modem [Connected directly to the IP Camera]

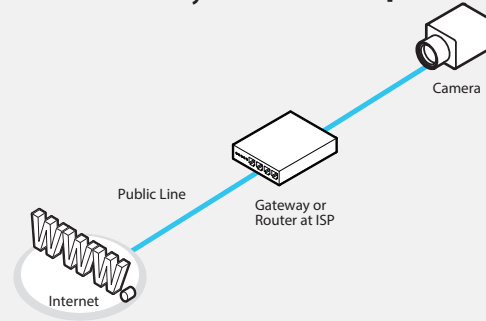

i To connect the IP Camera directly to a modem, power down and reset the modem. Leave the modem powered down until configurations are finalized with the IP Camera and the IP Camera has been connected correctly to the modem. Then power on the modem, followed by the IP Camera.

Configure your IP Camera's TCP/IP properties as follows :

1. **Network Type** : DYNAMIC
2. **DDNS Server** : Use the DDNS server

i This is the same site you will register later to accommodate dynamic IP from your ISP.

3. **Web Port** : 80

i You may select any number between 1025 ~ 60000.

Network Setup - Port Forwarding

After entering the correct TCP/IP settings, you are ready for 'Port Forwarding'(Cases A, B).

1. Please record the TCP/IP settings of your IP Camera for future reference. You may need this information to access your IP Camera and to configure 'Port Forwarding'.

IP Camera TCP/IP Settings	
IP Address	
Subnet Mask	
Default Gateway	
Preferred DNS Server	
DDNS Server	
Web Port	

2. After clicking 'Apply', the system will prompt for a reboot. Please allow the system 50 seconds to reboot and accept the changes. After 50 seconds, close the configuration screen. The view will display 'Trying to Reconnect'. If the ACTIVE light on the IP Camera has gone off and is now back on again flashing, the IP Camera has rebooted. After the system reboots completely, remove the power supply from the unit and close Internet Explorer.
3. Return your PC/Laptop TCP/IP properties to their original settings.
4. Before installing the IP Camera, you must use 'Port Forwarding' on your personal router (Cases A, B).

You will need to forward 1 ports:

- Web Port

All the ports will be forwarded to the IP address you assigned to the IP Camera.

In the example above, you would forward:

- 8888 → 192.168.0.200

i For information on how to use 'Port Forwarding', please read Appendix C.

Network Setup - Starting IP Camera

After forwarding correctly the Web Port, through your router (if applicable), install the IP Camera in a proper location.

1. Locate the serial number located on the label attached to the bottom of the IP Camera, you will need this for DDNS registration.
2. Connect the IP Camera to your router or cable/DSL modem (per your network scenario) via a Cat5/5e UTP Ethernet network cable.
3. Supply power to the IP Camera.
4. After 1 minute, verify the IP Camera indicators:
 - LINK : Flickering/Solid
5. After configuring Port Forwarding on your computer (if necessary), access your IP Camera on your local network by opening Internet Explorer and specifying the IP address and Web Port assigned to the IP Camera.

- ❗ Examples: <http://192.168.0.200:8888> or <http://24.106.88.123>
- ❗ If you left your Web Port set to 80, do not need to specify the port in the Address Bar to access the IP Camera.

6. Access your IP Camera via the Internet :

If you use Case B, C

- 1) Open Internet Explorer.
- 2) Type the IP of the IP Camera.

If you use Case A, D

- 1) Open Internet Explorer.
 - 2) Visit the DDNS website.
 - 3) Register the IP Camera.
 - 4) Give the DDNS server 10 minutes (MAX) to locate your IP Camera's IP information. You may reboot the server to send an immediate request to our DDNS server.
 - 5) After your camera is connected, select your camera.
-

- ❗ The difference between B and C is that B needs to set the port forwarding.
- ❗ Since the type of DDNS differs from the service type, refer to the related service site.

Web Viewer Screen - Basic Screen

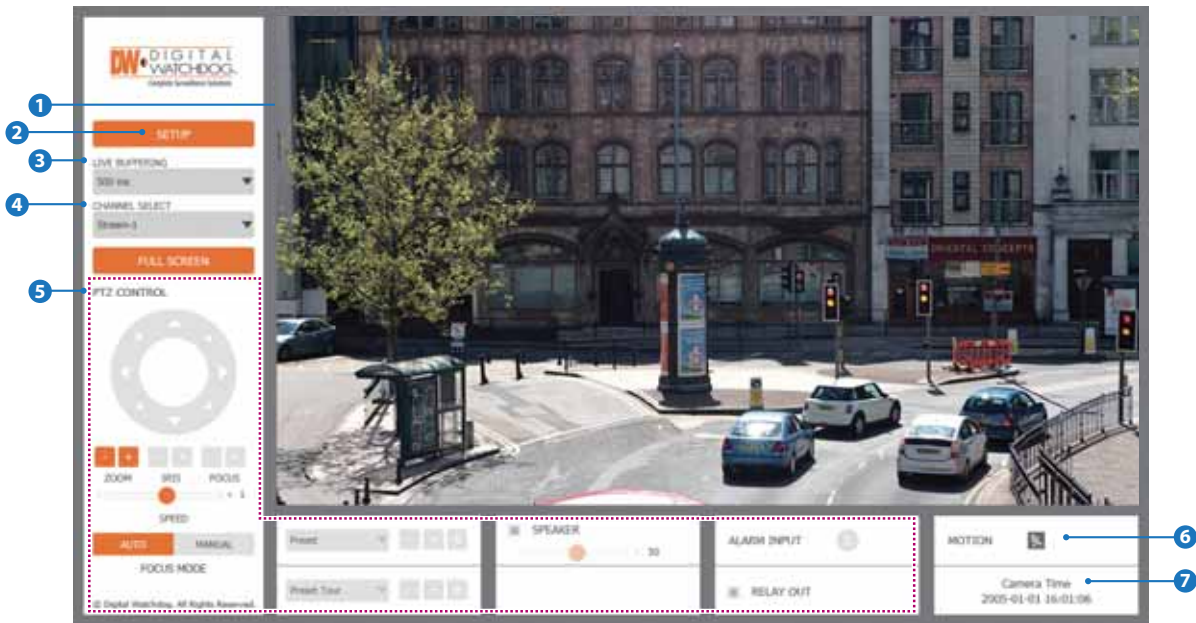

⊗ Web viewer is optimized with explorer10 or above version and Firefox.

⊗ If VLC is not installed or VLC plugin is not supported (Chrome), Live buffering and Channel select menu on 3, 4 will be changed to Live Viewer menu, and then if HTML5(MJPEG) is selected on Live Viewer menu, then you can check the video.

- 1 Live video display. This is the region for live video stream from the camera.
- 2 Setup popup button. Click it to open the Setup page to setup details of IP camera like Video, Network, Events, System and etc. See the section 'Setup'.
- 3 When the image goes unsmoothly because of bad network connection, it stored image during setup time and shows the image on the live view screen.
 - ⊗ User will see the delayed images as much as setup time.
- 4 Channel Select button. Select a stream produced from the camera between Stream 1 ~ 3 to display it in the live view screen.
 - ⊗ Refer the 'Setup > Video & Audio > Video' to setup the Video Stream.

5 Below "Menu" is supported in accordance with models.

PTZ Control

This camera model supports the zoom and focus.

Preset

Does not support.

Speaker Control

Does not support.

Alarm Input

Does not support.

Relay Out

Does not support.

6 Motion

It shows the Motion event status.

⊗ Event Alert Icon (🚨) appears if 'Motion Detection' is activated.

7 Camera Time

Display the camera time.

Setup - Video Configuration

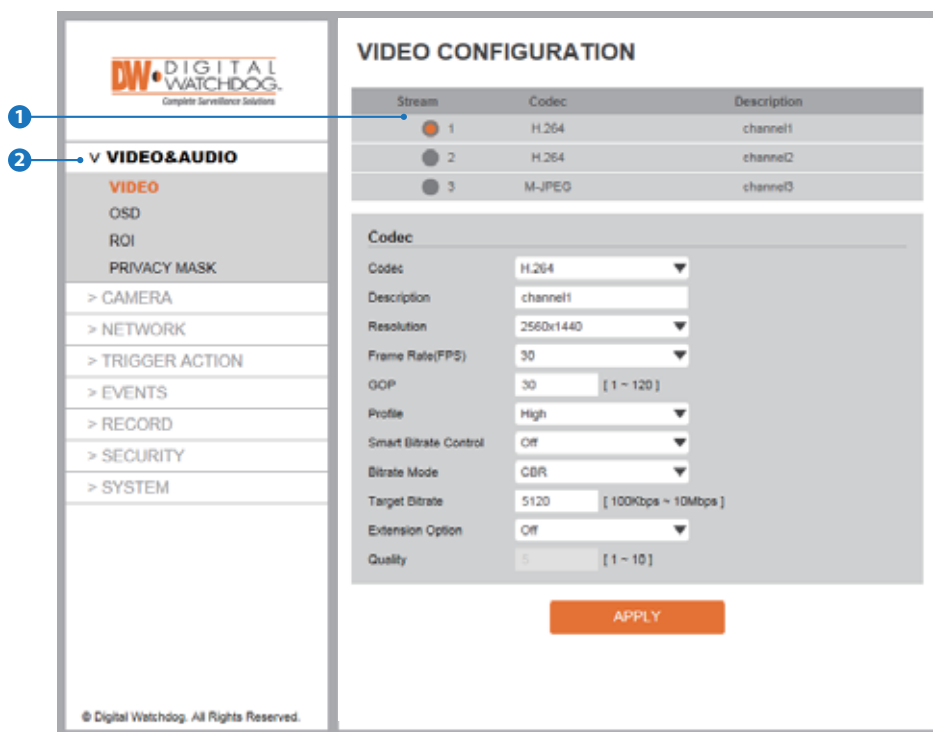

1 Detail Page

When you select an item from the menu, you can set the details for the selected item.

2 Setup Constitution

Video&Audio

[VIDEO, OSD, ROI, PRIVACY MASK]

Camera

[IMAGE ADJUSTMENT, EXPOSURE, DAY&NIGHT, BACKLIGHT, WHITE BALANCE, IMAGE, VIDEO]

Network

[STATUS, NETWORK SETTING, AUTO IP, ONVIF, UPNP, DDNS, FTP, SMTP, SNMP, RTSP INFORMATION]

Trigger Action

[ACTION RULES, IMAGE TRANSFER]

Events

[EVENT RULES, MOTION, TEMPERATURE]

Record

[MANAGEMENT, RECORD LIST, STORAGE]

Security

[IP ADDRESS FILTER, RTSP AUTHENTICATION, IEEE 802.1x, HTTPS, CERTIFICATES, SERVICE]

System

[INFORMATION, FIRMWARE UPDATE, DATE&TIME, DST, USER MANAGEMENT, LOG, FACTORY RESET, RESTART]

Setup - Video Configuration

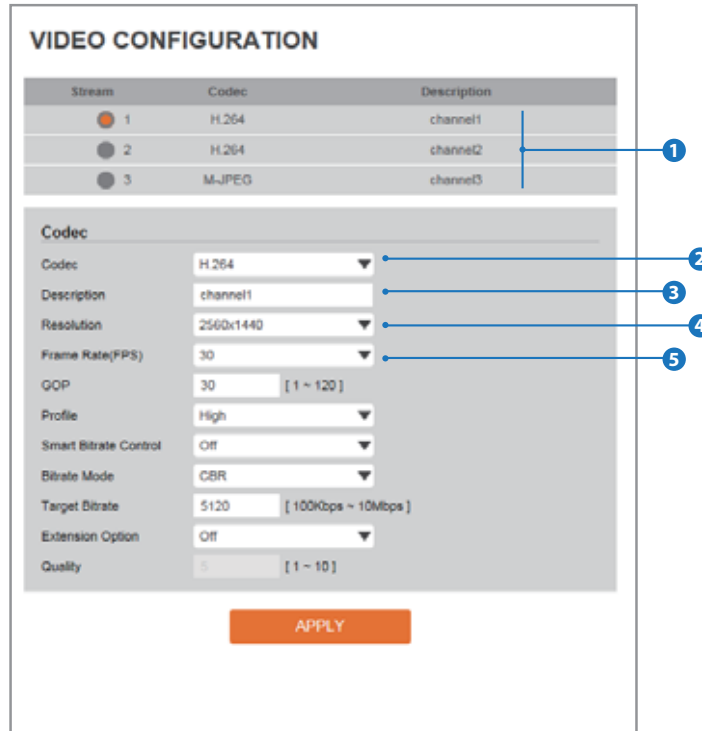

1 Live Video Channel Setup

The video can be configured to variety settings with a combination of codec and resolution. The camera performance has to be considered when setting multiple channels. This effects on the performance of the camera.

2 Codec

Choose the video codec. According to the selected codec, the subcategories can be changed automatically.

3 Description

Input the additional description about the selected channel. Max. 30 alphabets are allowed(Including space). For the description, English Alphabets, numbers and special characters (- _ @ .) can be used.

4 Resolution

Select the video resolution.

Available resolution can be depends on the codec setup between the channels.

	NTSC	PAL
4M	2560 x 1440	2560 x 1440
3M	2304 x 1296	2304 x 1296
1080p/i	1920 x 1080	1920 x 1080
720p/i	1280 x 720	1280 x 720
SVGA	800 x 600	800 x 600
VGA	640 x 480	640 x 480
4CIF	704 x 576 704 x 480	704 x 576 704 x 480
CIF	352 x 288 352 x 240	352 x 288 352 x 240

<Resolution of Video Format>

5 Frame Rate

Select the maximum Frame Rate.

Available Frame Rate can be different although same codecs were set up.

Setup - Video Configuration

Stream	Codec	Description
1	H.264	channel1
2	H.264	channel2
3	M-JPEG	channel3

Codec

Codec: H.264

Description: channel1

Resolution: 2560x1440

Frame Rate(FPS): 30

GOP: 30 [1 ~ 120]

Profile: High

Smart Bitrate Control: Off

Bitrate Mode: CBR

Target Bitrate: 5120 [100Kbps ~ 10Mbps]

Extension Option: Off

Quality: 5 [1 ~ 10]

APPLY

6 GOP(Group of Pictures) Size

Set up the number of frames (P-frame) which contain only changed information based on basic frame (I-frame). Regarding videos with lots of movement, if you set GOP size bigger, only the number of P-frames is bigger. As a result, video resolution will be low but 'File size' and 'Bit-rate can be decreased.

⊠ GOP(Group of Pictures) Size is..

I-frame and P-frame can be created for MPEG4 and H.264 video compression. I-frame(=key-frame) means the whole image data for one specific scene of video. P-frame is image data which has been changed information compared to I-frame GOP is made up of one I-frame and corresponding several P-frames. To improve video quality, set the number of P-frames smaller and to decrease image size, set the number of P-frames bigger.

7 Profile

The profile defines the subset of bit stream features in an H.264 stream, including color reproduction and additional video compression.

Baseline

A simple profile with a low compression ratio.
The Baseline profile supports I-frames and P-frames.

Main

An intermediate profile with a medium compression ratio.
The main profile supports I-frames, P-frames, and B-frames.

High

A complex profile with a high compression ratio.
The high profile supports I-frames, P-frames, and B-frames.

8 Smart Bitrate Control

Off

You can not use the Smart Bitrate Control function.

CVBR (Framerate priority)

This Mode is for cameras which do not want absolute any frame drop, but still want to get lower bitrate. It has limitation when the Target bitrate is set to be very low, but actual motion is big or scene is very noisy.

CVBR (Quality priority)

When the Target bitrate is set to very low, and motion is big, then LBR will try to drop frames, and make the final fps to be lower, so that it can save its and make the output frames to have better quality.

CBR

This Mode is a CBR alike mode which is close to traditional security IPCAM, and it's not designed for LBR, It's provided as an option in LBR library just to help comparison.

Setup - Video Configuration

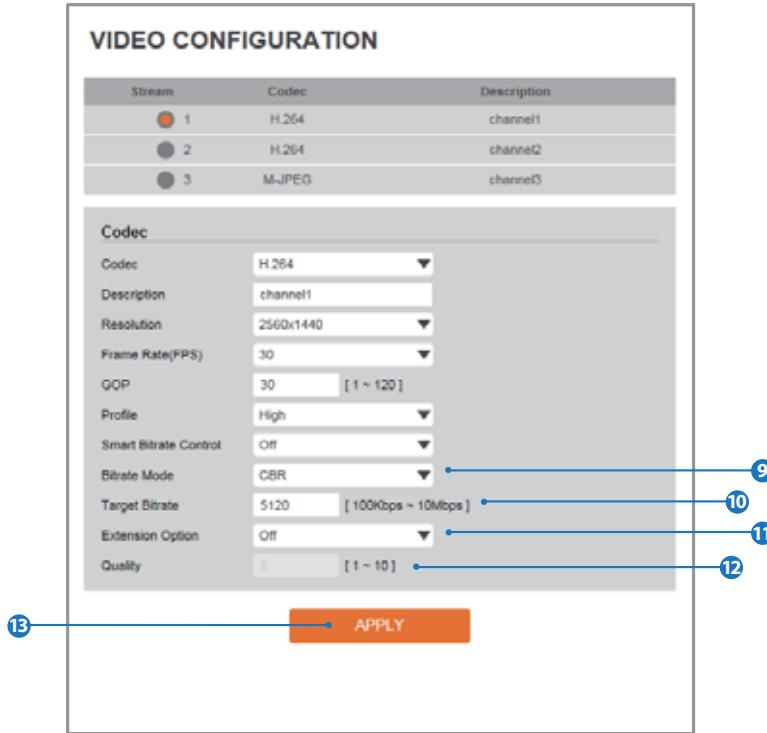

9 Bitrate Mode

Select the bit rate control scheme of video compression from CBR (Constant Bit Rate) or VBR (Variable Bit Rate).

CBR

To guarantee the designated constant bit rate, the quality of video are controlled in this mode. Therefore, the quality of video is likely to be varying when network traffic is changing.

VBR

To guarantee the designated quality, the bit rate of video stream is changed in this mode. Therefore, the frame rate of video is likely to be varying when network traffic is changing.

⚠ This category won't be appear if you select the codec.

10 Target Bitrate

If Bitrate Control is set to be CBR, you can set the Target Bitrate.

11 Extension Option

Off

You can not use the Extension Option.

SVC-T On

The H.264 SVC (Scalable Video Coding) is a video compression algorithm that enables effective and efficient transmission of video files over low bandwidth networks.

12 Quality

For VBR control mode, The Target Quality of video can be setup.

13 Click 'Apply' to make above setting effective.

Setup - OSD Configuration

ON SCREEN DISPLAY(OSD) CONFIGURATION

Date & Time

Off On

Position X [0 - 100]

Position Y [0 - 100]

User Text

Off On

Position X [0 - 100]

Position Y [0 - 100]

Text

APPLY

- 1 Date/Time**
Display the current time.
- 2 User Text**
Output the TEXT entered by the user.
Support a maximum of 30 characters.
- 3 Click 'Apply'** to make above setting effective.

Setup - Region of Interest Configuration

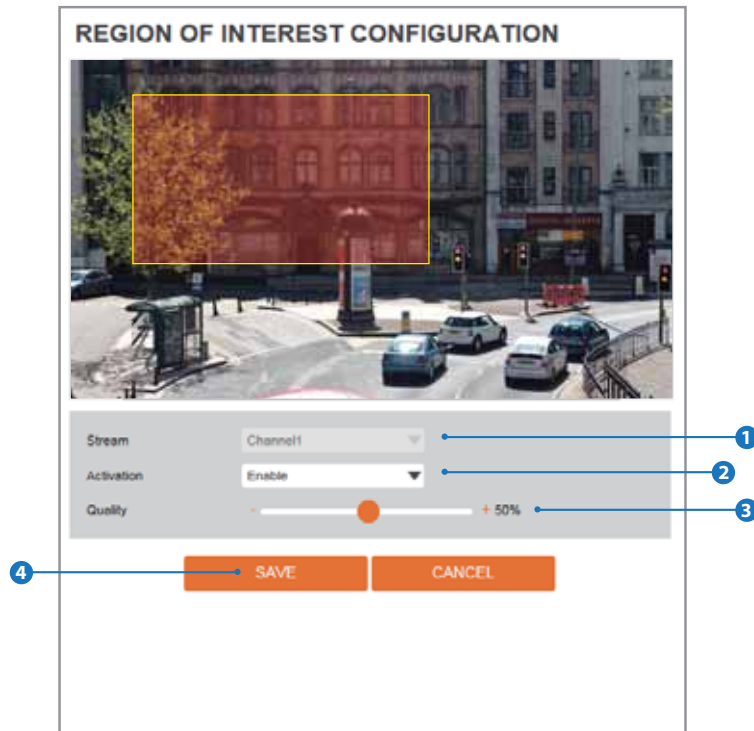

Region of interest function gives much more efficiency picture quality for indicated area to improve picture qualities of movement scene at the same bandwidth.

- 1 **Stream**
Select the Stream.
⊗ Currently it supports only Channel1.
- 2 **Activation**
The Region of interest can be enable or disable.
- 3 **Quality**
Set the quality of the set area.
- 4 Click 'Save' to save the current settings.
⊗ Click 'Cancel' to return to the previous setting.

Setup - Privacy Mask Configuration

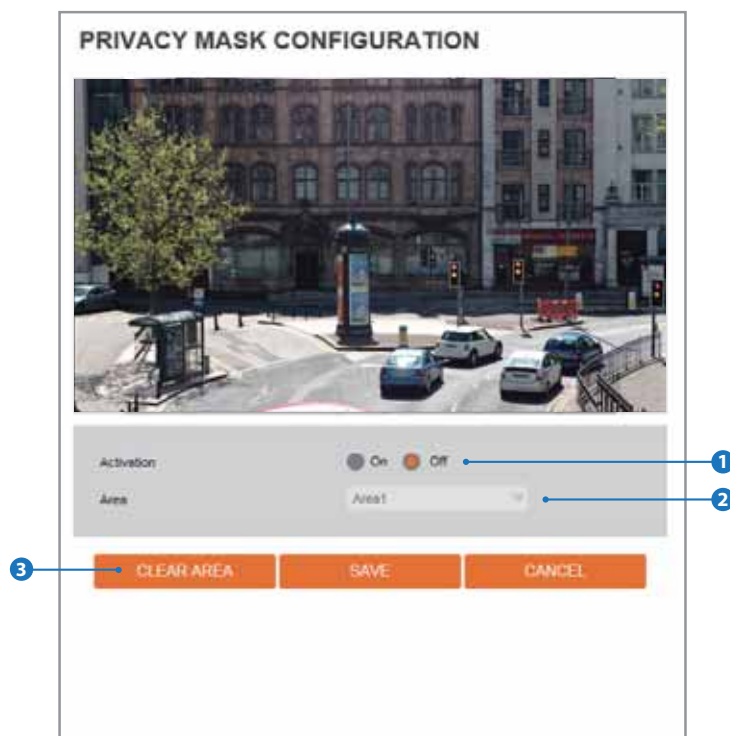

Use this function to mask areas that you want to hide on screen to protect privacy.

- 1 **Activation**
The Privacy mask function can be enable or disable.
- 2 **Area**
Select the Area1 ~ Area4 and Set the privacy area.
- 3 Click 'Save' to save the current settings.
 - ⊠ Click 'Cancel' to return to the previous setting.
 - ⊠ Click 'Clear Area' to delete the selected Area1~Area4.

Setup - Camera Image Adjustment

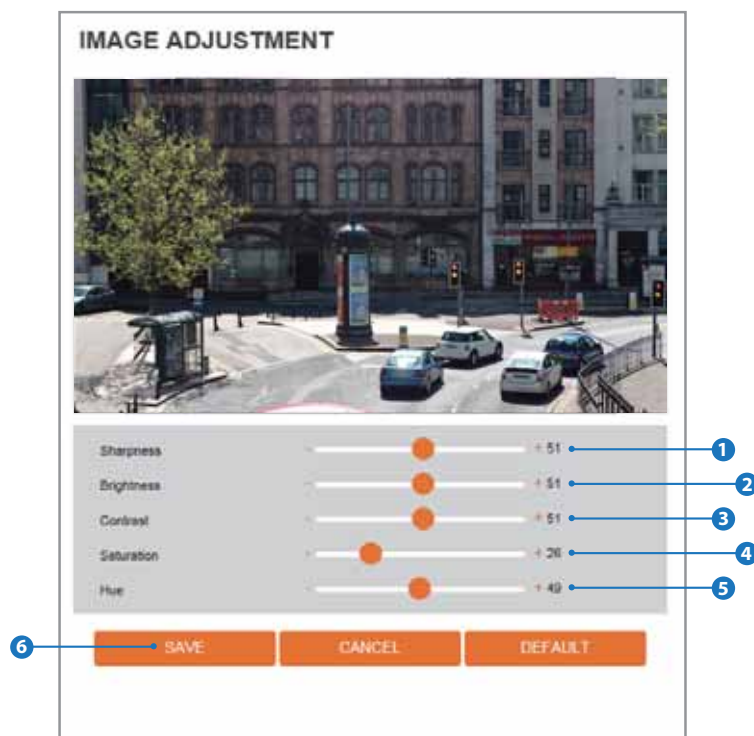

1 Sharpness

Using this control, sharpness of image can be adjusted to meet your preference.

2 Brightness

Using this control, brightness of image can be adjusted to meet your preference.

3 Contrast

Using this control, contrast of image can be adjusted to meet your preference.

4 Saturation

Using this control, Saturation of image can be adjusted to meet your preference.

5 Hue

Using this control, Hue of image can be adjusted to meet your preference.

6 Click 'Save' to save the current settings.

- Click 'Cancel' to return to the previous setting.
- Click 'Default' to settings to the factory defaults.

Setup - Camera Exposure Settings

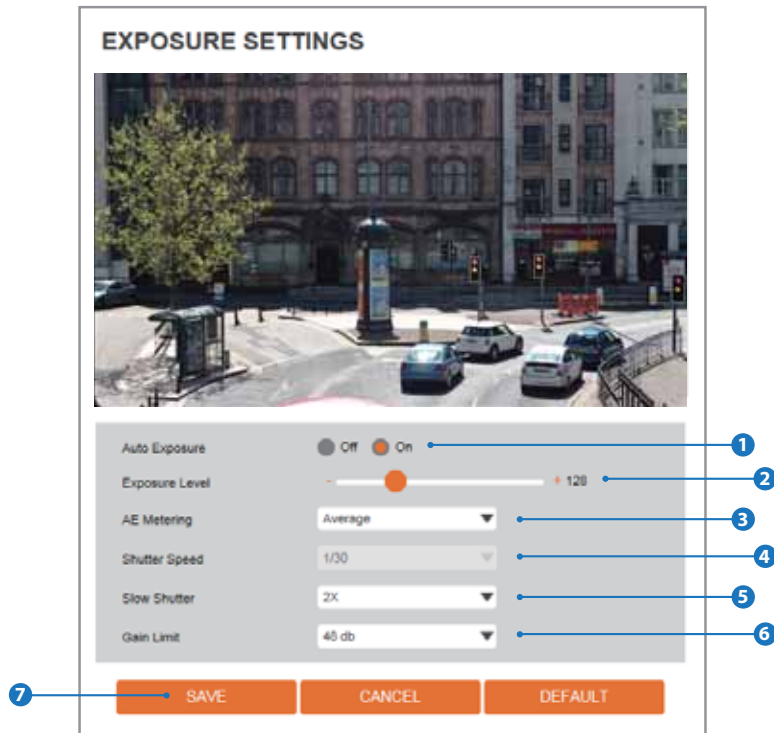

1 Auto Exposure

Automatic exposure(AE) automatically sets the aperture or shutter speed, based on the external lighting conditions for the photo.

2 Exposure Level

If this value is increases, the image becomes brighter.

3 AE metering

AE metering mode refers to the way in which a camera determines the exposure.

4 Shutter Speed

If this speed is faster, the moving object can be photographed without the ghost effect. However, picture can be dark if there is no sufficient lighting.

5 Slow Shutter Level

Slow shutter Level lets you adjust the amount of light striking the sensor, and essentially determines when the video sensor sends out its batch of data for processing.

6 Gain Limit

The smaller number makes the daker image.

7 Click 'Save' to save the current settings.

⊠ Click 'Cancel' to return to the previous setting.

⊠ Click 'Default' to settings to the factory defaults.

Setup - Camera Day & Night Settings

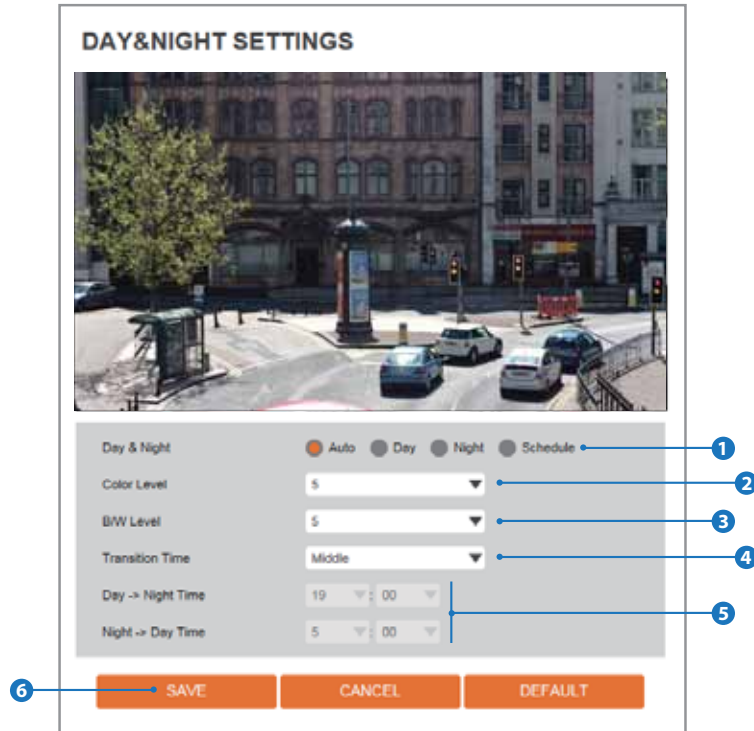

1 Day & Night

Auto: In this mode, the IR cut filter is removed automatically depending on the light condition around.

Day: In this mode, the IR cut filter is applied to the image sensor all the time. Thus, the sensitivity will be reduced in the dark light condition but the better color reproduction performance are obtained.

Night: In this mode, the IR cut filter on the image sensor is removed all the time. The sensitivity will be enhanced in the dark light condition but the image is black and white.

Schedule: In this mode, Day / Night mode is converted accordance with the scheduled time.

2 Color Level

It is a level to change Night mode into Day mode when Day & Night mode is Auto.

3 B / W Level

It is a level to change Day mode into Night mode when Day & Night mode is Auto.

4 Transition Time

If it is set to Auto, to determine the rate at which Day / Night is converted.

5

If it is set to schedule mode, Set the time that Day / Night is converted.

6

Click 'Save' to save the current settings.

- ⊠ Click 'Cancel' to return to the previous setting.
- ⊠ Click 'Default' to settings to the factory defaults.

Setup - Camera Backlight Settings

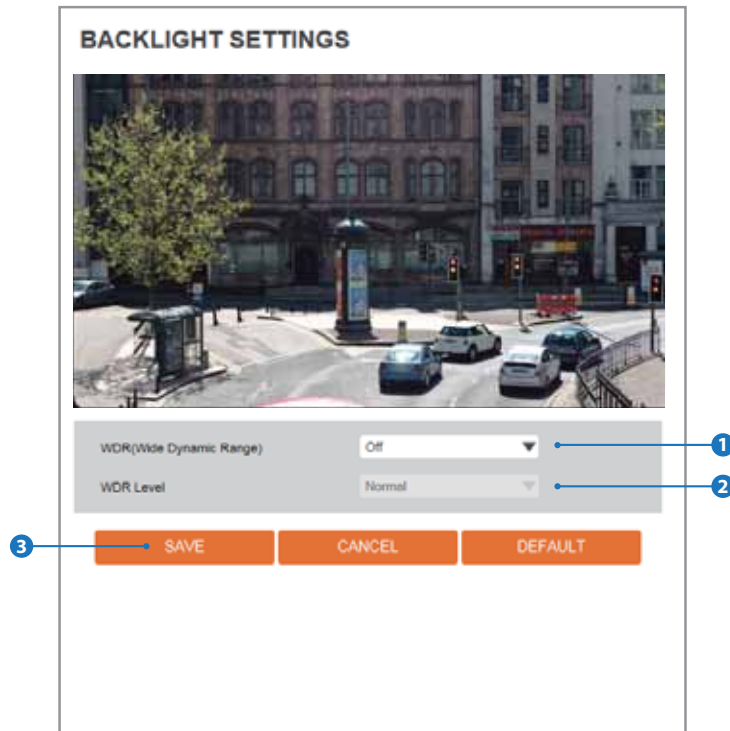

This is a feature used for problematic light conditions where the contrast from light to dark areas is very high.

- 1 **WDR (Wide Dynamic Range)**
The WDR function can be enable or disable.
- 2 **WDR Level**
Select the WDR level depending on the difference in brightness between the darkest and lightest part of an image.
- 3 Click 'Save' to save the current settings.
 - ⊠ Click 'Cancel' to return to the previous setting.
 - ⊠ Click 'Default' to settings to the factory defaults.

Setup - Camera White Balance

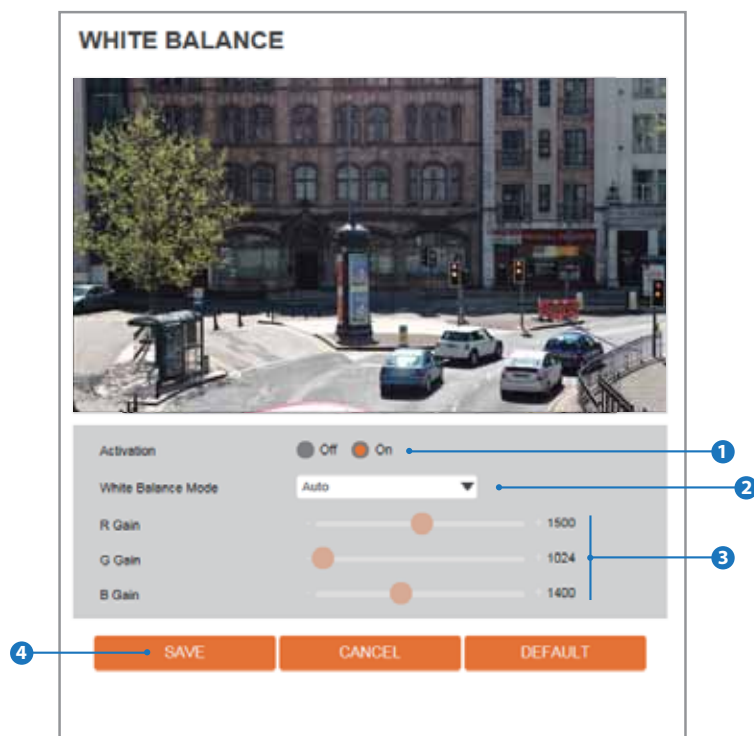

1 Activation

White Balance can be enable or disable.

2 White Balance Mode

Select White Balance depending on the lighting conditions.

3 RGB Gain

The R/G/B gain can be set only when the White Balance Mode is set to Manual.

4 Click 'Save' to save the current settings.

⊠ Click 'Cancel' to return to the previous setting.

⊠ Click 'Default' to settings to the factory defaults.

Setup - Camera Image Enhancement

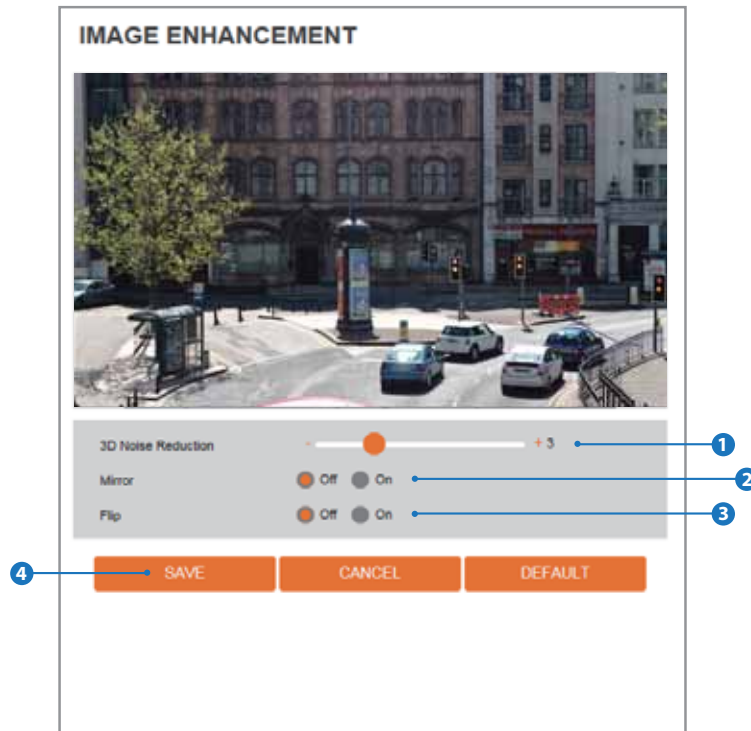

- 1 3D Noise Reduction**
3DNR function enables to suppress noise and retain good video quality in low light conditions.
- 2 Mirror**
Reverse the video from side to side.
- 3 Flip**
Reverse the video from up to down.
- 4** Click 'Save' to save the current settings.
 - ⊠ Click 'Cancel' to return to the previous setting.
 - ⊠ Click 'Default' to settings to the factory defaults.

Setup - Video Enhancement

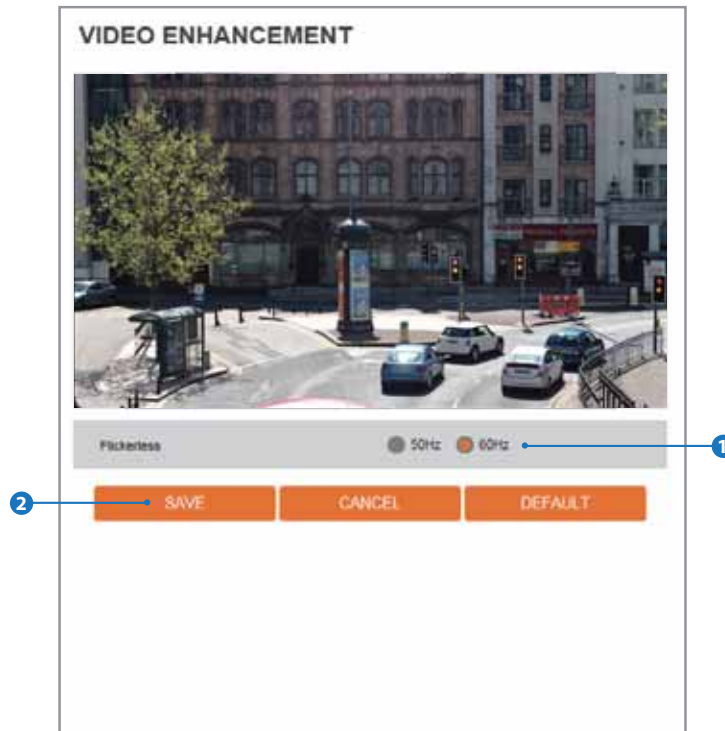

- 1 Flicker**
This function Enable to enhance the flicker situation.
- 2** Click 'Save' to save the current settings.
 - ✘ Click 'Cancel' to return to the previous setting.
 - ✘ Click 'Default' to settings to the factory defaults.

Setup - Network Status

NETWORK STATUS	
MAC Address	64:78:57:CE:00:45
IP Address	192.168.1.33
Subnet Mask	255.255.0.0
Default Gateway	192.168.1.1
Preferred DNS Server	203.248.252.2
Alternate DNS Server	164.124.101.2
HTTP Port	80
RTSP Port	554

This menu will show you all the information of Network setting in the camera. However, you cannot change those here.

Setup - Network Settings

NETWORK SETTINGS

Network Type
 Static Dynamic

IP setup

IP Address: 192.168.1.113
Subnet Mask: 255.255.255.0
Default Gateway: 192.168.1.1
Preferred DNS Server: 168.126.63.1
Alternate DNS Server: 168.126.63.2

Port Setup

HTTP Port: 80 [Default: 80, 1025 - 60000]
HTTPS Port: 443 [Default: 443, 1025 - 60000]
RTSP Port: 554 [Default: 554, 1025 - 60000]

APPLY

1 Network Type

Define network IP address type from the Static Mode for the fixed IP or the Dynamic Mode by the dynamic IP address. If you select the Static Mode, you must fill out IP Address, Subnet Mask, Gateway, DNS Server and all ports. If you select the Dynamic Mode, the IP address will be allocated automatically by DHCP equipment. If you click the Apply button to update changes, the system will be re-booted. In this case, you have to reconnect the camera using new IP address.

2 IP Address

Define the IP address. The address is consisted of four numbers separated by dots and the range of each number is from 0 to 255.

3 Subnet Mask

Define the Subnet Mask. Format is same as the IP address.

4 Default Gateway

Default the Gateway IP Address. Format is same as the IP address.

5 Preferred DNS Server

Define the DNS server IP address. Format is same as the IP address.

6 Alternate DNS Server

Define the Secondary DNS server IP address. Format is same as the IP address.

7 HTTP Port

The HTTP port can be set to 80 which default or in between 1025 to 60000.

8 HTTPS Port

The HTTPS port can be set to 443 which default or in between 1025 to 60000.

9 RTSP Port

The RTSP port can be set to 554 which default or in between 1025 to 60000.

10 Click 'Apply' to make above setting effective.

⚠ If the network type is dynamic, the IP address is changed in below cases. Therefore, the IP address needs to be searched again, and the camera needs to be reconnected in these cases.

- When the camera power is on / off.
- After Firmware update, Default set and reboot.

Setup - Auto IP Settings

AUTO IP SETTINGS

General Setting

Off On

UNIQUE ID	a632e4fb-0821-4c35-b232-66c415d674a5
AUTO IP ADDRESS	169.254.169.3

APPLY

- 1 General Setting**
Auto IP Settings function can be enable or disable.
- 2 Auto IP Settings Information**
It displays the unique id or Auto IP address.
- 3 Click 'Apply' to make above setting effective.**

Setup - ONVIF Settings

The screenshot shows the 'ONVIF SETTINGS' interface. It contains two sections: 'Authentication' and 'Discovery mode'. The 'Authentication' section has three radio button options: 'None', 'WS-Usertoken', and 'WS-Usertoken + Digest'. The 'Discovery mode' section has two radio button options: 'Discoverable' and 'Nondiscoverable'. Below these sections is an orange 'APPLY' button. Three blue callout boxes with numbers 1, 2, and 3 are present. Callout 1 points to the 'Authentication' section, callout 2 points to the 'Discovery mode' section, and callout 3 points to the 'APPLY' button.

1 Authentication

None: Allows to access without ONVIF authentication.

WS - Usertoken: Allows to access with WS-User Token of ONVIF authentication.

WS - Usertoken + Digest: Allows to access with WS-User Token and Digest of ONVIF authentication.

2 Discovery Mode

The discovery function can be enable or disable.

3 Click 'Apply' to make above setting effective.

Setup - UPNP Settings

The screenshot shows the 'UPNP SETTINGS' interface. It is divided into two main sections: 'General Setting' and 'Device Information'. The 'General Setting' section contains two radio buttons, 'Off' and 'On', with the 'On' button selected. The 'Device Information' section contains a text input field labeled 'FriendlyName' with the value 'UPNP_SETTING'. Below these sections is an orange 'APPLY' button. Three blue callout lines with numbered circles (1, 2, and 3) point to the 'General Setting' section, the 'Device Information' section, and the 'APPLY' button, respectively.

- 1 General Setting**
UPNP function can be enable or disable.
- 2 Friendly Name**
Define the friendly name.
- 3** Click 'Apply' to make above setting effective.

Setup - DDNS Settings

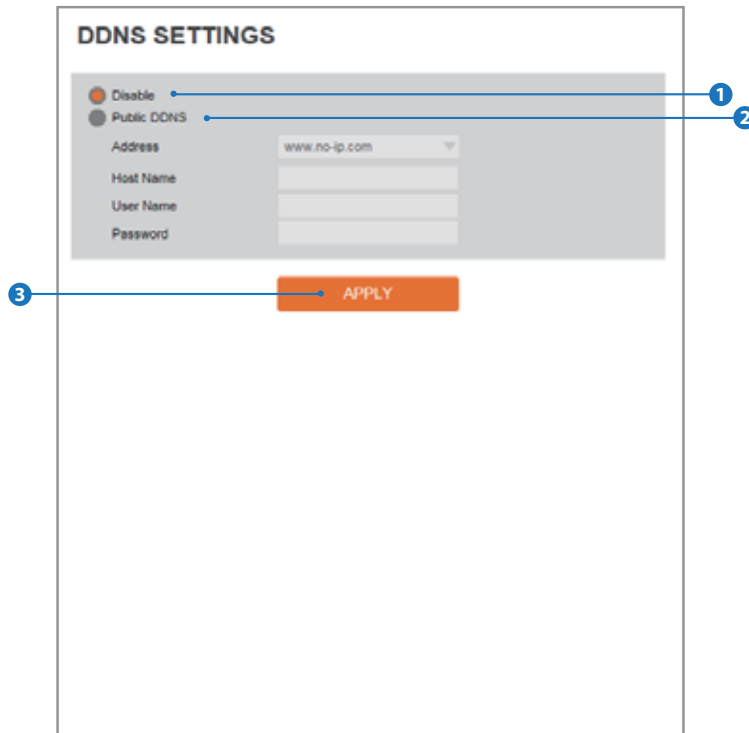

1 DDNS Disable

If it is selected, DDNS service does not work.

2 Public DDNS

To use public DDNS service, select a site address listed in the list. After filling out the Host Name of the site, the setup is completed by entering User Name and Password registered in that DDNS site.

DDNS Provider	Site Address
DynDNS	www.dyndns.com
No-IP	www.no-ip.com

⊠ If you setup DDNS properly, the IP address of your camera will be updated automatically whenever IP address is changed or system is rebooted.

⊠ If IP updating to DDNS site is failed, camera will keep retrying in 1min. interval.

3 Click 'Apply' to make above setting effective.

Setup - FTP Settings

FTP SETTINGS

General Setting

Off On

Server information

FTP Server Address

FTP Upload Path /

FTP Port 21

User ID

Password

APPLY

To transfer / save the image to the relevant sites through FTP, then FTP needs to be setup.

1 General Setting

FTP function can be enable or disable.

2 FTP Server Address

Define FTP Server IP Address. If IP Address form is incorrect, a Message box will be shown to try again.

3 FTP Upload Path

Define a path in FTP server to store video. For the path name, English Alphabets, numbers and special characters (/ ~ !@ \$ ^ () _ - { } [] ; ,) can be used.

4 FTP Port

Define the FTP Server Port. If Port is not appropriate, it is impossible to access to FTP Server.

5 User ID

Define User ID to access to the FTP Server. Fill out the correct User ID registered in the FTP Server.

6 Password

Define Password to access to the FTP Server. Fill out the correct Password registered in the FTP Server.

7 Click 'Apply' to make above setting effective.

☒ Refer the above screen image for the example.

Setup - SMTP Settings

The screenshot shows the 'SMTP SETTINGS' configuration page. It is divided into three main sections: 'General Setting', 'Account information', and 'Mail Contents'. At the bottom is an 'APPLY' button. Numbered callouts (1-11) point to specific elements: 1 points to the 'General Setting' section header; 2 points to the 'Mode' radio buttons (PLAIN and SSL/TLS); 3 points to the 'SMTP Server Address' text input field; 4 points to the 'PORT' text input field; 5 points to the 'User ID' text input field; 6 points to the 'Password' text input field; 7 points to the 'E-Mail Sender' text input field; 8 points to the 'E-Mail Receiver' text input field; 9 points to the 'Title' text input field; 10 points to the 'Message' text area; and 11 points to the 'APPLY' button.

To send / save the image to the relevant sites by Email, SMTP needs to be setup.

1 General Setting

SMTP function can be enable or disable.

2 Mode

Select Security mode of SMTP from Plain or SSL / TLS. After checking account setup of your SMTP Server, you may select one.

3 SMTP Server Address

Define the SMTP Server Address. If the IP Address form is incorrect, a Message box will be shown to try again.

4 Port

Define the Port used in the Plain or SSL / TLS security mode in the above.

5 User ID

Define the User ID to access to SMTP Server. Fill out the correct User ID registered in the SMTP Server.

6 Password

Define the Password to access to SMTP Server. Fill out the correct Password registered in the SMTP Server.

7 E-Mail Sender

Define the e-mail address of E-Mail Sender. It will be displayed as the sender when the camera sends an E-mail.

8 E-Mail Receiver

Define the e-mail address of E-Mail Receiver. It will be displayed as the Receiver when the camera sends an E-mail.

9 Title

Define the title of the E-Mail when the camera sends an E-mail.

☒ The title of the Email is limited to 40 characters including the spaces.

10 Message

Define the contents of E-Mail when camera sends an E-mail. The message of the Email is limited to 40 characters including the spaces.

11 Click 'Apply' to make above setting effective.

Setup - SNMP Settings

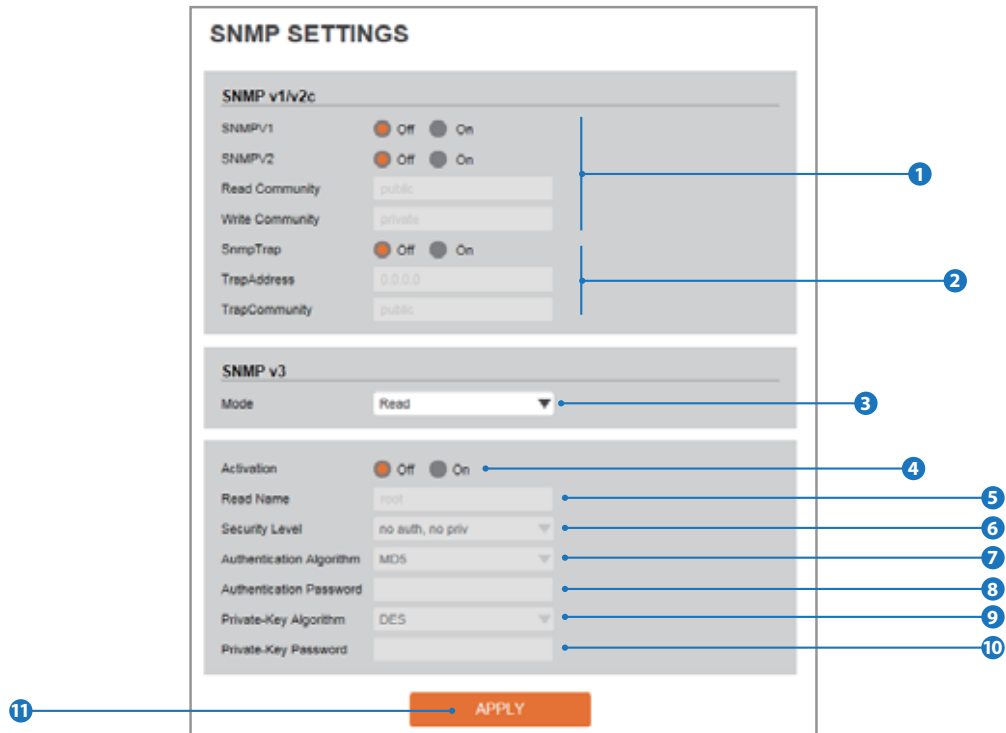

1 SNMPv1/SNMPv2

Select the SNMPv1/SNMPv2 option and type the names of Read community and Write community.

SNMP trap can be used to check periodically for operational thresholds or failures that are defined in the MIB.

2 SNMP Trap

SNMP trap can be enable or disable.

SNMPv3 contains cryptographic security, a higher security level, which allows you to set the Authentication password and the Encryption password.

3 Mode

Select the either Read or Read/Write mode.

4 Activation

It can be enable or disable selected mode.

5 Read/Write name

Define Read name and Write name.

6 Security Level

Select one of no auth, no priv/auth , no priv/auth, priv

7 Authentication Algorithm

Select MD5 or SHA as the authentication method.

8 Authentication Password

The Authentication Password is an encryption for authentication and they are at least 8 digits and up to 30 digits allowed.

9 Private-Key Algorithm

Select DES or AES as the encryption algorithm.

10 Private-Key Password

Information protection password is a private encryption and they are at least 8 digits and up to 30 digits allowed.

11 Click 'Apply' to make above setting effective.

Setup - RTSP Information

The screenshot shows the 'RTSP INFORMATION' configuration page. It is divided into several sections: 'RTSP Global Setting' with a 'Target Stream' dropdown menu; 'Session Timeout' with a 'Time Out' input field and a checkbox for '[Default: Off, 30~120]'; 'Rtp Multicast' with a 'MULTICAST' toggle (Off/On), and input fields for 'IP' (0.0.0.0), 'PORT' (0, range [1024-60000]), and 'TTL' (0, range [0-255]); an orange 'APPLY' button; and a table at the bottom showing RTSP connection information. Five blue callout lines with numbered circles (1-5) point to the 'Target Stream' dropdown, the 'Time Out' input, the 'Rtp Multicast' input fields, the 'APPLY' button, and the table header respectively.

No	Remote IP	Port	Type
1	192.168.1.39	49622	TCP

1 Target Stream

Select the channel you want to set.

2 Time out

Set the RTSP time out.

⊠ The session is disconnected after the specified time out.

3 RTP Multicast

Check RTP Multicast On/Off. To activate RTP Multicast,

1. Click "On" button

2. Enter accessible RTP Multicast IP, port for video stream control, RTP packet TTL

3. Click "Apply" button.

⊠ It is possible to set each RTP Multicast for CH1~3.

4 Click 'Apply' to make above setting effective.

⊠ Click this button when completed setup each channels.

5 It shows RTSP Connection information.

Setup - Action Rules Configuration

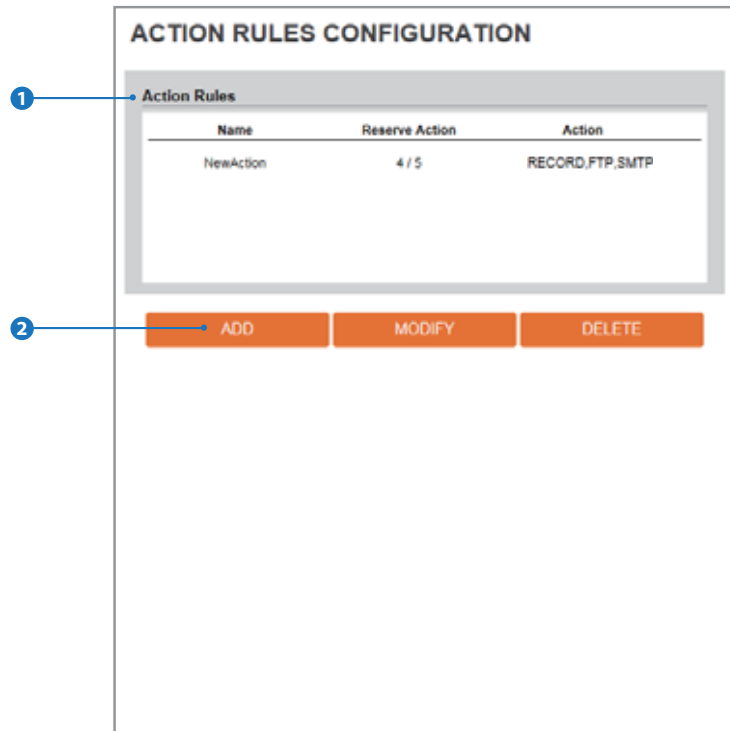

1 Action rules List

It indicates the custom action rule information added to Action rules list.

2 Click 'Add' to add custom action rules.

- ⊠ Click 'Modify' to modify selected item from the action rules list.
- ⊠ Click 'Delete' to delete selected item from the action rules list.

Setup - Action Rules Add/Modify

ACTION RULES CONFIGURATION

General Setting

Name:

Action1:

Action2:

Action3:

Action4:

Action5:

- 1 Name**
Define name of action rules.
- 2 Action1 ~ Action5**
Select the action to take If the event occurs.
- 3 Click 'Save' to save the current settings.**
⊠ Click 'Cancel' to return to the previous menu.

Setup - Image Transfer Configuration

1 Pre/Post Alarm Image

Image Transfer due to event is configured by setting Image transfer rate and Pre/Post alarm duration.

	Descriptions
Number of Image	Define Number of image transferred per second.
Pre-alarm Duration	Define duration of image transfer before an event.
Post-alarm Duration	Define duration of image transfer after an event.

2 Click 'Apply' to make above setting effective.

Setup - Event Rules Configuration

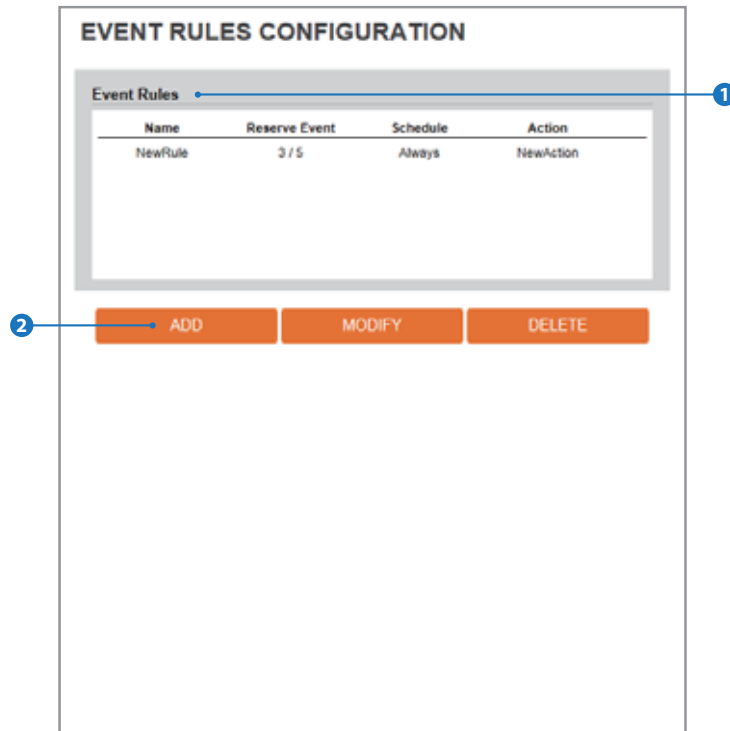

1 Event Rules List

It indicates the custom Event Rule information added to Event Rules list.

2 Click 'Add' to add custom event rules.

- ⊠ Click 'Modify' to modify selected item from the event rules list.
- ⊠ Click 'Delete' to delete selected item from the event rules list.

Setup - Event Rules Configuration

The screenshot shows a form titled "EVENT RULES CONFIGURATION" with three main sections: "General", "Event Condition", and "Action".

- General:** A text input field labeled "Name" containing the text "NewRule". A blue line with a circled "1" points to this field.
- Event Condition:** A dropdown menu labeled "Event" with "NONE" selected. A blue line with a circled "2" points to this dropdown.
- Action:** A dropdown menu labeled "Rules" with "NONE" selected. A blue line with a circled "3" points to this dropdown.
- Buttons:** Two orange buttons labeled "SAVE" and "CANCEL" are located at the bottom of the form. A blue line with a circled "4" points to the "SAVE" button.

- 1 Name**
Define the Event rule name.
- 2 Event**
Select the event among motion detection, schedule.
 - ⊗ Click 'Cancel' to return to the previous setting.
 - ⊗ You need a event one more.
- 3 Rules**
Select the action rule defined in the Trigger Action-Action rule menu.
- 4** Click 'Save' to save the current settings.
 - ⊗ Click 'Cancel' to return to the previous setting.

Setup - Motion Detection Configuration

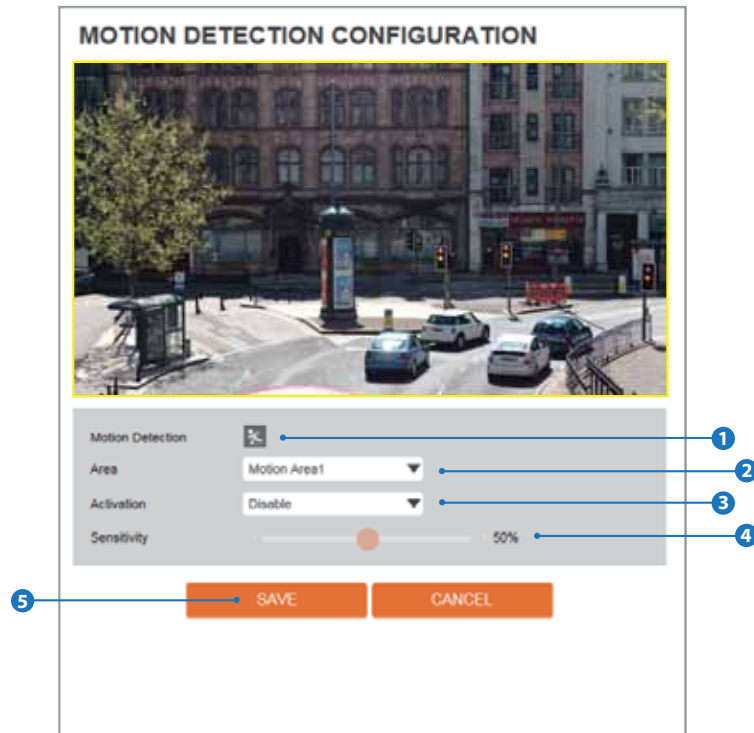

1 Motion Detection

It shows the Motion event status.

☒ Event Alert Icon (🔔) appears if 'Motion Detection' is activated.

2 Area

Set the motion detected area.

☒ You can set up to four areas.

3 Activation

Enable or Disable motion detection function.

4 Sensitivity

Define the sensitivity of motion detection. If High value is selected, it will detect very small motion while it becomes relatively insensitive when Low value is selected.

5 Click 'Save' to save the current settings.

☒ Click 'Cancel' to return to the previous setting.

Setup - Temperature

The screenshot shows a web interface for configuring temperature settings. The title is "TEMPERATURE". Below it is a "General Setting" section with three rows: "Mode" with a dropdown menu set to "Fahrenheit", "Threshold" with a text input set to "150" and a range "[122 ~ 212]", and "Temperature" with a text input set to "118 °F". Below these settings is an orange "APPLY" button. Four blue callout lines with numbered circles (1-4) point to the Mode dropdown, the Threshold input, the Temperature input, and the APPLY button respectively.

- 1 Mode**
Select the either Fahrenheit and Celsius.
- 2 Threshold**
Define the temperature at which the event trigger is occurred.
- 3 Temperature**
It indicates the current temperature of the IP camera.
- 4** Click 'Apply' to make above setting effective.

Setup - Record Management

RECORD CONFIGURATION

Record Global Setting

Target Stream: NONE

SAVE

RECORDING LIST

Name	Enabled	File Type	Storage	Continuous
RECORD0	X	TS	SD Card	Off
RECORD1	X	TS	SD Card	Off

MODIFY

- 1 Target Stream**
Select the channel you want to record video.
- 2** Click 'Save' to save the current settings.
- 3 Recording List**
Display the information about the recording settings.
- 4** Click 'Modify' to modify the selected item in the recording list.

Setup - Record Configuration

The screenshot shows a 'RECORD CONFIGURATION' dialog box. It contains a 'Record Settings' section with the following fields: 'Enabled' (radio buttons for Off and On), 'File Type' (dropdown menu showing 'TS'), 'Storage' (dropdown menu showing 'SD Card'), 'Continuous' (radio buttons for Off and On), 'Pre Duration' (input field with '5' and range '[0 - 5]'), and 'Post Duration' (input field with '5' and range '[1 - 240]'). At the bottom are 'SAVE' and 'CANCEL' buttons. Numbered callouts 1 through 7 point to these elements: 1 to the 'Enabled' radio buttons, 2 to the 'File Type' dropdown, 3 to the 'Storage' dropdown, 4 to the 'Continuous' radio buttons, 5 to the 'Pre Duration' input field, 6 to the 'Post Duration' input field, and 7 to the 'SAVE' button.

- 1 Enabled**
The Recording function can be enable or disable.
- 2 File Type**
Select the recording file type.
☒ Currently only supports Ts Type.
- 3 Storage**
Select the storage type.
- 4 Continuous**
If continous mode is turned on, Start the continuous recording without any other setting.
- 5 Pre Duration**
Define duration of recording before an event.
- 6 Post Duration**
Define duration of image transfer after an event.
- 7 Click 'Save' to save the current settings.**
☒ Click 'Cancel' to return to the previous setting.

Setup - Recording List

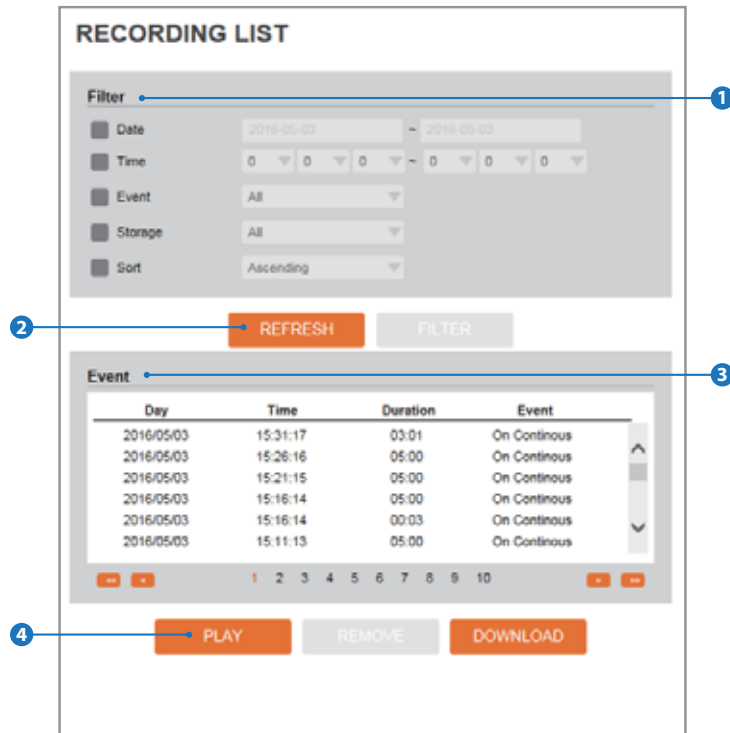

1 Filter

Select the date / time, event, sort or storage format to filter the recorded video.

2 Click the 'Refresh' button to refresh the records list.

☒ Click 'Filter' to view the filtered recorded video.

3 Recording List

Display the information to the recording video.

4 Click 'Play' to view the selected item in list of recorded video.

☒ Click 'Remove' to delete the selected item in list of recorded video.

☒ Click 'Download' to download the selected item in list of recorded video.

Setup - Recording Video

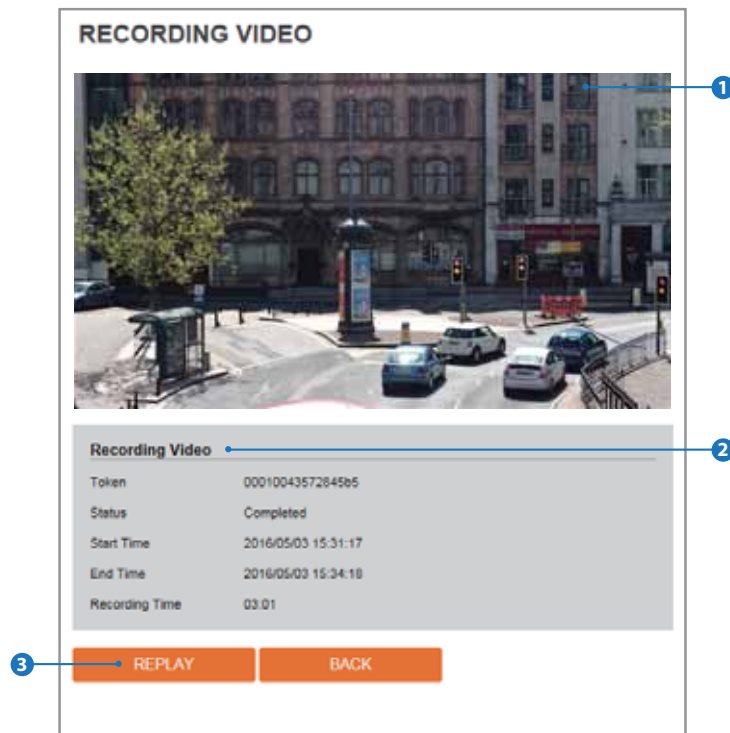

- 1 Recording Video Viewer**
Play the recorded video.
- 2 Recording Video Information**
Display the information about the recorded video.
- 3 Click 'Replay' to view the recorded video again.**
⌘ Click 'Back' to return to the previous menu.

Setup - Storage Configuration

STORAGE CONFIGURATION			
Storage List			
Name	Size	Used(%)	Available
sdcard0	14.0G	20%	10.7G

Display the SD card information mounted from device.

☒ When you select the item in Storage list, You can set the functions related to the SD card.

Setup - Storage Configuration

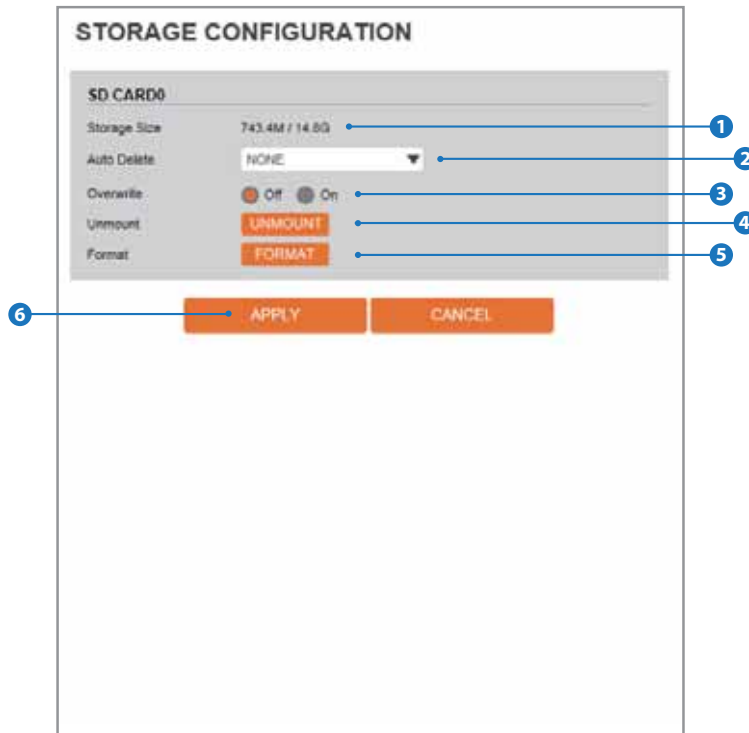

1 Storage Size

Total capacity of SD card and the remainder of it are displayed.

2 Auto Delete

Select the period for Auto delete. The image data stored before period will be deleted automatically.

☒ Delete all stored image older than selected time.

3 Overwrite

If it is set ON and remained space of SD card reach to less than 8MB, new data will start to be overwritten on the oldest data. However, if it is set OFF and remained space of SD card reach to less than 8MB, image recording will be stopped.

4 Unmount

remove the SD card from the device.

5 Format

Delete the all contents that stored in SD card.

6 Click 'Apply' to make above setting effective.

☒ Click 'Cancel' to return to the previous setting.

Setup - IP Address Filter Configuration

The screenshot shows the 'IP ADDRESS FILTER CONFIGURATION' interface. It is divided into two main sections: 'General' and 'Filtered IP Address'.
1. In the 'General' section, there are two radio buttons: 'Enable' (selected) and 'Disable'.
2. Below the radio buttons is a dropdown menu for 'IP Filter Type' with 'Allow' selected.
3. An orange 'APPLY' button is located below the 'General' section.
4. The 'Filtered IP Address' section contains a large, empty list box with a vertical scrollbar.
5. Below the list box is an input field for 'IP Address' with a placeholder '[Invalid]'.
6. At the bottom, there are three orange buttons: 'ADD', 'REMOVE', and 'REMOVE ALL'.

1 IP Address Filter

IP filter function can be enable or disable.

2 IP Filter Type

The address in the list of Filtered IP Address will be allowed or denied access to this product.

⊠ if select Deny, all ip address can't access without in the list of IP Addresses.

3 Click 'Apply' to make above setting effective.

4 Filtered IP Address

Display the filtered IP address.

5 IP Address

Define the IP address you want to apply the IP filter.

6 Click 'Add' to add the ip address to the list.

⊠ Click 'Remove' to remove the ip address selected in the list.

⊠ Click 'Remove All' to remove all ip in the list.

Setup - RTSP Authentication Configuration



- 1 RTSP Authentication**
RTSP Authentication can be enable or disable.
- 2** Click 'Apply' to make above setting effective.

Setup - IEEE 802.1X Configuration

The screenshot shows the 'IEEE 802.1X CONFIGURATION' window. Under the 'General Setting' section, there are several fields: 'IEEE 802.1x' with 'On' and 'Off' radio buttons; 'Protocol' with a dropdown menu set to 'MD5'; 'EAPOL Version' with a dropdown menu set to '1'; 'ID' with a text input field; 'Password' with a text input field; 'Verify' with a text input field; 'CA Certificate' with a dropdown menu set to 'NONE'; and 'Certificate' with a dropdown menu set to 'NONE'. At the bottom right of the configuration area is an orange 'APPLY' button. Numbered callouts (1-9) point to each of these elements: 1 points to the IEEE 802.1x status, 2 to the Protocol dropdown, 3 to the EAPOL Version dropdown, 4 to the ID field, 5 to the Password field, 6 to the Verify field, 7 to the CA Certificate dropdown, 8 to the Certificate dropdown, and 9 to the APPLY button.

The feature is needed when connecting the camera to the network protected by the IEEE 802.1X.

1 IEEE 802.1x

The IEEE 802.1x feature can be enable or disable.

2 Protocol

MD5: It provides one-way password-based network authentication of the client.

PEAP: It is similar to TTLS in that it does not require a certificate on the client side.

TTLS/MD5: It does not require a certificate on the client side.

TLS: It relies on client-side and server-side certificates to perform authentication.

3 EAPOL Version

Select the EAPOL Version.

4 ID

Type the ID to identify the client in the IEEE 802.1X authentication server.

5 Password

Type the Password to identify the client in the IEEE 802.1X authentication server.

6 Verify

Verify Password.

7 CA Certificate

Select the CA certificate required for TLS, TTLS, and PEAP authentication.

8 Certificate

Select the client certificate required for TLS authentication

9 Click 'Apply' to make above setting effective.

Setup - HTTPS Configuration

The screenshot shows the 'HTTPS CONFIGURATION' interface. At the top, there is a red warning message: '1. If no certificates are available go to certificates to manage.' Below this, there are two main sections: 'Certificates' and 'HTTPS connection Policy'. The 'Certificates' section has a 'Certificate' dropdown menu currently set to 'NONE', with a blue callout '1' pointing to it. The 'HTTPS connection Policy' section has three dropdown menus for 'Administrator', 'Operator', and 'Viewer', all set to 'HTTP and HTTPS', with a blue callout '2' pointing to the 'Operator' dropdown. At the bottom of the form is an orange 'APPLY' button, with a blue callout '3' pointing to it.

HTTPS encrypts session data over SSL or TLS protocols instead of using plain text in socket communications.

1 Certificate

Select an installed certificate.

- ⊗ If you can not select a certificate, please install the certificate from the Security->Certificates menu.

2 HTTPS connection Policy

Select one of "HTTP", "HTTPS", "HTTP and HTTPS" depending on the connected user authority.

3 Click 'Apply' to make above setting effective.

- ⊗ When HTTPS mode is chosen, input `https://<IP Address>` to connect to the camera.

Setup - Certificates Configuration

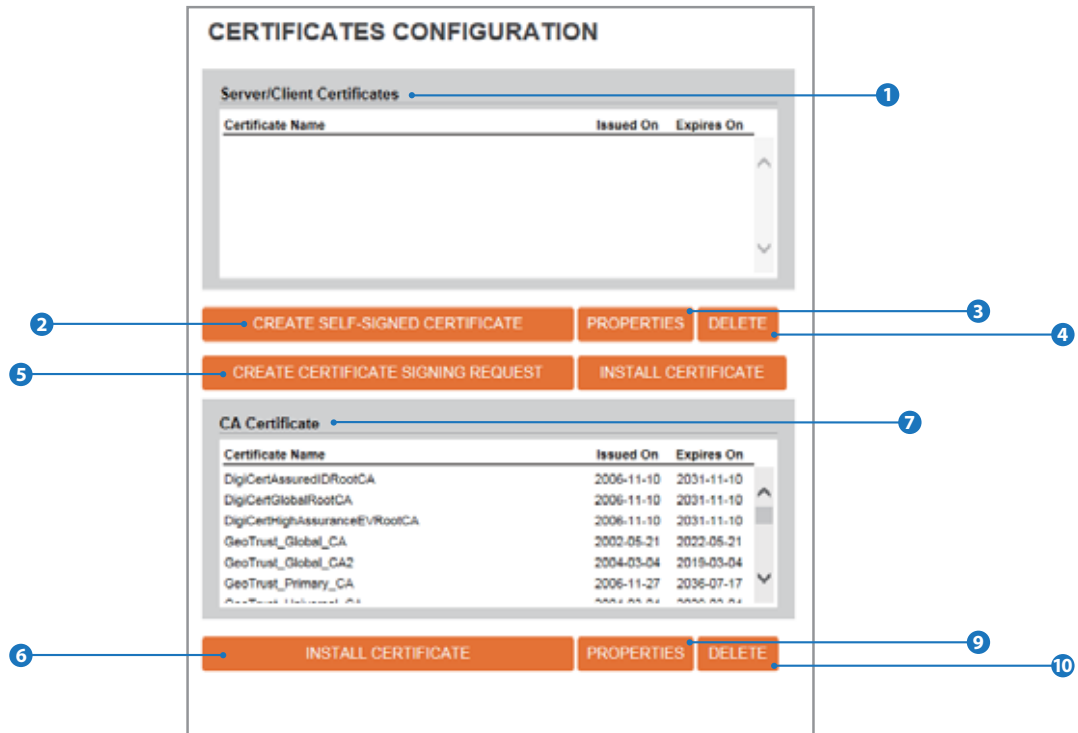

1 Server/Client Certificates
It show the installed certificates.

2 Create Self-Signed Certificate
A self-signed SSL certificate is an identity certificate signed by its own creator. but they are considered to be less trust-worthy.

3 Properties
Shows information about the selected certificate.

4 Delete
Delete the selected certificate.

5 Create Certificate signing request
This is the encoded data that contains the necessary information for issuing the certificate.
⊗ they must be filled in when creating the CSR (Certificate Signing Request).

6 Install Certificate
Install Certification

7 CA Certificate
It show the installed CA certificates.

8 Install CA Certificate
Install Certification, see the detail page.

9 Properties
Shows information about the selected certificate.

10 Delete
Delete the selected CA certificate.

Setup - Certificates Configuration

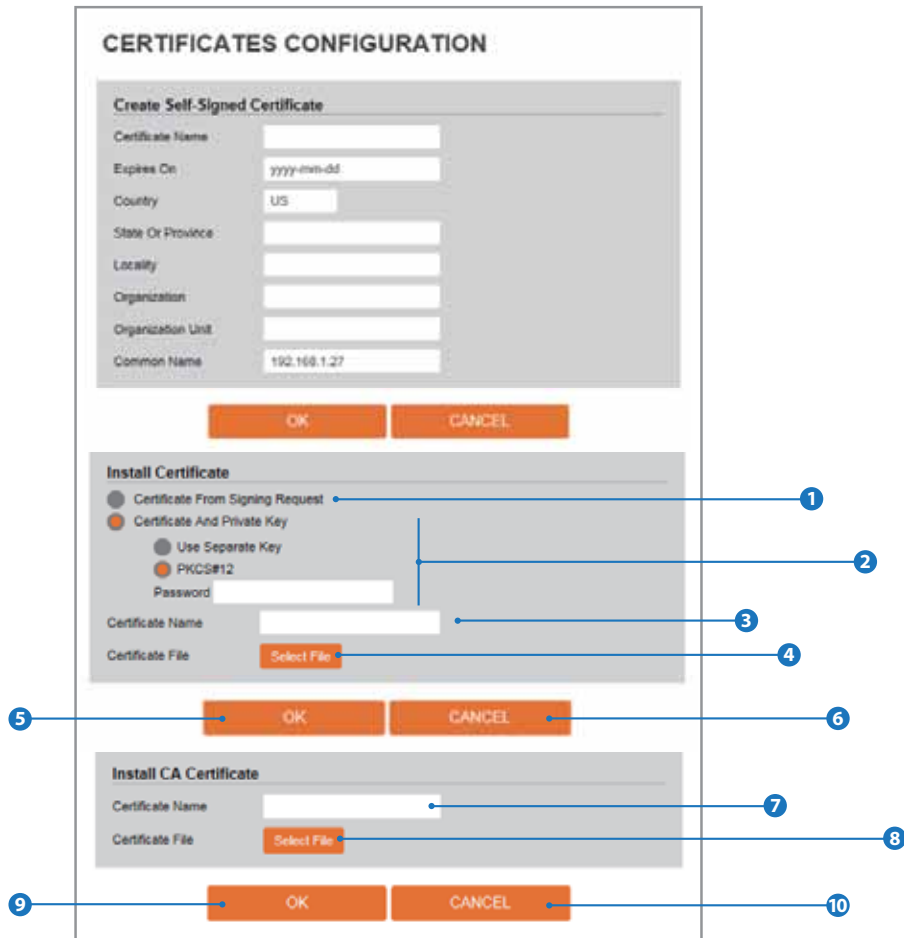

Detail for Install Certification.

- 1 Certificate From Signing Request**
Select to install signed certificate returned from the CA.
- 2 Certificate And Private Key**
Select to install Certificate And Private Key to install a certificate and private key.
Use Separate Key: Too install certificate uploading Certificate and Private Key file.
PKCS#12 : "PKCS#12" is cryptography standard. if you want to install using PKCS#12, must enter the password.
- 3 Certificate Name**
Enter a unique name to identify certificate.
- 4 Select File**
Choose certification file.
- 5 OK**
Request installing certificate.

- 6 Cancel**
Cancel install certificate and then back to certificates configuration.

Detail for Install CA Certification.

- 7 Certificate Name**
Enter a unique name to identify CA certificate.
- 8 Select File**
Choose CA certification file
- 9 OK**
Request installing CA certificate.
- 10 Cancel**
Cancel install CA certificate and then back to certificates configuration.

Setup - Service Configuration

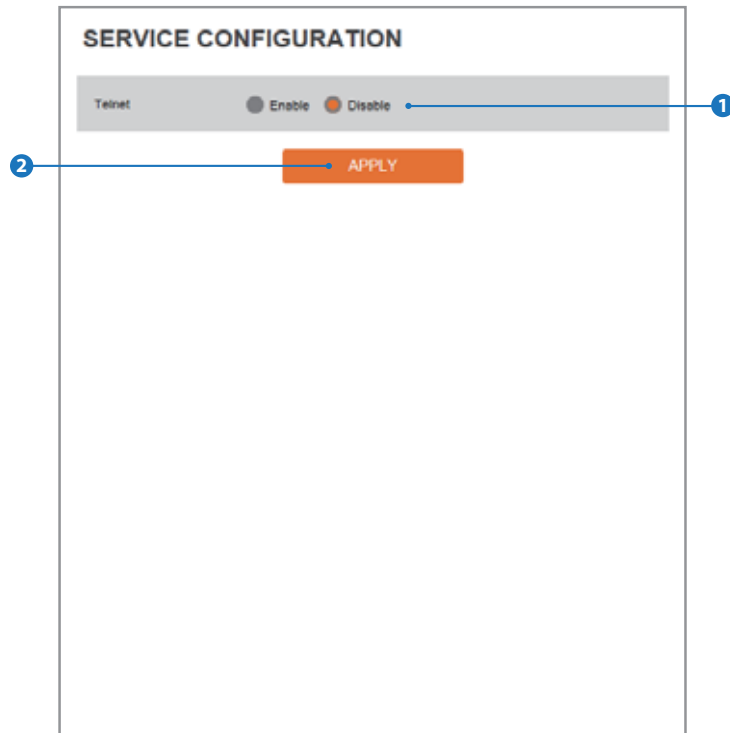

- 1 Telnet**
The Telnet function can be enable or disable.
- 2** Click 'Apply' to make above setting effective.

Setup - System Information

SYSTEM INFORMATION

Device Name: IP_Camera

APPLY

Model Name	NSFx-ALAH
Manufacturer	IPNC
Max Resolution	1080p
Max Framerate	30 fps
Photo Resistor(CDS)	SUPPORT
Alarm In	NOT SUPPORT
Relay out	NOT SUPPORT
Audio	NOT SUPPORT
Optical Zoom	NOT SUPPORT
Digital Zoom	NOT SUPPORT
PTZ	NOT SUPPORT

System Capability information.

- 1 Device Name**
You can define the device name.
- 6** Click 'Apply' to make above setting effective.

Setup - Firmware Update

FIRMWARE UPDATE

Notice

1. Do not power off during update. It may cause fatal system damage.
2. If Explorer was closed abnormally or a user closed accidentally while uploading firmware file, please try again after 30 seconds.
3. Please do not select other menus while updating firmware file.

Version Information

System	2016.4.22_0.9.3
Camera	0.1

Web update

Firmware File

FTP user information

FTP Server Address	<input type="text" value="ftp.davcc.tv"/>
FTP Port	<input type="text" value="21"/>
User ID	<input type="text" value="davmpix"/>
Password	<input type="password" value="*****"/>
FTP Upload Path	<input type="text" value="/"/>

1 Version Information

It shows the current Firmware Version in the system.

2 Web Update

Select the Firmware file in your computer by clicking [Select file] button.

3 Start F / W Update

Click this button to start update. Progress of uploading will be displayed using Progress Bar. If you assign the wrong file name, an error message will be shown.

⚠ Warning:

1. Do not turn off the power of camera during the Firmware update. Otherwise, the system can be stuck to be unstable. If updating is finished, the system will be rebooted automatically.
2. Please make sure to check the 'Notice' shown on screen. If firmware update is completed, the camera will reboot automatically and 'Setup window' will be closed.

Setup - Firmware Update

4 FTP Server Address

Define FTP Server IP Address. If IP Address form is incorrect, a Message box will be shown to try again.

5 FTP Port

Define the FTP Server Port. If Port is not appropriate, it is impossible to access to FTP Server.

6 User ID

Define User ID to access to the FTP Server. Fill out the correct User ID registered in the FTP Server.

7 Password

Define Password to access to the FTP Server. Fill out the correct Password registered in the FTP Server.

8 FTP Upload Path

Define a path in FTP server to store video. For the path name, English Alphabets, numbers and special characters (/ ~ ! @ \$ ^ () _ - { } [] ; ,) can be used.

9 Click 'Save' to make above setting effective.

SAVE	Save FTP information
CANCEL	Click 'Cancel' to return to the previous setting.
CHECK	Check the F/W file and if the file exists, 'F/W Update' button will appear and click it to update for F/W.

Setup - Date & Time Settings

The screenshot shows the 'DATE&TIME SETTINGS' interface. It is divided into three main sections: 'TimeZone Setup', 'Current Date & Time', and 'New Camera Date & Time'.
1. 'TimeZone Setup' contains a dropdown menu for 'TimeZone' set to '(GMT 00) Greenwich Mean Time, Lisbon, London.' and an 'APPLY' button.
2. 'Current Date & Time' shows 'Date' as '2005-01-01' and 'Time' as '00:02:38'.
3. 'New Camera Date & Time' has three radio button options: 'Synchronize with my computer' (selected), 'Setup manually', and 'Synchronize with time sever Time Zone'.
4. Under 'Synchronize with my computer', 'Date' is '2016-04-22' and 'Time' is '18:28:59'.
5. Under 'Setup manually', 'Date' is '2005-01-01' and 'Time' is '00:00:00'.
6. Under 'Synchronize with time sever Time Zone', 'TimeZone' is 'time-a.nist.gov'.
An 'APPLY' button is located at the bottom of the 'New Camera Date & Time' section.

1 TimeZone Setup

Choose TimeZone for camera. It will be activated after clicking 'Apply' button.

⊠ Prior to setting below 'New Camera Date & Time', set correct Timezone first.

2 Current Date & Time

Shows the current date and time setting in the Camera.

3 Synchronize with my computer

Set the date / time using those of PC currently connected.

4 Setup manually

Set the date / time by typing manually.

5 Synchronize with time sever Time Zone

Choose time server available to connect to current camera. Date & Time will be updated automatically every hour when connected.

6 Click 'Apply' to make above setting effective.

Setup - DST Settings

The screenshot shows a web interface titled "DST SETTINGS". It is divided into two main sections: "General Setting" and "Date&Time Settings".

- General Setting:** Contains two radio buttons, "Off" (selected) and "On". A blue line with a circled "1" points to this section.
- Date&Time Settings:** Contains two rows of dropdown menus. The first row is labeled "Start Time" and the second "End Time". Each row has dropdowns for month (Jan), day (First), day of week (Sun), and time (0 o'clock). A blue line with a circled "2" points to this section.
- APPLY:** An orange button located below the settings. A blue line with a circled "3" points to this button.

Daylight Saving Time (DST) is the practice of setting the clocks forward one hour from standard time during the summer months, and back again in the fall, in order to make better use of natural daylight.

- 1 General Setting**
DST function can be enable or disable.
- 2 Date&Time Settings**
Set the Start time and end time that the DST apply.
- 3** Click 'Apply' to make above setting effective.

Setup - Users Management

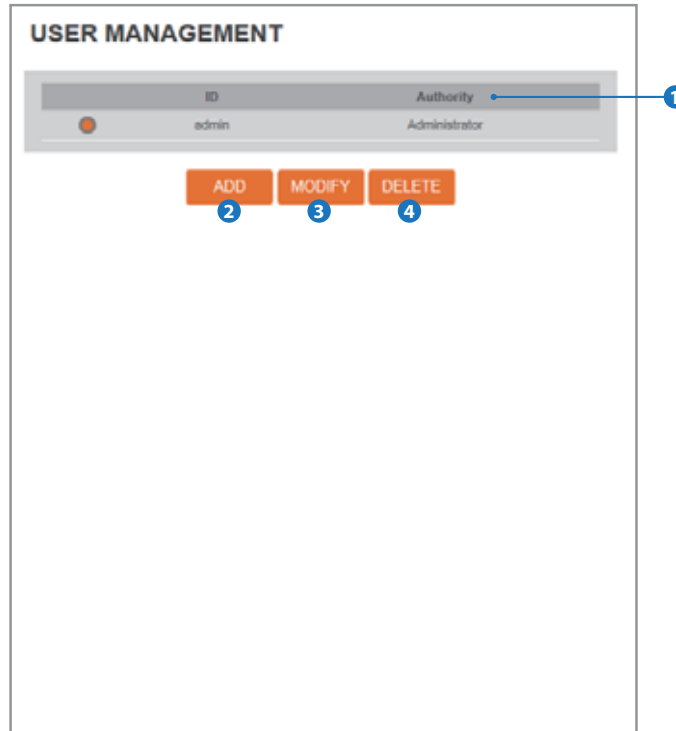

1 Users

List all the user accounts for authentication.

2 Add

Register a new user

ID	Enter a new user ID except Admin since it exists.
Password	Enter the user Password.
Verify	Enter the user Password again for verification.
User Authority	Select Operator or Viewer. Viewer : Only monitoring is allowed. Operator : Most of the functions are allowed except 'Setup'. Administrator : All functions are allowed.

⊗ The ID and Password are limited to 10 characters.

Click 'Apply' to make above setting effective.

⊗ Click 'Cancel' to return to the previous menu.

3 Modify

Modify the information of the user accounts registered.
For admin account, only Password function can be modified.

4 Delete

Delete the selected user account. Admin account cannot be deleted.

Setup - System Log

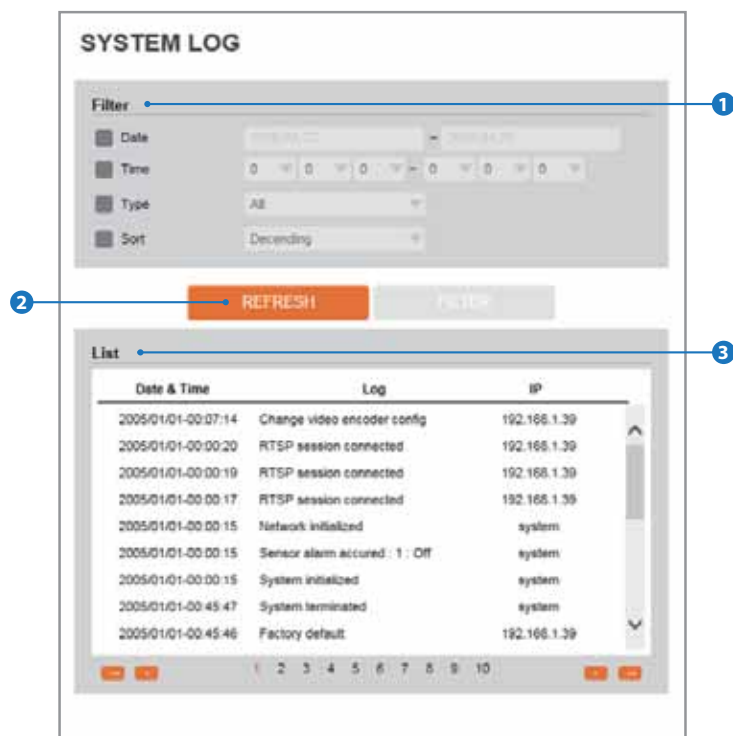

1 Filter

Select a date, sort or type of log to filter the log.

2 Click the 'Refresh' button to refresh the log list.

☒ Click 'Filter' to view the filtered log.

3 System Log List

The filtered log is displayed.

Setup - Factory Reset



- 1 Reset to the factory defaults Return the setup to the factory default.

All

Reset all Settings to the factory defaults.

Except Network Settings

Except Network related settings , reset all others to the factory default.

- 2 Click 'Apply' to make above setting effective.

Setup - Restart

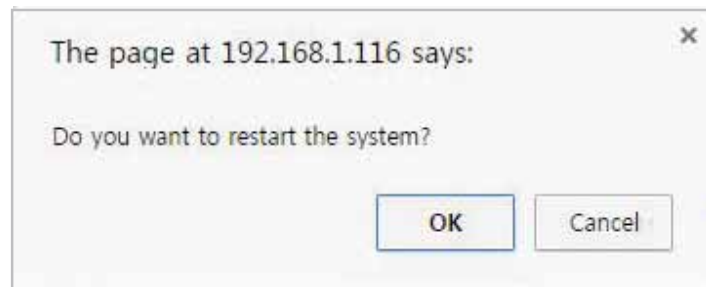

If you click the 'RESTART' menu, a message box will be shown to confirm. Click the 'Ok' button to restart.

Appendix

A : Current TCP/IP Settings

i If your IP settings are obtained automatically, you could use the MS-DOS prompt (or Command Prompt) to determine your IP address. For information on how to do this, please read the FAQ.

1. Windows 2000 or XP Users

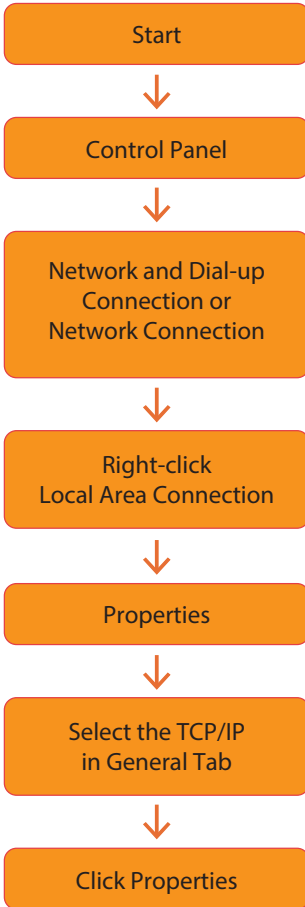

Under the 'General' tab of the TCP/IP Properties you will see your IP address information.

2. Windows Vista or 7 Users

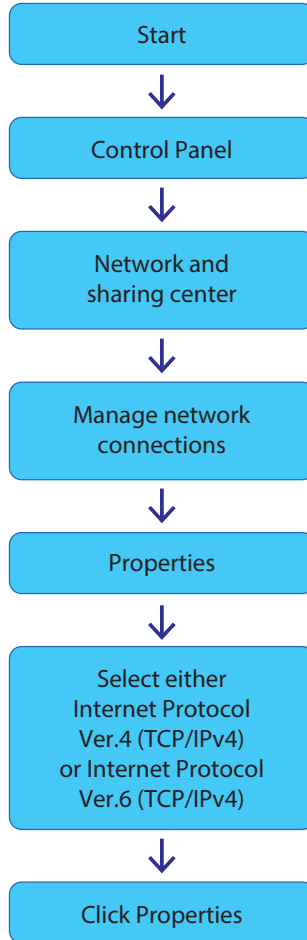

Under the 'General' tab of the TCP/IP Properties you will see your IP address information.

Appendix - B : Changing IP address and subnet mask

1. Windows 2000 or XP Users

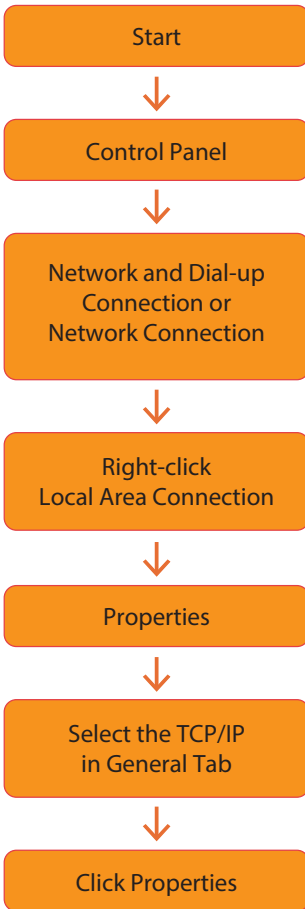

Select 'Use the following IP address'

2. Windows Vista or 7 Users

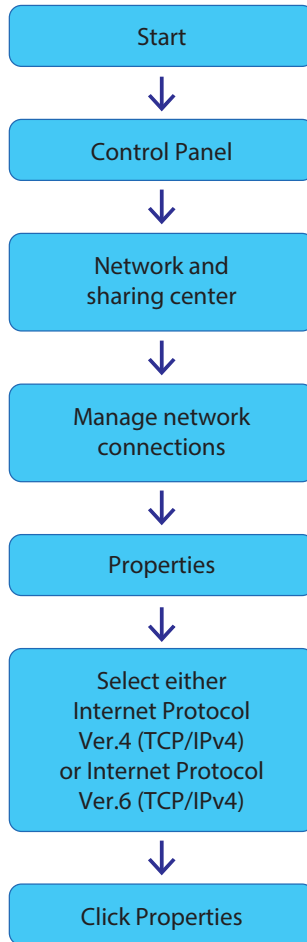

Select 'Use the following IP address'

Appendix - C : Port Forwarding

After assigning the IP Camera a web server port and video server port you must use Port Forwarding. (for cases A, B)

Please consult your router's user guide on how to correctly configure Port Forwarding.

For your convenience, we have provided two example configurations.

1. For D-Link DI-604 broadband routers:

- 1) Open a web browser and type http://192.168.0.1 into your Address bar. (the default IP address to access the router)
- 2) You will have to supply your User Name and Password to log onto the router. Default from factory. (User Name: admin Password: [leave blank])
- 3) Select the "1 Advanced" tab and click "2 Virtual Server" menu.

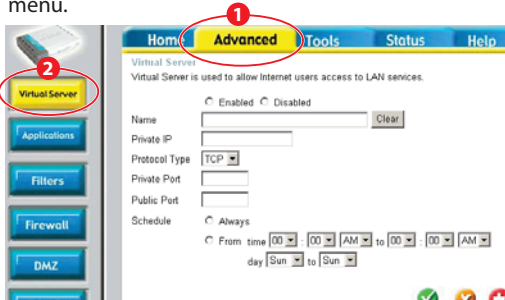

- 4) Click "3 Apply" button after inputting proper values. The example is as below

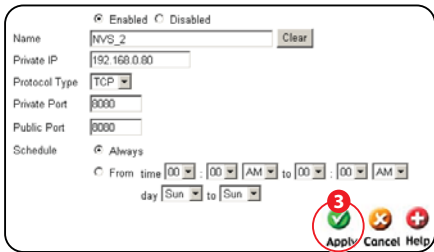

Enabled / Disabled	Select "Enabled".
Name	Input IVS name.
Private IP	Input IVS address.
Protocol Type	Select "TCP".
Private Port / Public Port	Input IVS Web Server Port.
Schedule	Select "Always"

- 5) If 'Setting Saved' shows, click [Continue] button.
- 6) With the same method as above, add Video Server Port.
- 7) The Web Server Port, Video Server Port and 2 Audio Ports shows in "Virtual Server List" as below.

Virtual Servers List

Name	Private IP	Protocol	Schedule
✓ NVS_2	192.168.0.80	TCP 8080/8080	always
✓ NVS_2	192.168.0.80	TCP 7777/7777	always
✓ NVS_2	192.168.0.80	TCP 7778/7778	always
✓ NVS_2	192.168.0.80	TCP 7779/7779	always
✓ NVS_2	192.168.0.80	TCP 7780/7780	always

2. For Linksys BEFSR41 Cable/DSL routers:

- 1) Open a web browser and type http://192.168.1.1 into you Address bar. (the default IP address to access the router)
- 2) You will have to supply your User Name and Password to log onto the router. Default from factory (User Name:[leave blank] Password: admin)
- 3) Select "4 Applications & Gaming" from the menu bar.

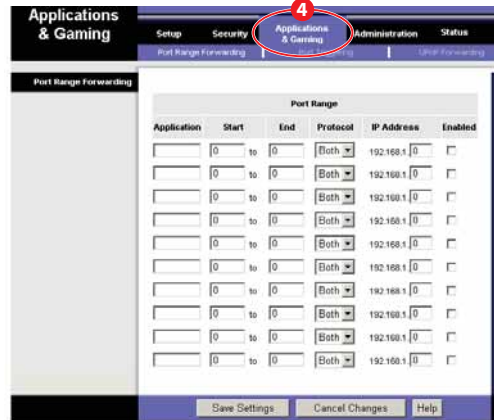

- 4) Input port numbers in "5 Port Range" as below and click "6 Save Setting" button. Both of Web Server Port and Video Server Port should be added. The example is as below.

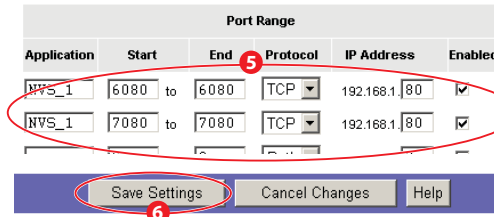

Enabled / Disabled	Input IP Camera name.
Start / End	Input IP Camera Web Server Port and Video Server Port. Start should be same as End. Both of Web Server Port and Video Server Port should be added.
Protocol	Select "TCP" in Protocol option.
IP Address	Input IP Camera IP Address.
Enabled	Check the square.

Appendix - C : Port Forwarding

3. For Netgear RP614 routers:

- 1) Input http://192.168.0.1 in address bar of web browser.
http://192.168.0.1 is the default IP address.
- 2) If it asks ID and password, input admin as ID and password as password.
- 3) Click "Port Forwarding" in "Advanced".
- 4) Click "1 Add Custom Service" button in Port Forwarding page.

Port Forwarding

The screenshot shows the 'Port Forwarding' configuration page. At the top, there is a 'Service Name' dropdown menu set to 'SERVICES' and a 'Server IP Address' field with '192', '168', and '0' in its segments, followed by an 'Add' button. Below this is a table with columns: '#', 'Enable', 'Service Name', 'Start Port', 'End Port', and 'Server IP Address'. Under the table, there are three buttons: 'Add Custom Service' (circled in red with a red '1'), 'Edit Service', and 'Delete Service'. At the bottom, there are 'Apply' and 'Cancel' buttons.

- 5) Input proper values in "Ports - Custom Services" page as below.

Ports - Custom Services

The screenshot shows the 'Ports - Custom Services' configuration page. It has an 'Enable' checkbox which is unchecked. Below it are fields for 'Service Name', 'Starting Port' (with a '(1~65535)' hint), 'Ending Port' (with a '(1~65535)' hint), and 'Server IP Address' (with '192', '168', and '0' in its segments). At the bottom, there are 'Add' and 'Cancel' buttons. The 'Add' button is circled in red with a red '2' next to it.

Enable	Check it.
Service Name	Input IP Camera name.
Starting/ Ending Port	Input IP Camera Web Server port. Starting Port should be same as Ending Port.
Server IP Address	Input IP Camera IP Address.

- 6) Click "2 Add" button.
- 7) With the same method as above, add Video Server Port.
- 8) Click "Apply" button to finish Port Forwarding.

Appendix - FAQ

1. My POWER light is not on?

Power is not being supplied to the unit. Please use the power supply shipped with the unit and verify that a power source is active from the attached power outlet used to connect the adapter. You can test this by plugging in any other electrical device and verify its operation. After using the power supply shipped with the product, checking the power source, and reinserting the power connector into the IP Camera, please call our Support Center. The power supply may be defective.

2. My ACTIVE light is not flashing?

Verify the power supply to the unit. Power off the unit and back on again, wait 1 minute, if the ACTIVE light still does not begin to flash, you will have to set the unit to its factory default (THIS WILL DELETE ANY CONFIGURATION AND SET THE UNIT TO THE FACTORY DEFAULTS). Power on the unit and insert the end of a paper clip into the small recessed opening on the back of the unit. Use the clip to press the button located within that opening.

3. My LINK light is not flashing or solid?

Verify the cable connection. 99% of the time the cable's connection to the unit is causing this problem. Try using a different network cable or crossover cable (for PC connection only). Try reinserting the cable, if this still doesn't solve the problem call our Support Center.

4. I can access the video server on my LAN, but not from the Internet.

Verify that your router (if applicable) has port forwarding properly configured. If accessing from our DDNS service, verify correct serial number. Firewall issues may prevent user access.

5. How do I open an MS-DOS or Command Prompt?

Start > (All) Programs > Accessories > Command Prompt

6. How do I find out my IP address information if my settings were automatically detected?

- 1) Open a Command Prompt
- 2) At the prompt type - "ipconfig / all" (without the quotes)
- 3) Near the end of the information supplied, should be your current IP address, subnet mask, default gateway and DNS servers

7. I can't connect!!

In the case of a connection failure.

Modem Reboot > Modem Reboot Finished > Router Reboot > Router Reboot Finished > IP Camera Reboot > IP Camera Reboot Finish > Verify DDNS and IP Camera connection, if applicable.

8. How do I "PING" an IP address?

- 1) Open an MS-DOS (or Command) prompt
- 2) At the prompt type - "ping xxx.xxx.xxx.xxx" (without the quotes and replace the "x"s with an IP address)
- 3) Press Enter

9. I'm accessing my video server remotely over the Internet and the video stream is choppy, is this normal?

Yes. The frames per second received remotely are determined by your bandwidth capabilities both at your site where the IP Camera is installed and your remote location. The lower of the two sites will determine how fast your video stream is received. It is recommended to have at least a 256Kb/sec upstream connection from the site where the IP Camera is installed. Lower speeds will operate properly, but provide poor remote performance. The Faster the Internet connection at both ends, the faster the video stream.

10. How do I enable or check VLC on my browser

Internet Explorer

Open Internet Explorer > Tools on the menu bar > Internet Options > Security Tab > Custom Level > Scroll down and verify that you are prompted or have enabled plug-ins to be downloaded and executed. > click OK > restart browser.

Chrome

Open Chrome > Chrome menu settings > Advanced settings > Individual information - content settings > Run automatically

11. How do I reset the unit to factory defaults?

Refer to the previous functions page and find the reset button. Power ON the unit and use a paper clip to push the reset button within that opening. You should then see the ACTIVE light turn off and after a few seconds the ACTIVE light will begin to flash, signifying a successful reboot. If the ACTIVE light does not turn off after depressing the reset button, please try holding the button in for a few seconds and releasing. YOU WILL LOSE ALL DATA THAT HAD BEEN ENTERED PREVIOUSLY AND THE IP CAMERA WILL BE SET TO ITS FACTORY RESETS.

Specifications - Dimension

Unit: mm

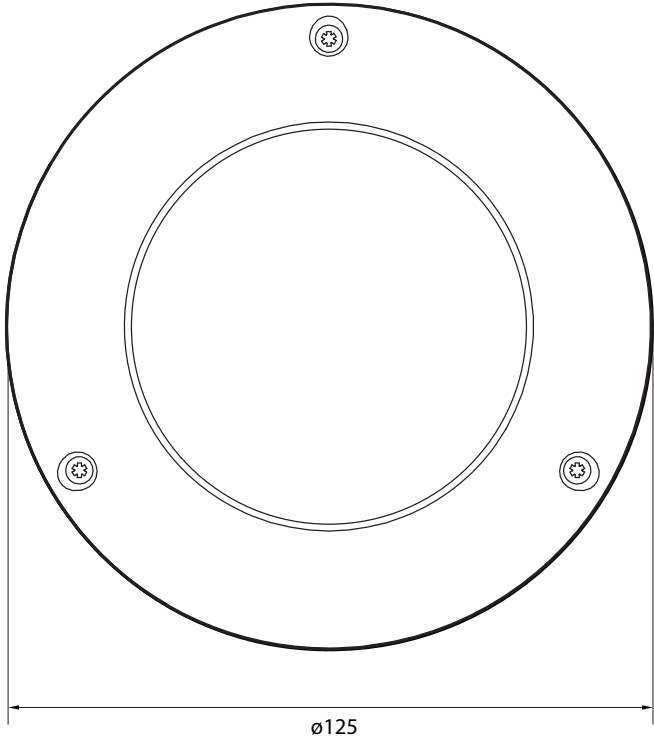
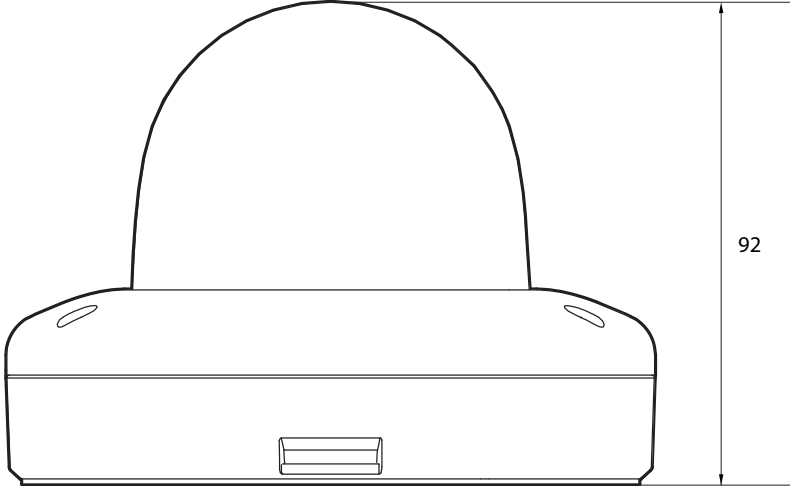



Complete Surveillance Solutions

Headquarters Office: 5436 W Crenshaw St, Tampa, FL 33634
Sales Office: 16220 Bloomfield Ave., Cerritos, California, USA 90703

PH: 866-446-3595 | FAX: 813-888-9262

www.Digital-Watchdog.com

technicalsupport@dwcc.tv

Technical Support PH:

USA & Canada 1+ (866) 446-3595

International 1+ (813) 888-9555

French Canadian 1+ (514) 360-1309

Technical Support Hours: Monday-Friday
9:00am to 8:00pm Eastern Standard Time