

# GV-IPCam H.264

---

## *User's Manual*



Before attempting to connect or operate this product,  
please read these instructions carefully and save this manual for future use.

ICH264TIV212-A



© 2014 GeoVision, Inc. All rights reserved.

Under the copyright laws, this manual may not be copied, in whole or in part, without the written consent of GeoVision.

Every effort has been made to ensure that the information in this manual is accurate. GeoVision, Inc. makes no expressed or implied warranty of any kind and assumes no responsibility for errors or omissions. No liability is assumed for incidental or consequential damages arising from the use of the information or products contained herein. Features and specifications are subject to change without notice. **Note: no memory card slot or local storage function for Argentina.**

GeoVision, Inc.  
9F, No. 246, Sec. 1, Neihu Rd.,  
Neihu District, Taipei, Taiwan  
Tel: +886-2-8797-8377  
Fax: +886-2-8797-8335  
<http://www.geovision.com.tw>

Trademarks used in this manual: *GeoVision*, the *GeoVision* logo and GV series products are trademarks of GeoVision, Inc. *Windows* and *Windows XP* are registered trademarks of Microsoft Corporation.

June 2014

## **Safety Notice**

### **FCC Compliance for GV-CBW120/220**

This device complies with Part 15 of the FCC Rules. Operation is subject to the following two conditions: (1) this device may not cause harmful interference and (2) this device must accept any interference received, including interference that may cause undesired operation of the device.

### **UL Certification for GV-MFD120/130/220/320/520**

The GV-IPCAM H.264 uses a 3.0V CR2032 Lithium battery as the power supply for its internal real-time clock (RTC). The battery should not be replaced unless required!

If the battery does need replacing, please observe the following:

- Danger of Explosion if battery is incorrectly replaced
- Replace only with the same or equivalent battery, as recommended by the manufacturer
- Dispose of used batteries according to the manufacturer's instructions

## Preface

Welcome to the *GV-IPCAM H.264 User's Manual*.

The GV-IPCAM H.264 has a series of models designed to meet different needs. This Manual is designed for the following models and firmware versions:

---

**Note:** To upgrade the camera firmware from V2.07 or earlier to the latest version, back up the files in the camera's storage device first before the upgrade and it is required to re-format the memory card after the upgrade.

---

Model	Model Number		Firmware Version
Box Camera	GV-BX120D	Varifocal Lens	V2.11
	GV-BX130D-0	Varifocal Lens	
	GV-BX130D-1	Fixed Lens	
	GV-BX140DW	Varifocal Lens	
	GV-BX220D-2		
	GV-BX220D-3		
	GV-BX320D-0		
	GV-BX320D-1		
GV-BX520D			



Model	Model Number		Firmware Version		
Box Camera	GV-BX1200-0F ~ 2F GV-BX1300-0F ~ 2F GV-BX1500-0F ~ 2F GV-BX2400-0F ~ 2F GV-BX2500-0F ~ 2F GV-BX3400-0F ~ 2F	Fixed Lens	V2.11		
	GV-BX1200-3V GV-BX1300-3V GV-BX1500-3V GV-BX2400-3V GV-BX2500-3V	Varifocal Lens			
	GV-BX2400-4V GV-BX3400-4V GV-BX3400-5V GV-BX5300-6V				
	GV-BX1500-8F GV-BX2400-8F GV-BX2500-8F GV-BX3400-8F GV-BX5300-8F	Fixed Lens			
	Ultra Box Camera	GV-UBX1301 Series GV-UBX2301 Series GV-UBX3301 Series		Fixed Lens	V2.11
	Target Box Camera	GV-EBX1100-0F		Fixed Lens	Coming
		GV-EBX1100-1F			V1.00

Model	Model Number		Firmware Version
IR Arctic Box Camera	GV-BX120D-E GV-BX220D-E GV-BX320D-E GV-BX520D-E	Varifocal Lens	V2.11
	GV-BX1500-E		
	GV-BX2400-E GV-BX3400-E GV-BX5300-E		
Mini Fixed Dome	GV-MFD120 GV-MFD130 GV-MFD220 GV-MFD320 GV-MFD520	Fixed Lens	V2.11
	GV-MFD1501 Series GV-MFD2401 Series GV-MFD2501 Series GV-MFD3401 Series GV-MFD5301 Series		

<b>Model</b>	<b>Model Number</b>		<b>Firmware Version</b>
Mini Fixed Rugged Dome	GV-MDR120 GV-MDR220 GV-MDR320 GV-MDR520	Fixed Lens	V2.11
	GV-MDR1500 Series GV-MDR2400 Series GV-MDR2500 Series GV-MDR3400 Series GV-MDR5300 Series		V2.12
Target Mini Fixed Dome	GV-EFD1100-0F	Fixed Lens	Coming
	GV-EFD1100-1F		V1.00
Target Bullet Camera	GV-EBL1100-0F GV-EBL1100-1F	Fixed Lens	V1.00
Ultra Bullet Camera	GV-UBL1211 GV-UBL1511 GV-UBL2411 GV-UBL2511 GV-UBL3411	Motorized Varifocal Lens	V2.11
	GV-UBL1301 Series GV-UBL2401 Series GV-UBL3401 Series	Fixed Lens	

Model	Model Number		Firmware Version		
Bullet Camera	GV-BL120D GV-BL130D GV-BL220D GV-BL320D	Varifocal Lens	V2.11		
	GV-BL1200 GV-BL1300 GV-BL1500 GV-BL2400 GV-BL2500 GV-BL3400				
	GV-BL1210 GV-BL1510 GV-BL2410 GV-BL2510 GV-BL3410			Motorized Varifocal Lens	
	GV-BL5310				V2.12
	PTZ Camera	GV-PTZ010D		NTSC	V1.09
				PAL	
	PT Camera	GV-PT130D GV-PT220D GV-PT320D	Fixed Lens	V2.11	

Model	Model Number	Firmware Version	
Vandal Proof IP Dome	GV-VD120D (IK10+, Transparent Cover) GV-VD121D (IK10+, Smoked Cover) GV-VD122D (IK7, Transparent Cover) GV-VD123D (IK7, Smoked Cover)	Varifocal Lens	V2.11
	GV-VD220D (IK10+, Transparent Cover) GV-VD221D (IK10+, Smoked Cover) GV-VD222D (IK7, Transparent Cover) GV-VD223D (IK7, Smoked Cover)		
	GV-VD320D (IK10+, Transparent Cover) GV-VD321D (IK10+, Smoked Cover) GV-VD322D (IK7, Transparent Cover) GV-VD323D (IK7, Smoked Cover)		
	GV-VD1500 GV-VD2400 GV-VD2500 GV-VD3400		

Model	Model Number		Firmware Version
Vandal Proof IP Dome	GV-VD1530 GV-VD2430 GV-VD2530 GV-VD3430	Varifocal Lens, high power IR LEDs	Coming
	GV-VD1540 GV-VD2440 GV-VD2540 GV-VD3440	Motorized Varifocal Lens, high power IR LEDs	V2.11
	GV-VD5340		V2.12
	GV-VD2540-E	Motorized Varifocal Lens, high power IR LEDs, extreme temperatures	V2.11
	GV-VD5340-E		V2.12
	Advanced Cube Camera	GV-CA120 GV-CA220 GV-CAW120 GV-CAW220	Fixed Lens
Cube Camera	GV-CB120 GV-CB220 GV-CBW120 GV-CBW220	Fixed Lens	V2.11

Model	Model Number		Firmware Version	
Fixed IP Dome	GV-FD120D GV-FD220D GV-FD320D		V2.11	
	GV-FD1200 GV-FD1500 GV-FD2400 GV-FD2500 GV-FD3400 GV-FD5300		Varifocal Lens	V2.12
	GV-FD1210 GV-FD1510 GV-FD2410 GV-FD2510 GV-FD3410		Motorized Varifocal Lens	

# Contents

Preface.....	II
Contents.....	X
Naming and Definition.....	XXI
Options.....	XXII
Note for Connecting to GV-System.....	XXV
Note for Recording .....	XXVI
Note for Adjusting Focus and Zoom.....	XXVII
Note for Installing Camera Outdoor.....	XXVIII
Note for Closing the Bullet Camera Cover.....	XXX
Note for USB Storage and WiFi Adapter .....	XXXI
<b>Chapter 1 Introduction .....</b>	<b>1</b>
<b>1.1 System Requirement .....</b>	<b>1</b>
<b>Chapter 2 Box Camera .....</b>	<b>2</b>
<b>2.1 Packing List.....</b>	<b>6</b>
<b>2.2 Features.....</b>	<b>7</b>
2.2.1 Wide Dynamic Range Pro .....	9
For GV-IPCam H.264 models that support WDR, the WDR effect is achieved through software programming. ....	9
<b>2.3 Overview.....</b>	<b>10</b>
2.3.1 GV-BX120D / 130D Series / 140DW / 220D Series / 320D Series / 520D.....	10
2.3.2 GV-BX1200 Series / 1300 Series / 1500 Series / 2400 Series / 2500 Series / 3400 Series / 5300 Series.....	12
<b>2.4 Connecting the Camera.....</b>	<b>14</b>
2.4.1 GV-BX120D / 130D Series / 140DW / 220D Series / 320D Series / 520D.....	14
2.4.2 GV-BX1200 Series / 1300 Series / 1500 Series / 2400	



Series / 2500 Series / 3400 Series / 5300 Series.....	16
<b>2.5 Accessory Installation .....</b>	<b>18</b>
2.5.1 C-Mount Lenses.....	18
2.5.2 Infrared Illuminators (Optional) .....	19
<b>2.6 I/O Terminal Block .....</b>	<b>20</b>
2.6.1 Pin Assignment.....	20
2.6.2 Connecting to GV-Relay V2 (Optional) .....	21
<b>Chapter 3 Ultra Box Camera .....</b>	<b>22</b>
<b>3.1 Packing List.....</b>	<b>23</b>
<b>3.2 Features.....</b>	<b>24</b>
<b>3.3 Overview.....</b>	<b>25</b>
<b>3.4 Installation.....</b>	<b>26</b>
<b>3.5 Connecting the Camera.....</b>	<b>28</b>
<b>Chapter 4 Target Box Camera .....</b>	<b>29</b>
<b>4.1 Packing List.....</b>	<b>29</b>
<b>4.2 Features.....</b>	<b>30</b>
<b>4.3 Overview.....</b>	<b>31</b>
<b>4.4 Installation.....</b>	<b>32</b>
<b>4.5 Connecting the Camera.....</b>	<b>34</b>
<b>Chapter 5 IR Arctic Box Camera .....</b>	<b>35</b>
<b>5.1 Packing List.....</b>	<b>36</b>
<b>5.2 Features.....</b>	<b>37</b>
<b>5.3 Overview.....</b>	<b>39</b>
<b>5.4 Installation.....</b>	<b>40</b>
<b>5.5 Connecting the Camera.....</b>	<b>44</b>
5.5.1 Wire Definition.....	44
<b>5.6 Notice for Using the IR Arctic Box Camera .....</b>	<b>46</b>
5.6.1 Enabling IR LED after Loading Default .....	46

5.6.2 Disabling Status LED under Low Light Conditions .....	47
---	----

## **Chapter 6 Mini Fixed Dome & Mini Fixed Rugged Dome.....48**

<b>6.1 Packing List.....</b>	<b>51</b>
<b>6.2 Features.....</b>	<b>52</b>
<b>6.3 Overview.....</b>	<b>55</b>
6.3.1 GV-MFD120 / 130 / 220 / 320 / 520 .....	55
6.3.2 GV-MFD1501 Series / 2401 Series / 2501 Series / 3401 Series / 5301 Series.....	57
6.3.3 GV-MDR120 / 220 / 320 / 520 .....	59
<b>6.4 Installation.....</b>	<b>62</b>
6.4.1 GV-MFD Series.....	62
6.4.2 GV-MDR Series .....	64
<b>6.5 Connecting the Camera.....</b>	<b>69</b>
6.5.1 Wire Definition.....	69
6.5.2 Power and Network Connection .....	70
6.5.3 Vehicle Installation .....	71

## **Chapter 7 Target Mini Fixed Dome.....72**

<b>7.1 Packing List.....</b>	<b>72</b>
<b>7.2 Features.....</b>	<b>73</b>
<b>7.3 Overview.....</b>	<b>74</b>
<b>7.4 Installation.....</b>	<b>75</b>
<b>7.5 Connecting the Camera.....</b>	<b>78</b>

## **Chapter 8 Bullet Camera .....79**

<b>8.1 Packing List.....</b>	<b>81</b>
<b>8.2 Features.....</b>	<b>82</b>
<b>8.3 Overview.....</b>	<b>84</b>
<b>8.4 Installation.....</b>	<b>85</b>

8.4.1	Connecting the Camera .....	87
8.4.2	Adjusting the Angles .....	91
8.4.3	Adjusting Lens and Inserting a Memory Card .....	95
8.4.4	Installing the Sun-Shield Cover .....	98
<b>Chapter 9</b>	<b>Ultra Bullet Camera .....</b>	<b>99</b>
<b>9.1</b>	<b>Packing List.....</b>	<b>101</b>
<b>9.2</b>	<b>Features.....</b>	<b>102</b>
<b>9.3</b>	<b>Overview.....</b>	<b>104</b>
<b>9.4</b>	<b>Installation.....</b>	<b>106</b>
9.4.1	Connecting the Camera .....	109
9.4.2	Waterproofing the Cable.....	112
<b>Chapter 10</b>	<b>Target Bullet Camera .....</b>	<b>115</b>
<b>10.1</b>	<b>Packing List.....</b>	<b>115</b>
<b>10.2</b>	<b>Features.....</b>	<b>116</b>
<b>10.3</b>	<b>Overview.....</b>	<b>117</b>
<b>10.4</b>	<b>Installation.....</b>	<b>119</b>
<b>10.5</b>	<b>Connecting the Camera.....</b>	<b>122</b>
<b>Chapter 11</b>	<b>PTZ Camera .....</b>	<b>124</b>
<b>11.1</b>	<b>Packing List.....</b>	<b>125</b>
<b>11.2</b>	<b>Features.....</b>	<b>126</b>
<b>11.3</b>	<b>Overview.....</b>	<b>127</b>
<b>11.4</b>	<b>Installation.....</b>	<b>129</b>
11.4.1	Ceiling Mount.....	129
11.4.2	L-Shaped Wall Mount.....	131
<b>11.5</b>	<b>Connecting the Camera.....</b>	<b>134</b>
<b>11.6</b>	<b>Focus Adjustment.....</b>	<b>135</b>
<b>11.7</b>	<b>I/O Terminal Block.....</b>	<b>136</b>
11.7.1	Pin Assignment .....	136

11.7.2 Voltage Load Expansion (Optional) .....	137
<b>11.8 PTZ Control .....</b>	<b>138</b>
11.8.1 The PTZ Control Panel.....	138
11.8.2 Automatic Focus .....	140
11.8.3 PTZ Camera Settings.....	140
11.8.4 Image Settings .....	142
11.8.5 Preset Settings.....	145
11.8.6 Sequence Settings .....	148
11.8.7 Auto Pan Settings .....	150
11.8.8 System Configuration.....	153
<b>Chapter 12 PT Camera .....</b>	<b>154</b>
<b>12.1 Packing List.....</b>	<b>154</b>
<b>12.2 Features.....</b>	<b>156</b>
<b>12.3 Overview.....</b>	<b>157</b>
<b>12.4 Installation.....</b>	<b>159</b>
<b>12.5 Connecting the Camera.....</b>	<b>159</b>
<b>12.6 Focus Adjustment.....</b>	<b>159</b>
<b>12.7 I/O Terminal Block.....</b>	<b>160</b>
12.7.1 Pin Assignment .....	160
12.7.2 Voltage Load Expansion (Optional) .....	160
<b>12.8 PT Control .....</b>	<b>161</b>
<b>Chapter 13 Vandal Proof IP Dome (Part I) .....</b>	<b>163</b>
<b>13.1 Packing List.....</b>	<b>165</b>
<b>13.2 Features.....</b>	<b>166</b>
<b>13.3 Overview.....</b>	<b>168</b>
<b>13.4 Installation.....</b>	<b>170</b>
13.4.1 Hard-Ceiling Mount .....	170
13.4.2 In-Ceiling Mount.....	175
<b>13.5 Connecting the Camera.....</b>	<b>178</b>

13.5.1	Wire Definition.....	178
13.5.2	Power Connection.....	179
13.5.3	Voltage Load Expansion (Optional) .....	180
<b>Chapter 14</b>	<b>Vandal Proof IP Dome (Part II) .....</b>	<b>181</b>
<b>14.1</b>	<b>Packing List.....</b>	<b>183</b>
<b>14.2</b>	<b>Features.....</b>	<b>186</b>
<b>14.3</b>	<b>Overview.....</b>	<b>188</b>
<b>14.4</b>	<b>Installation.....</b>	<b>190</b>
<b>14.5</b>	<b>Connecting the Camera.....</b>	<b>200</b>
14.5.1	Power Connection.....	200
14.5.2	I/O Device Connections.....	200
14.5.3	Voltage Load Expansion (Optional) .....	201
<b>Chapter 15</b>	<b>Fixed IP Dome .....</b>	<b>202</b>
<b>15.1</b>	<b>Packing List.....</b>	<b>204</b>
15.1.1	Packing List for Hard-Ceiling Mount.....	204
15.1.2	Packing List for In-Ceiling Mount .....	205
<b>15.2</b>	<b>Features.....</b>	<b>206</b>
<b>15.3</b>	<b>Overview.....</b>	<b>208</b>
<b>15.4</b>	<b>Installation.....</b>	<b>210</b>
15.4.1	Hard-Ceiling Mount .....	210
15.4.2	In-Ceiling Mount.....	214
15.4.3	Wall-Surface Mount.....	218
<b>15.5</b>	<b>Connecting the Camera.....</b>	<b>220</b>
<b>15.6</b>	<b>I/O Terminal Block.....</b>	<b>221</b>
15.6.1	Pin Assignment .....	221
15.6.2	Voltage Load Expansion (Optional) .....	222
<b>Chapter 16</b>	<b>Cube Camera .....</b>	<b>223</b>
<b>16.1</b>	<b>Packing List.....</b>	<b>224</b>

16.2 Features.....	225
16.3 Overview.....	226
16.4 Installation.....	227
16.5 Connecting the Camera.....	229
<b>Chapter 17 Advanced Cube Camera.....</b>	<b>230</b>
17.1 Packing List.....	231
17.2 Features.....	232
17.3 Overview.....	233
17.4 Installation.....	235
17.5 Connecting the Camera.....	237
<b>Chapter 18 Getting Started .....</b>	<b>238</b>
18.1 Accessing the Live View.....	238
18.1.1 Checking the Dynamic IP Address.....	240
18.1.2 Configuring the IP Address.....	242
18.1.3 Configuring the Wireless Connection.....	244
18.2 Adjusting Image Clarity .....	248
18.2.1 Using Focus Adjustment Cap .....	251
18.2.2 Locations of Adjustment Screws .....	252
18.3 Configuring the Basics.....	254
<b>Chapter 19 Accessing the Camera.....</b>	<b>255</b>
19.1 Accessing Your Surveillance Images .....	256
19.2 Functions Featured on the Main Page.....	257
19.2.1 The Live View Window .....	258
19.2.2 The Control Panel of the Live View Window .....	263
19.2.3 Snapshot of Live Video.....	269
19.2.4 Video Recording.....	269
19.2.5 Picture-in-Picture and Picture-and-Picture View.....	270
19.2.6 Alarm Notification .....	273

19.2.7 Video and Audio Configuration .....	275
19.2.8 Remote Configuration .....	277
19.2.9 Camera Name Display .....	277
19.2.10 Image Enhancement .....	277
19.2.11 Visual PTZ .....	278
19.2.12 Digital PTZ .....	281
19.2.13 I/O Control.....	283
19.2.14 Visual Automation .....	284
19.2.15 Network Status.....	285

## **Chapter 20 Administrator Mode .....286**

<b>20.1 Video and Motion .....</b>	<b>289</b>
20.1.1 Video Settings.....	290
20.1.2 Motion Detection .....	299
20.1.3 Privacy Mask.....	301
20.1.4 Text Overlay.....	302
20.1.5 Tampering Alarm.....	304
20.1.6 Visual Automation .....	306
<b>20.2 I/O Settings.....</b>	<b>308</b>
20.2.1 Input Settings .....	309
20.2.2 Output Settings .....	311
20.2.3 PTZ Settings .....	312
<b>20.3 Events and Alerts.....</b>	<b>313</b>
20.3.1 E-mail .....	314
20.3.2 FTP.....	316
20.3.3 Center V2.....	319
20.3.4 VSM.....	321
20.3.5 Backup Center .....	323
20.3.6 Video Gateway / Recording Server.....	326
20.3.7 ViewLog Server.....	328
20.3.8 RTSP .....	329

20.3.9 Speaker .....	330
<b>20.4 Monitoring .....</b>	<b>331</b>
20.4.1 Monitoring Settings for Target Series.....	332
<b>20.5 Recording Schedule .....</b>	<b>333</b>
20.5.1 Recording Schedule Settings .....	333
20.5.2 I/O Monitoring Settings.....	334
<b>20.6 Remote ViewLog .....</b>	<b>335</b>
<b>20.7 Network .....</b>	<b>336</b>
20.7.1 LAN Configuration.....	336
20.7.2 Wireless Client Mode .....	338
20.7.3 Advanced TCP/IP.....	340
20.7.4 IP Filter Settings.....	344
20.7.5 SNMP Settings.....	345
<b>20.8 Management.....</b>	<b>347</b>
20.8.1 Date & Time Settings .....	347
20.8.2 Storage Settings.....	348
20.8.3 User Account .....	352
20.8.4 Log Information .....	354
20.8.5 System Log.....	356
20.8.6 Tools.....	358
20.8.7 Language.....	360
<b>Chapter 21 Recording and Playback .....</b>	<b>361</b>
<b>21.1 Recording.....</b>	<b>361</b>
<b>21.2 Playback .....</b>	<b>362</b>
21.2.1 Playback from the Memory Card .....	362
21.2.2 Playback over Network.....	368
21.2.3 Access to the Recorded Files through FTP Server.....	369
21.2.4 Playback of Daylight Saving Time Events .....	369



<b>Chapter 22 Advanced Applications..</b>	<b>371</b>
<b>22.1 Upgrading System Firmware.....</b>	<b>371</b>
22.1.1 Using the Web Configuration Interface .....	373
22.1.2 Using the IP Device Utility.....	374
<b>22.2 Backing Up and Restoring Settings .....</b>	<b>376</b>
<b>22.3 Restoring to Factory Default Settings.....</b>	<b>378</b>
<b>22.4 Verifying Watermark .....</b>	<b>390</b>
22.4.1 Accessing AVI Files .....	390
22.4.2 Running Watermark Proof.....	391
22.4.3 The Watermark Proof Window .....	392
<b>22.5 Downloading Videos from the Micro SD Card.....</b>	<b>393</b>
22.5.1 Installing the GV-SDCardSync Utility .....	394
22.5.2 The GV-SDCardSync Utility Window .....	398
<b>Chapter 23 DVR Configurations .....</b>	<b>400</b>
<b>23.1 Setting up an IP Camera .....</b>	<b>407</b>
23.1.1 Customizing IP Camera Settings .....	410
<b>23.2 Remote Monitoring with Multi View .....</b>	<b>412</b>
23.2.1 Connecting to the IP Camera.....	412
<b>23.3 Remote Monitoring with E-Map.....</b>	<b>413</b>
23.3.1 Creating an E-Map for the IP Camera.....	413
23.3.2 Connecting to the IP Camera.....	415
<b>Chapter 24 CMS Configurations.....</b>	<b>416</b>
<b>24.1 Center V2.....</b>	<b>416</b>
<b>24.2 VSM.....</b>	<b>419</b>
<b>24.3 Dispatch Server .....</b>	<b>420</b>
<b>Chapter 25 Smart Device Connection .....</b>	<b>422</b>
<b>Appendix.....</b>	<b>423</b>

A. Settings for Internet Explorer 8 .....	423
B. Supported Lenses for Box Camera.....	424
C. Resolution and Frame Rate .....	425
D. Support Lists.....	431
E. RTSP Protocol Command .....	437
F. The CGI Command.....	438
G. Dual Stream Support List .....	440
H. Power Supply Support List.....	443
I. Supported Firmware for Flash Memory .....	444
<b>Specifications.....</b>	<b>445</b>
Specifications: Box Camera (Part 1) .....	445
Specifications: Box Camera (Part 2) .....	455
Specifications: Ultra Box Camera.....	469
Specifications: Target Box Camera.....	475
Specifications: IR Arctic Box Camera .....	479
Specifications: Mini Fixed Dome (Part 1).....	490
Specifications: Mini Fixed Dome (Part 2).....	497
Specifications: Mini Fixed Rugged Dome .....	506
Specifications: Target Mini Fixed Dome .....	517
Specifications: Bullet Camera (Part 1) .....	521
Specifications: Bullet Camera (Part 2) .....	532
Specifications: Ultra Bullet Camera .....	541
Specifications: Target Bullet Camera.....	552
Specifications: PTZ Camera.....	556
Specifications: PT Camera .....	561
Specifications: Vandal Proof IP Dome (Part 1).....	567
Specifications: Vandal Proof IP Dome (Part 2).....	579
Specifications: Fixed IP Dome (Part 1).....	592
Specifications: Fixed IP Dome (Part 2).....	598
Specifications: Cube Camera.....	610
Specifications: Advanced Cube Camera .....	615

## Naming and Definition

<b>GV-System</b>	GeoVision Analog and Digital Video Recording Software. The GV-System also refers to <b>GV-Multicam System</b> , <b>GV-NVR System</b> , <b>GV-DVR System</b> and <b>GV-Hybrid DVR System</b> at the same time.
------------------	---

## Options

Optional devices can expand your camera's capabilities and versatility. Contact your dealer for more information.

Device	Description
Power Adapter	<p>The power adapter is available for all GV-IP Camera (except Arctic Box Camera and Mini Fixed Rugged Dome). The supported regions are listed below:</p> <ul style="list-style-type: none"> <li>• GV-BL Series (except GV-BL2500 / 2510), GV-BX Series (except GV-BX2500), GV-CB/CBW Series, GV-CA/CAW Series, GV-FD Series (except GV-FD1500 / 1510 / 2500 / 2510), GV-PT, GV-PTZ, GV-UBL Series (except GV-UBL2511), GV-UBX Series and GV-VD120D / 121D / 122D / 123D / 220D / 221D / 222D / 223D / 320D / 321D / 322D / 323D / 2400 / 3400 (except GV-VD1500 / 2500), Target Series: Australia, Europe, U.K, U.S.A</li> <li>• GV-BL2500 / 2510, GV-BX2500, GV-FD1500 / 1510 / 2500 / 2510, GV-MFD Series, GV-UBL2511 and GV-VD1500 / 2500: Australia, Brazil, Europe, U.K, U.S.</li> <li>• GV-VD1530 / 1540 / 1540-E / 2430 / 2440 / 2440-E / 2530 / 2540 / 2540-E / 3430 / 3440 / 3440-E / 5340 / 5340-E: Argentina, Australia, Brazil, Europe, U.K and U.S. Note that power cord is not supplied with the power adapter for these models.</li> </ul>

Device	Description
GV-PA191 PoE Adapter	The GV-PA191 PoE adapter is designed to provide power and network connection to the cameras over a single Ethernet cable.
GV-PA481 PoE Adapter	The GV-PA481 PoE adapter is designed to provide power and network connection to GV-BX1500-E / 2400-E / 3400-E / 5300-E over a single Ethernet cable.
GV-POE Switch	The GV-POE Switch is designed to provide power along with network connection for IP devices. The GV-POE Switch is available in various models with different numbers and types of ports.
GV-Mount Accessories	The GV-Mount Accessories provide a comprehensive lineup of accessories for installation on ceiling, wall corner and pole. For details, see <i>GV-Mount Accessories Installation Guide</i> on the Software CD.
GV-WiFi Adapter	The GV-WiFi Adapter is a plug-and-play device designed to connect GV-BX1200 Series / 1300 series / 1500 series / 2400 series / 2500 series / 3400 series / 5300 series and GV-MFD1501 series / 2401 series / 2501 series / 3401 series / 5301 series to wireless network. This product complies with IEEE 802.11 b/g/n (Draft 3.0) standards for wireless networking.
GV-IR LED T2	A mountable infrared LED device that improves image performance of Box Cameras under low light conditions.
GV-Relay V2	The GV-Relay V2 is designed to expand the voltage load of GV IP devices. It provides 4 relay outputs, and each can be set as normally open (NO) or normally closed (NC) independently as per your requirement.

<b>Device</b>	<b>Description</b>
Smoked Cover	The smoked cover is an IK7, tinted camera cover designed for GV-Fixed IP Dome to conceal the direction of the camera lens.

## Note for Connecting to GV-System

The GV-IPCAM H.264 is designed to work with GV-System, a hybrid or digital video management system. Note the following when GV-IPCAM H.264 is connected to GV-System:

- 1 By default, the images are recorded to the memory card inserted in the **GV-IP Camera H.264** (except GV-IR Arctic Box Camera and Target Series, which are not equipped with a memory card slot).
- 2 Once the camera is connected to the GV-System, the resolution set on the GV-System will override the resolution set on the camera's Web interface. You can only change the resolution settings through the Web interface when the connection to the GV-System is interrupted.

## Note for Recording

- 1 By default, the images are recorded to the memory card inserted in the **GV-IP Camera H.264** (except GV-IR Arctic Box Camera and Target Series, which are not equipped with a memory card slot). Make sure the **Write recording data into local storage** option (see *20.1.1 Video Settings*) is enabled. If this option is disabled, the camera will stop recording to the memory card while the live view is accessed through Web browsers or other applications.
- 2 Mind the following when using a memory card for recording:
  - Recorded data on the memory card can be damaged or lost if the data are accessed while the camera is under physical shock, power interruption, memory card detachment or when the memory card reaches the end of its lifespan. No guarantee is provided for such causes.
  - To avoid power outage, it is highly suggested to apply a battery backup (UPS).
  - For better performance, it is highly suggested to use Micro SD card of MLC NAND flash, Class 10.
  - Replace the memory card when its read/write speed is lower than 6 MB/s or when the memory card is frequently undetected by the camera.



## Note for Adjusting Focus and Zoom

When adjusting the Focus and Zoom Screws (on Box Camera, IR Arctic Box Camera, Bullet Camera, Vandal Proof IP Dome and Fixed IP Camera), do not over tighten the Focus and Zoom screws. The screws only need to be as tight as your finger can do it. It is not necessary to use any tools to get them tighter. Doing so can damage the structure of lens.

For example,

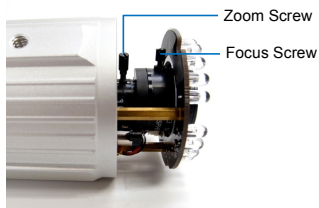

**Bullet Camera**

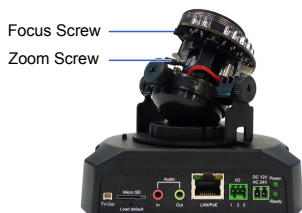

**Fixed IP Camera**

The maximum torque value for all the zoom and focus screws is 0.049 N.m

## Note for Installing Camera Outdoor

When installing the **IR Arctic Box Camera**, **Bullet Camera**, **Ultra Bullet Camera**, **Target Bullet Camera**, **Vandal Proof IP Dome** or **Mini Fixed Rugged Dome** outdoor, be sure that:

1. The camera is set up above the junction box to prevent water from entering the camera along the cables.

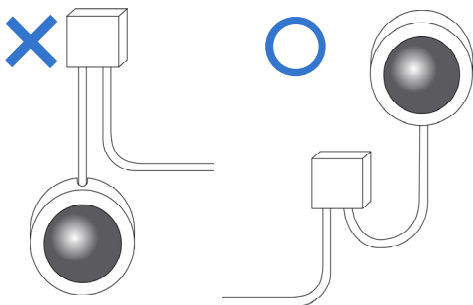

2. Any PoE, power, audio and I/O cables are waterproofed using waterproof silicon rubber or the like.

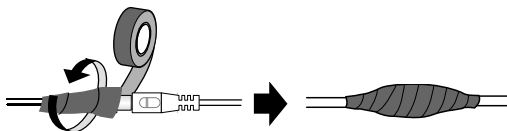

3. After opening the camera cover, ensure the screws are tightened and the cover is in place.

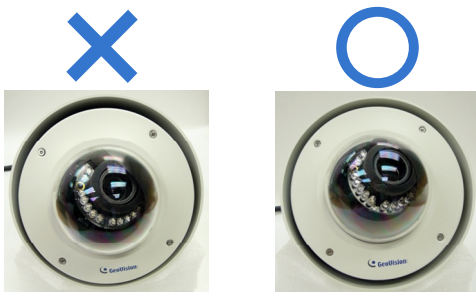

4. The silica gel bag loses its effectiveness when the dry camera is opened. To prevent the lens from fogging up, replace the silica gel bag every time you open the camera, and conceal the gel bag in camera within 2 minutes of exposing to open air.
5. For each newly replaced silica gel bag, allow it to absorb moisture for at least 5 hours before operating the camera.

## Note for Closing the Bullet Camera Cover

To ensure that the camera performs its full capacity against water and dust, adhere to the following guidelines when closing the Bullet Camera cover:

### 1. **Line up the dots**

Tighten the camera cover until the dots on the cover and the body line up as indicated below.



### 2. **Make your own marks**

For earlier models, you may not have dots on your camera. In this case, make your own marks on the camera cover and the body to note down the position.

## Note for USB Storage and WiFi Adapter

Mind the following limitations and requirements for using USB storage and GV-WiFi Adapter:

1. The USB hard drive must be of 2.5" or 3.5", version 2.0 or above.
2. The USB hard drive's storage capacity must not exceed 2TB.
3. USB flash drives and USB hubs are not supported.
4. External power supply is required for the USB hard drive.
5. To connect a GV-WiFi Adapter, make sure it is connected before the camera is powered on.

# Chapter 1 Introduction

The GV-IPCAM H.264 series offers a comprehensive range of IP cameras supporting your needs for IP surveillance in various environmental conditions. For detailed features of each model, refer to the corresponding chapter.

## 1.1 System Requirement

To perform the GV-IPCAM H.264 operations through Web browser, ensure your PC is in good network connection, and use one of the following web browsers:

- Microsoft Internet Explorer 7.x or later
- Google Chrome
- Mozilla Firefox
- Safari

---

### Note:

- 1 For the users of **Internet Explorer 8**, additional settings are required. For details, see *Appendix A*.
  - 2 With non-IE browsers,
    - A. Motion Detection, Tampering Alarm, Visual Automation, Text Overlay, two-way audio and GPS map settings are not supported.
    - B. only the Play function is available on the live view window (Figure 19-3)
    - C. RTSP streaming must be kept as enabled. For more detail, see *20.3.8 RTSP*.
-

## Chapter 2 Box Camera

The Box Camera is a series of indoor IP cameras consisting of fixed focal and varifocal models in different resolutions. The Box Camera supports lens replacement and features an automatic infrared-cut filter for day and night surveillance. The super low lux models are capable of displaying color live view in near darkness. Models equipped with a mini USB port can be connected wirelessly through a GV-WiFi Adapter (optional). The WDR Pro models can produce clear image for scenes with contrasting intensity of lights (see 2.2.1 *Wide Dynamic Range Pro* for details). For details on related models, see 2.2 *Features*. The Box Camera models are detailed below:

### Box Camera

Model No.		Specifications	Description
GV-BX120D	Varifocal Lens	Auto Iris, f:2.8 ~ 12 mm, F/1.4, 1/3" CS Lens	1.3 MP, H.264, Low Lux, D/N
GV-BX130D-0		Auto Iris, f: 2.8 ~ 12 mm, F/1.4, 1/3" CS Lens	1.3 MP, H.264, D/N
GV-BX130D-1	Fixed Lens	Fixed Iris, f: 4 mm, F/1.4, 1/3" CS Lens	1.3 MP, H.264, D/N
GV-BX140DW	Varifocal Lens	Fixed Iris, f: 2.8 ~ 12 mm, F/1.4, 1/3" CS Lens	1 MP, H.264, D/N, WDR Pro
GV-BX220D-2		Auto Iris, f: 2.8 ~ 6 mm, F/1.3, 1/3" CS Lens	2 MP, H.264, D/N

Model No.		Specifications	Description
GV-BX220D-3	Varifocal Lens	Auto Iris, f: 2.8 ~ 12 mm, F/1.4, 1/3" CS Lens	2 MP, H.264, D/N
GV-BX320D-0	Varifocal Lens	Auto Iris, f: 3.1 ~ 8 mm, F/1.2, 1/3" CS Lens	3 MP, H.264, D/N
GV-BX320D-1		Auto Iris, f: 2.8 ~ 6 mm, F/1.3, 1/3" CS Lens	
GV-BX520D		Manual Iris, f: 4.5 ~ 10 mm, F/1.6, 1/2" CS Lens	5 MP, H.264, D/N
GV-BX1200-0F	Fixed Lens	Fixed Iris, f: 4 mm, F/1.5, 1/3" CS Lens	1.3 MP, H.264, Low Lux, D/N
GV-BX1300-0F			1.3 MP, H.264, D/N
GV-BX1500-0F			1.3 MP, H.264, Super Low Lux, D/N
GV-BX2400-0F			2 MP, H.264, D/N, WDR Pro
GV-BX2500-0F			2 MP, H.264, Super Low Lux, D/N
GV-BX3400-0F			3 MP, H.264, D/N, WDR Pro



Model No.		Specifications	Description
GV-BX1200-1F	Fixed Lens	Fixed Iris, f: 8 mm, F/1.6, 1/2.5" CS Lens	1.3 MP, H.264, Low Lux, D/N
GV-BX1300-1F			1.3 MP, H.264, D/N
GV-BX1500-1F			1.3 MP, H.264, Super Low Lux, D/N
GV-BX2400-1F			2 MP, H.264, D/N, WDR Pro
GV-BX2500-1F			2 MP, H.264, Super Low Lux, D/N
GV-BX3400-1F			3 MP, H.264, D/N, WDR Pro
GV-BX1200-2F		Fixed Iris, f: 12 mm, F/1.6, 1/2.5" CS Lens	1.3 MP, H.264, Low Lux, D/N
GV-BX1300-2F			1.3 MP, H.264, D/N
GV-BX1500-2F			1.3 MP, H.264, Super Low Lux, D/N
GV-BX2400-2F			2 MP, H.264, D/N, WDR Pro
GV-BX2500-2F			2 MP, H.264, Super Low Lux, D/N
GV-BX3400-2F			3 MP, H.264, D/N, WDR Pro

Model No.		Specifications	Description
GV-BX1200-3V	Varifocal Lens	Auto Iris, f:2.8 ~ 12 mm, F/1.4, 1/2.7" CS Lens	1.3 MP, H.264, Low Lux, D/N
GV-BX1300-3V			1.3 MP, H.264, D/N
GV-BX1500-3V			1.3 MP, H.264, Super Low Lux, D/N
GV-BX2400-3V			2 MP, H.264, D/N, WDR Pro
GV-BX2500-3V			2 MP, H.264, Super Low Lux, D/N
GV-BX2400-4V		Auto Iris, f:3 ~ 10.5 mm, F/1.4, 1/2.7" CS Lens	2 MP, H.264, D/N, WDR Pro
GV-BX3400-4V		Auto Iris, f: 2.8 ~ 6 mm, F/1.3, 1/3" CS Lens	3 MP, H.264, D/N, WDR Pro
GV-BX3400-5V			
GV-BX5300-6V		Manual Iris, f: 4.5 ~ 10 mm, F/1.6, 1/2" CS Lens	5 MP, H.264, D/N
GV-BX1500-8F	Fixed Lens	Fixed Iris, f: 2.8 mm, F/1.8, 1/2.5" CS Lens	1.3 MP, H.264, Super Low Lux, D/N
GV-BX2400-8F			2 MP, H.264, D/N, WDR Pro
GV-BX2500-8F			2 MP, H.264, Super Low Lux, D/N
GV-BX3400-8F			3 MP, H.264, D/N, WDR Pro
GV-BX5300-8F			5 MP, H.264, D/N

## 2.1 Packing List

- Box Camera
- Terminal Block
- Fixed Focal or Varifocal Megapixel Lens
- Six Lens Rings
- One 0.125 mm Lens Ring (for GV-BX140DW only)
- Video Out Wire
- Camera Holder
- GV-IPCAM H.264 Software CD
- GV-IPCAM H.264 Quick Start Guide
- GV-NVR Software DVD
- GV-NVR Quick Start Guide

---

**Note:** Power adapter can be purchased upon request.

---

## 2.2 Features

- Image sensor

Camera Model	Image Sensor
GV-BX120D GV-BX1200 Series	1/3" progressive scan low lux CMOS
GV-BX130D Series GV-BX1300 Series GV-BX220D Series GV-BX320D Series GV-BX520D GV-BX5300 Series	1/2.5" progressive scan CMOS
GV-BX140DW	1/3" progressive scan CMOS
GV-BX1500 Series	1/3" progressive scan super low lux CMOS
GV-BX2500 Series	1/2.8" progressive scan super low lux CMOS
GV-BX2400 Series GV-BX3400 Series	1/3.2" progressive scan CMOS

- Dual streams from H.264 or MJPEG
- Day / Night function (with removable IR-cut filter)
- Wide Dynamic Range Pro  
(GV-BX140DW / 2400 Series / 2500 Series / 3400 Series only)
- Defog
- Two-way audio
- One sensor input and alarm output
- TV-out support
- Micro SD card slot (SD/SDHC) for local storage
- Mini USB slot for WiFi Adapter or a USB hard drive (for GV-BX1200 Series / 1300 Series / 1500 Series / 2400 Series / 2500 Series / 3400 Series / 5300 Series only)

- Frame rate:

Camera Model	Frame Rate
GV-BX120D GV-BX130D Series GV-BX1200 Series GV-BX1300 Series GV-BX1500 Series	Up to 30 fps at 1280 x 1024
GV-BX140DW	Up to 30 fps at 1280 x 720
GV-BX220D Series GV-BX2400 Series GV-BX2500 Series	Up to 30 fps at 1920 x 1080
GV-BX320D Series GV-BX3400 Series	Up to 20 fps at 2048 x 1536
GV-BX520D GV-BX5300 Series	Up to 10 fps at 2560 x 1920

- Motion detection
- Tampering alarm
- Visual automation
- Privacy mask
- Text overlay
- IP address filtering
- Power supply: DC 12V and PoE
- Megapixel lens
- Support for iPhone, iPad, Android and 3GPP
- 31 languages on Web interface
- ONVIF (Profile S) conformant

## 2.2.1 Wide Dynamic Range Pro

Objects may appear as silhouettes when they are backed with intense lights. The Wide Dynamic Range Pro (WDR Pro) is designed to solve this problem using a WDR sensor. In **GV-BX140DW**, **GV-BX2400 Series** and **GV-BX3400 Series**, the WDR sensor is able to process the image and show details in bright and dark areas at the same time. An example of WDR Pro in action is shown below.

**No WDR:** underexposure



**WDR:** perfect exposure



For GV-IPCam H.264 models that support WDR, the WDR effect is achieved through software programming.

## 2.3 Overview

### 2.3.1 GV-BX120D / 130D Series / 140DW / 220D Series / 320D Series / 520D

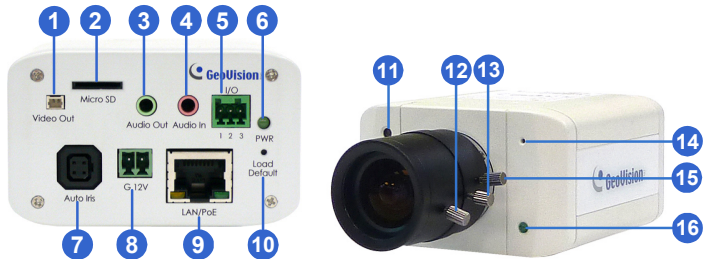

Figure 2-1

---

#### Note:

1. The Auto Iris connector (No. 7) is only functional in GV-BX120D, GV-BX130D-0, GV-BX220D and GV-BX320D.
  2. The Light Sensor (No.11) is only available in GV-BX140DW. Keep the Light Sensor unobscured for accurate light detection.
  3. The Iris Screw (No.13) is only available for GV-BX520D.
  4. The Zoom Screw (No. 15) is not available for GV-BX130D-1.
- 

No.	Name	Description
1	Video Out	Connects to a portable monitor for setting the focus and angle of Box Camera during initial installation.
2	Memory Card Slot	Inserts a micro SD card (SD/SDHC, version 2.0 only, Class 10) to store recording data.

No.	Name	Description
3	Audio Out	Connects a speaker for audio output.
4	Audio In	Connects a microphone for audio input.
5	I/O Terminal Block	For details, see 2.6 <i>I/O Terminal Block</i> .
6	Power LED	Indicates the power is supplied. For detail, see the table below.
7	Auto Iris Connector	Plug the iris control cable to the connector.
8	DC 12V Port	Connects to power.
9	LAN / PoE	Connects to a 10/100 Ethernet or PoE.
10	Default	Resets all configurations of the GV-IPCAM H.264 to the default factory settings. See 22.3 <i>Restoring to Factory Default Settings</i> .
11	Light Sensor	Detects light to switch between day and night mode.
12	Focus Screw	Adjusts the focus of the camera.
13	Iris Screw	Adjusts the iris of the camera.
14	Microphone	Records the sounds.
15	Zoom Screw	Adjusts the zoom of the camera.
16	Status LED	Turns on when the unit is ready for use. For detail, see the table below.

LED	Description
Power LED turns green	The system powers on and succeeds to boot up.
Status LED turns green	The system is ready for use.



## 2.3.2 GV-BX1200 Series / 1300 Series / 1500 Series / 2400 Series / 2500 Series / 3400 Series / 5300 Series

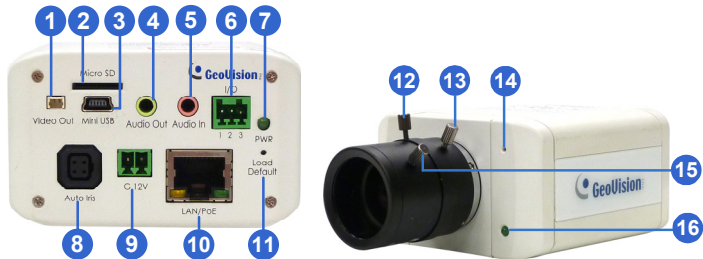

Figure 2-2

---

### Note:

1. The Auto Iris Connector (No. 8) is only functional for varifocal models of GV-BX1200 / 1300 / 1500 / 2400 / 2500 / 3400.
  2. The Iris Screw (No. 12) is only available in GV-BX5300-6V.
  3. The Zoom Screw (No. 13) is only available for varifocal models of GV-BX1200 / 1300 / 1500 / 2400 / 2500 / 3400 / 5300.
- 

No.	Name	Description
1	Video Out	Connects to a portable monitor for setting the focus and angle of Box Camera during initial installation.
2	Memory Card Slot	Inserts a micro SD card (SD/SDHC, version 2.0 only, Class 10) to store recording data.
3	Mini USB Slot	Connects to a GV-WiFi Adapter or a USB hard drive.

No.	Name	Description
4	Audio Out	Connects a speaker for audio output.
5	Audio In	Connects a microphone for audio input.
6	I/O Terminal Block	Connects to I/O devices. For details, see 2.6 <i>I/O Terminal Block</i> .
7	Power LED	Indicates the power is supplied. For detail, see the table below.
8	Auto Iris Connector	Plug the iris control cable to the connector.
9	DC 12V Port	Connects to power.
10	LAN / PoE	Connects to a 10/100 Ethernet or PoE.
11	Default	Resets all configurations of the GV-IPCAM H.264 to the default factory settings. See 22.3 <i>Restoring to Factory Default Settings</i> .
12	Iris Screw	Adjusts the iris of the camera.
13	Zoom Screw	Adjusts the zoom of the camera.
14	Microphone	Records the sounds.
15	Focus Screw	Adjusts the focus of the camera.
16	Status LED	Turns on when the unit is ready for use. For detail, see the table below.

LED	Description
Power LED turns green	The system powers on and succeeds to boot up.
Status LED turns green	The system is ready for use.

## 2.4 Connecting the Camera

The Box Camera is designed for indoor use. Please make sure the installing site is shielded from rain and moisture.

### 2.4.1 GV-BX120D / 130D Series / 140DW / 220D Series / 320D Series / 520D

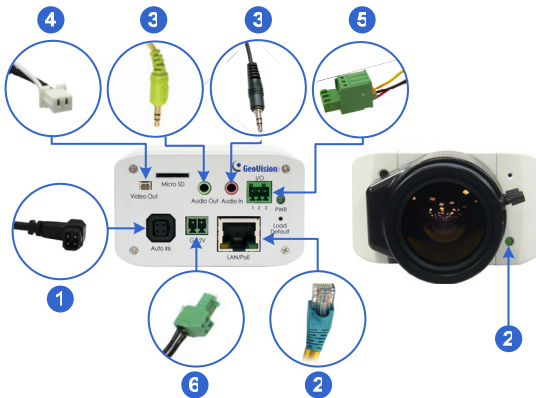

Figure 2-3

1. If you are using an auto iris model, plug the iris control cable to the Auto Iris Connector on the camera.
2. Use a standard network cable to connect the camera to your network.
3. Optionally connect a speaker and an external microphone.
4. Optionally connect a monitor using a Video Out wire. Enable this function by selecting your signal format at the **TV Out** field on the Web interface. See *20.1.1 Video Settings*.
5. Optionally connect to input / output devices or an infrared illuminator. For details, see *2.5.2 Infrared Illuminator* and *2.6 I/O Terminal Block*.

6. Connect power using one of the following methods:
  - plugging the power adapter to the power port.
  - using the Power over Ethernet (PoE) function and the power will be provided over the network cable.
7. The status LED of the camera will be on.
8. You are ready to access the live view, adjust the image clarity and configure the basics. See *Getting Started, Chapter 18*.

## 2.4.2 GV-BX1200 Series / 1300 Series / 1500 Series / 2400 Series / 2500 Series / 3400 Series / 5300 Series

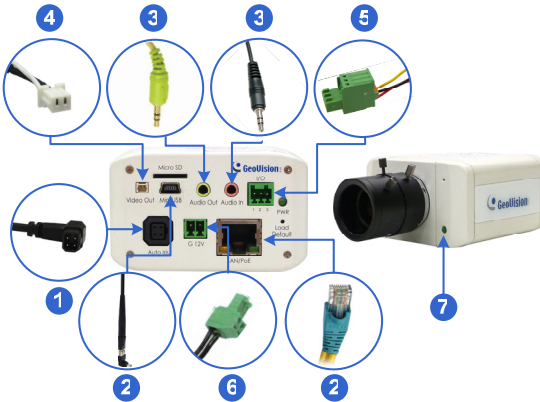

Figure 2-4

1. If you are using an auto iris model, plug the iris control cable to the Auto Iris Connector on the camera.
2. Connect to network using one of the following methods:
  - **Wired Connection:** Use a standard network cable to connect the camera to your network and optionally connect a USB hard drive to the mini USB port.
  - **Wireless Connection:** Connect a GV-WiFi Adapter (optional accessory).
3. Optionally connect a speaker and an external microphone.
4. Optionally connect a monitor using a Video Out wire. Enable this function by selecting your signal format at the TV Out field on the Web interface. See *20.1.1 Video Settings*.

5. Optionally connect to input / output devices or an infrared illuminator. For details, see *2.5.2 Infrared Illuminator* and *2.6 I/O Terminal Block*.
6. Connect power using one of the following methods:
  - plugging the power adapter to the power port. The power adapter is an optional device. For detail, see *Options* in the manual.
  - using the Power over Ethernet (PoE) function and the power will be provided over the network cable.
7. The status LED of the camera will be on.
8. You are ready to access the live view, adjust the image clarity and configure the basics. See *Getting Started*, Chapter 18.

---

**Note:** For details on limitations and requirements of the mini USB port, refer to the *Note for USB Storage and WiFi Adapter* at the beginning of this manual.

---

## 2.5 Accessory Installation

### 2.5.1 C-Mount Lenses

If you use a C-mount lens, it requires a certain distance from the camera's imaging chip to focus the lens. Mount the supplied C-mount lens adapter / lens ring to the camera, and then secure the lens onto the camera body.

Three types of C-mount lens rings are provided for Box Camera:

- 0.188 mm (transparent color) x 2
- 0.125 mm (black color with a glossy surface) x 2
- 0.254 mm (black color with a matt surface) x 2

For GV-BX140DW, a 0.125 mm is provided.

---

**Note:** The C-mount lens rings are specially designed for Box Camera. Besides the supplied C-mount lens rings, each of these models has already included with the necessary lens ring.

---



Figure 2-5

## 2.5.2 Infrared Illuminators (Optional)

If you use an infrared (IR) illuminator with I/O function, follow the steps below to install it.

1. Connect the infrared illuminator to the terminal block on the camera.  
See *2.6 The I/O Terminal Block*.
2. Access the Web interface of the camera.
3. Select **Video and Motion**, select **Video Settings**, select **Streaming 1** and set the **IR Check Function** option to be **Trigger by Input** or **Trigger IR by D/N**.
4. Click **Apply**.

For the **Trigger by Input** or **Trigger IR by D/N** function and D/N sensitivity settings, see *20.1.1 Video Settings*.



## 2.6 I/O Terminal Block

The terminal block, located on the back panel of the Box Camera, provides the interface to one input and one output devices. The I/O terminal block can be used for applications such as motion detection, event alerts via E-Mail and FTP, and center monitoring through Center V2 and VSM.

### 2.6.1 Pin Assignment

The pin assignment for the I/O terminal block:

For the output point, please check if your output device meets the following **Absolute Maximum Ratings** before connecting it to the output point.

Breakdown Voltage	277V AC, 30V DC
Continuous Load Current	5A (NO), 3A (NC)
<p><b>Note:</b> Absolute Maximum Ratings are those values beyond which damage to the camera may occur. Continuous operation of the camera at the absolute rating level may affect the camera reliability.</p>	

The Box Camera support one digital input and one digital output of dry contact.

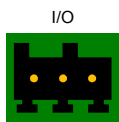

1 2 3  
Figure 2-6

Pin	Function
1	Digital Input
2	GND
3	Digital Output

For details on how to enable an installed I/O device, see [20.2 I/O Settings](#).

## 2.6.2 Connecting to GV-Relay V2 (Optional)

The Box Camera can only drive a maximum load of **200mA 5V DC**. To expand the maximum voltage load to **10A 250V AC**, **10A 125V AC** or **5A 100V DC**, connect the camera to a GV-Relay V2 module (optional product). Refer to the figure and table below.

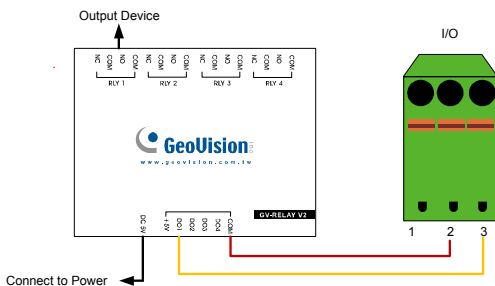

Figure 2-7

GV-Relay V2	I/O Terminal Block
COM	Pin 2 (GND)
DO1	Pin 3 (Digital Output)

## Chapter 3 Ultra Box Camera

The Ultra Box Camera is a series of light-weighted cameras designed for indoor usage. Equipped with IR-cut filter and built-in IR LEDs, the Ultra Box Camera provides excellent image quality. The camera supports PoE and can be installed intuitively. Nine models of varying resolutions and focal lengths are available.

Model No.		Specifications	Description
GV-UBX1301-0F GV-UBX1301-1F GV-UBX1301-2F	Fixed Lens	Fixed Iris, f: 3 / 4 / 8 mm, F/1.6, 1/3" M12 Mount	1.3 MP, H.264, D/N
GV-UBX2301-0F GV-UBX2301-1F GV-UBX2301-2F			2 MP, H.264, D/N
GV-UBX3301-0F GV-UBX3301-1F GV-UBX3301-2F			3 MP, H.264, D/N

## 3.1 Packing List

- Ultra Box Camera
- Supporting rack
- Screw x 3
- Screw anchor x 3
- GV-IPCAM H.264 Software CD
- GV-IPCAM H.264 Quick Start Guide
- GV-NVR Software DVD
- GV-NVR Quick Start Guide

---

**Note:** Power adapter can be purchased upon request.

---

## 3.2 Features

- 1/2.5" progressive scan CMOS
- Dual streams from H.264 or MJPEG
- Frame rate

Camera Model	Frame Rate
GV-UBX1301 Series	Up to 30 fps at 1280 x 1024
GV-UBX2301 Series	Up to 30 fps at 1920 x 1080
GV-UBX3301 Series	Up to 20 fps at 2048 x 1536



- Intelligent IR
- Day and night function (with removable IR-cut filter)
- Wide Dynamic Range (WDR)
- Defog
- Micro SD card slot (SD/SDHC) for local storage
- Two-way audio
- Motion detection
- Tampering alarm
- Text overlay
- Privacy mask
- IP address filtering
- DC 5V / PoE
- Megapixel lens
- Support for iPhone, iPad, Android and 3GPP
- 31 languages on Web interface
- ONVIF (Profile S) conformant

### 3.3 Overview



Figure 3-1

No.	Name	Description
1	Audio Out	Connects a speaker for audio output.
2	Default	Resets the camera to factory defaults. See 22.3 <i>Restoring to Factory Default Settings</i> .
3	LAN / PoE	Connects to a 10/100 Ethernet or PoE.
4	Microphone	Records sounds.
5	Memory Card Slot	Inserts a micro SD card (SD/SDHC, version 2.0 only, Class 10) to store recording data.
6	DC 5V Terminal Block	Connects to power.

LED Indicator	Description
 Status LED	The status LED turns on (green) when the system is ready for use.
 Power LED	The power LED turns on (green) when power is supplied to the camera.

## 3.4 Installation

You can stand the Ultra Box Camera on a plain surface or install it to wall and ceiling. Follow the steps below to install, connect and adjust your Ultra Box Camera.

1. To install the device on the wall/ceiling, put the supporting rack on the desired location and make marks for screw anchors.



*Figure 3-2*

2. Drill the marks and insert the screw anchors.
3. Secure the supporting rack onto the wall/ceiling using the supplied screws.
4. Secure the camera onto the supporting rack and fasten the indicated screw.



*Figure 3-3*

5. Connect the network and power cables to the camera. See 3.5 *Connecting the Camera*.
6. Access the live view. See 18.1 *Accessing the Live View*.
7. Adjust the angle of the camera based on live view and fasten the indicated screw.



*Figure 3-4*



### 3.5 Connecting the Camera



Figure 3-5

1. Connect power using one of the following methods:
  - Plug the power adapter to the 5V terminal block. The power adapter is an optional device. For detail, see *Options* in the manual.
  - Use the Power over Ethernet (PoE) function and the power will be provided over the network cable.

The power and status LEDs shall turn on (green).

2. Use a standard network cable to connect the camera to your network.
3. Optionally connect a speaker.
4. Insert a micro SD card (SD/SDHC, version 2.0 only, Class 10).
5. You are ready to access the live view, adjust the image clarity and configure the basics. See *Getting Started, Chapter 18*.

## Chapter 4 Target Box Camera

The Target Box Camera (GV-EBX) is a series of light-weighted cameras designed for indoor usage. Equipped with IR-cut filter and built-in IR LEDs, the camera is an entry-level surveillance solution with all the essential features and excellent image quality. The camera supports PoE and can be installed intuitively.

Model No.		Specifications	Description
GV-EBX1100-0F GV-EBX1100-1F	Fixed Lens	Fixed Iris, f: 2.8 / 3.8 mm, F/1.8, 1/2.7" M12 Mount	1.3 MP, H.264, Low Lux, D/N

### 4.1 Packing List

- Target Box Camera
- Supporting rack
- Screw x 3
- Screw anchor x 3
- GV-IPCAM H.264 Software CD
- GV-IPCAM H.264 Quick Start Guide
- GV-NVR Software DVD
- GV-NVR Quick Start Guide

---

**Note:** Power adapter can be purchased upon request.

---

## 4.2 Features

- 1/3" progressive scan low lux CMOS
- Dual streams from H.264 or MJPEG
- Up to 30 fps at 1280 x 1024
- Intelligent IR
- Day and night function (with removable IR-cut filter)
- Built-in microphone
- Wide Dynamic Range (WDR)
- Defog
- Motion detection
- Tampering alarm
- Text overlay
- Privacy mask
- IP address filtering
- DC 12V / PoE
- Megapixel lens
- Support for iPhone, iPad, Android and 3GPP
- 31 languages on Web interface
- ONVIF (Profile S) conformant

## 4.3 Overview

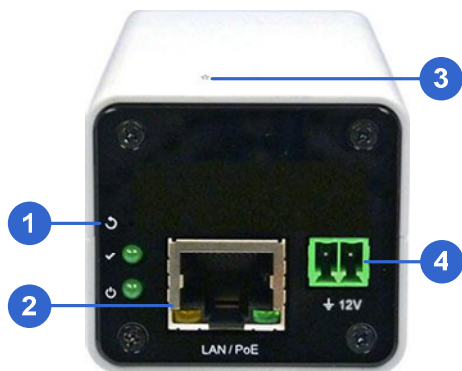



Figure 4-1

No.	Name	Description
1	Default	Resets the camera to factory defaults. See <i>22.3 Restoring to Factory Default Settings</i> .
2	LAN / PoE	Connects to a 10/100 Ethernet or PoE.
3	Microphone	Records sounds.
4	DC 12V Terminal Block	Connects to power.

LED Indicator	Description
 Status LED	The status LED turns on (green) when the system is ready for use.
 Power LED	The power LED turns on (green) when power is supplied to the camera.

## 4.4 Installation

You can stand the Target Box Camera on a plain surface or install it to wall and ceiling. Follow the steps below to install, connect and adjust your Target Box Camera.

1. To install the device on the wall/ceiling, put the supporting rack on the desired location and make marks for screw anchors.



Figure 4-2

2. Drill the marks and insert the screw anchors.
3. Secure the supporting rack onto the wall/ceiling using the supplied screws.
4. Secure the camera onto the supporting rack and fasten the indicated screw.



Figure 4-3

5. Connect the network and power cables to the camera. See 4.5 *Connecting the Camera*.
6. Access the live view. See 18.1 *Accessing the Live View*.
7. Adjust the angle of the camera based on live view and fasten the indicated screw.



*Figure 4-4*

## 4.5 Connecting the Camera

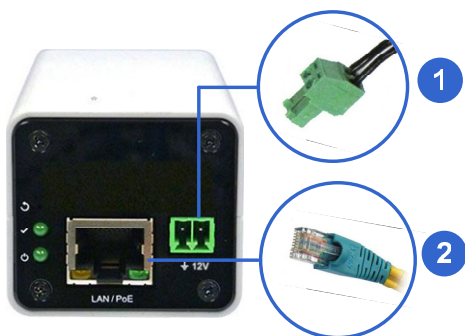

Figure 4-5

1. Connect power using one of the following methods:
  - Plug the power adapter to the 12V terminal block. The power adapter is an optional device. For detail, see *Options* in the manual.
  - Use the Power over Ethernet (PoE) function and the power will be provided over the network cable.

The power and status LEDs shall turn on (green).

2. Use a standard network cable to connect the camera to your network.
3. You are ready to access the live view, adjust the image clarity and configure the basics. See *Getting Started, Chapter 18*.

## Chapter 5 IR Arctic Box Camera

The IR Arctic Box Camera is a series of outdoor cameras designed for environments of extreme temperatures. The cameras adhere to IP67 and IK10 protection standards, and are equipped with IR LEDs and removable IR-cut filter for day and night surveillance. The GV-BX2400-E / 3400-E are equipped with WDR Pro to produce clear image for scenes containing contrasting intensity of lights (see 2.2.1 *Wide Dynamic Range Pro* for details).

### IR Arctic Box Camera

Model No.		Specifications	Description
GV-BX120D-E	Varifocal Lens	Auto Iris, f: 2.8 ~ 12 mm, F/1.4, 1/3" CS Lens	1.3 MP, H.264, Low Lux, D/N
GV-BX220D-E		Auto Iris, f: 2.8 ~ 6 mm, F/1.3, 1/3" CS Lens	2 MP, H.264, D/N
GV-BX320D-E		Auto Iris, f: 2.8 ~ 6 mm, F/1.3, 1/3" CS Lens	3 MP, H.264, D/N
GV-BX520D-E		Manual Iris, f: 4.5 ~ 10 mm, F/1.6, 1/2" CS Lens	5 MP, H.264, D/N
GV-BX1500-E		Auto Iris, f: 3 ~ 10.5 mm, F/1.4, 1/2.7" CS Lens	1.3 MP, H.264, Super Low Lux, D/N
GV-BX2400-E GV-BX3400-E		Auto Iris, f: 3 ~ 10.5 mm, F/1.4, 1/2.7" CS Lens	2 MP / 3 MP, H.264, D/N, WDR Pro
GV-BX5300-E		Manual Iris, f: 4.5 ~ 10 mm, F/1.6, 1/2" CS Lens	5 MP, H.264 D/N



## 5.1 Packing List

- IR Arctic Box Camera
- Screw Anchor x 4
- Screw x 4
- Washer x 4
- Big Torx Wrench
- Small Torx Wrench
- Silica Gel Bag x 2
- GV-IPCAM H.264 Software CD
- GV-IPCAM H.264 Quick Start Guide
- GV-NVR Software DVD
- GV-NVR Quick Start Guide

---

**Note:** You can optionally purchase the GV-PA481 PoE Adapter for GV-BX1500-E / 2400-E / 3400-E / 5300-E.

---

## 5.2 Features

- Image sensor

Camera Model	Image Sensor
GV-BX120D-E	1/3" progressive scan low lux CMOS
GV-BX1500-E	1/3" progressive scan super low lux CMOS
GV-BX220D-E GV-BX320D-E GV-BX520D-E GV-BX5300-E	1/3.2" progressive scan CMOS
GV-BX2400-E GV-BX3400-E	1/2.5" progressive scan CMOS

- Dual streams from H.264 or MJPEG
- Frame rate:

Camera Model	Frame Rate
GV-BX120D-E GV-BX1500-E	Up to 30 fps at 1280 x 1024
GV-BX220D-E GV-BX2400-E	Up to 30 fps at 1920 x 1080
GV-BX320D-E GV-BX3400-E	Up to 20 fps at 2048 x 1536
GV-BX520D-E GV-BX5300-E	Up to 10 fps at 2560 x 1920

- Day / Night function (with removable IR-cut filter)
- Wide Dynamic Range Pro (for GV-BX2400-E / 3400-E only)
- Defog
- Ingress protection (IP67)
- Vandal resistance (IK10 for metal casing)
- Built-in heater and fan
- Support for TV-out
- Two-way audio

- Motion detection
- Tampering alarm
- Privacy mask
- Text overlay
- IP address filtering
- Power supplied through PoE (IEEE 802.3at)
- Megapixel lens
- Support for iPhone, iPad, Android and 3GPP
- 31 languages on Web interface
- ONVIF (Profile S) conformant

## 5.3 Overview

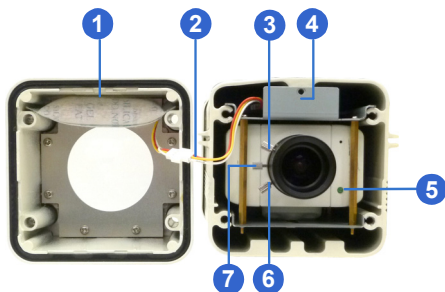

Figure 5-1

---

**Note:** The Iris Screw (No. 7) is only available in GV-BX520D-E and GV-BX5300-E.

---

No.	Name	Description
1	Silica gel bag	Desiccant that keeps the camera housing dry.
2	IR power plug	Supplies power to the built-in IR LEDs.
3	Focus Screw	Adjusts the focus of the camera.
4	Module screw	Holds the module in place.
5	Status LED	Turns on when the unit is ready for use.
6	Zoom Screw	Adjusts the zoom of the camera.
7	Iris Screw	Adjusts the iris of the camera.

## 5.4 Installation

The IR Arctic Box Camera is designed for outdoor use.

1. Mark the installation site and drill four holes for screw anchors.
2. Insert the supplied screw anchors.
3. Secure the camera to the wall using the supplied washers and screws.

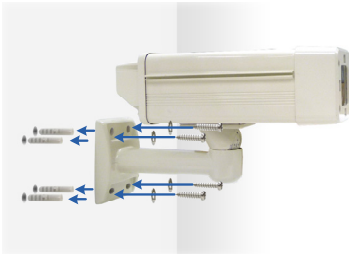

*Figure 5-2*

4. Connect the camera to the network and supply power via the PoE cable. See *5.5 Connecting the Camera*.
5. Access the live view. See *18.1 Accessing the Live View*.
6. Based on the live view, adjust the angle of the camera. Loosen the indicated screw with the supplied big torx wrench and adjust the joint.



*Figure 5-3*

### Tilt Adjustment



Figure 5-4

### Pan Adjustment



Figure 5-5

7. Based on the live view, adjust the focus, zoom and iris (in GV-BX520D-E and GV-BX5300-E only) of the camera.  
Unscrew the cover with the supplied small torx wrench.

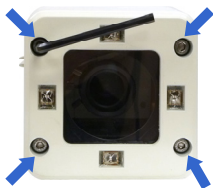
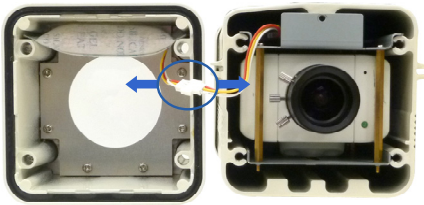

Figure 5-6

Hold the connectors and unplug them.



*Figure 5-7*

---

**IMPORTANT:** Unscrew and remove the cover carefully. Pulling the cover off may cause damages to the inner wiring of the camera.

---

Adjust the focus, zoom and iris screws.

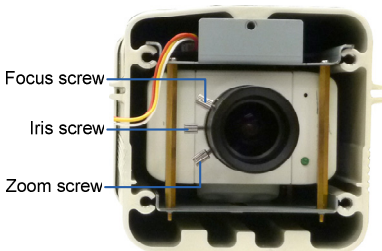

*Figure 5-8*

8. Replace the silica gel bag. Paste the sticker to the front side of the silica gel bag. Press the sticker several times to make sure it adheres properly. Paste the silica gel bag to the indicated place.

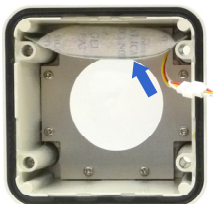

*Figure 5-9*

---

**IMPORTANT:**

1. The gel bag loses its effectiveness when the dry camera is opened. To prevent the lens from fogging up, replace the silica gel bag every time you open the camera, and conceal the silica gel bag in the camera within 2 minutes of exposing to open air.
  2. Allow the silica gel bag to absorb moisture for at least 5 hours before operating the camera.
- 

9. Refer to step 7 to plug the connectors and secure the camera cover.



## 5.5 Connecting the Camera

### 5.5.1 Wire Definition

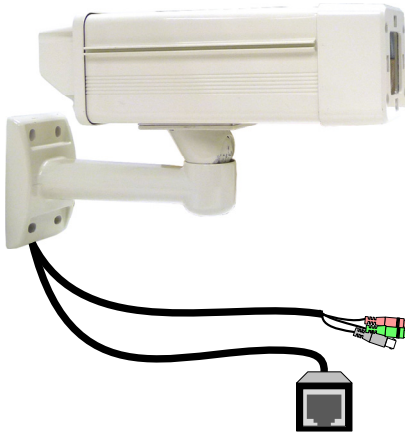

Figure 5-10

No.	Wire Color	Definition
1	Black (thick)	PoE
2	Black BNC	TV out
3	Green RCA	Audio Out
4	Pink RCA	Audio In

1. Optionally connect a speaker (green) and an external microphone (pink).
2. Optionally connect a monitor using a Video Out wire. Enable this function by selecting your signal format at the **TV Out** field on the Web interface. See *20.1.1 Video Settings*.

- Optionally connect the camera's cable to the GV-PA481 PoE adapter as illustrated below. The power and network will be supplied simultaneously.

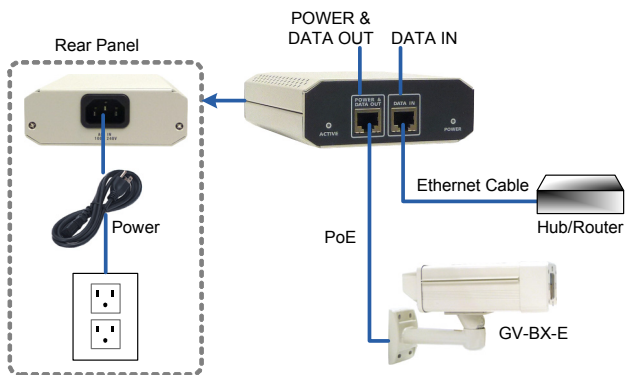

Figure 5-11

- The status LED of the camera will be on.
- You are ready to access the live view, adjust the image clarity and configure the basics. See *Getting Started*, Chapter 18.

## 5.6 Notice for Using the IR Arctic Box Camera

Ensure that you:

- enable IR LED function on the Web interface after loading the default settings.
- disable the status LED to reduce reflection when a green light spot appears on the live view.

### 5.6.1 Enabling IR LED after Loading Default

Each GV-IR Arctic Box Camera is equipped with 4 IR LEDs to provide infrared illumination at night. The factory-loaded setting for the IR LED function is **enabled**. If you have restored the camera to default settings, please follow the steps below to enable the IR LED function.

1. In the left menu of Web interface, select **Video Settings** and then **Streaming 1**.
2. Enable **Trigger IR by D/N** in IR Check Function.

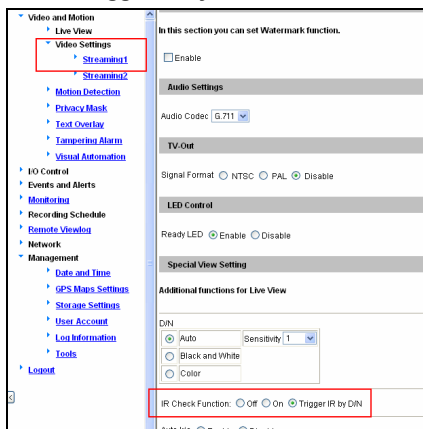

Figure 5-12

3. Click **Apply**.

## 5.6.2 Disabling Status LED under Low Light Conditions

If you have a green light spot on the live view, this is likely due to insufficient light at the installation site, which causes the status LED to reflect on the camera cover. In this case, it is advisable that you disable the status LED.

1. In the left menu of Web interface, select **Video Settings** and then **Streaming 1**.
2. Select **Disable** in LED Control.

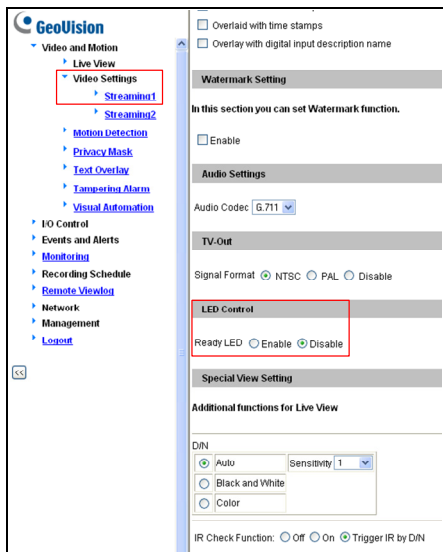

Figure 5-13

3. Click **Apply**.

## Chapter 6 Mini Fixed Dome & Mini Fixed Rugged Dome

The Mini Fixed Dome (GV-MFD) and Mini Fixed Rugged Dome (GV-MDR) are fixed, mini-sized ceiling-mount network cameras.

The GV-MDR series is designed for outdoor surveillance, conforming to IK10 and IP67 standards. The camera is adjustable in 3 axis (pan, tilt and rotate) and can be connected through PoE.

The GV-MFD series is designed for indoor surveillance. Adjustable in 2 axis (pan and tilt), the camera also supports PoE.

The super low lux models can provide color live view in near darkness and the WDR Pro models can process scenes of contrasting intensity of lights (see 2.2.1 *Wide Dynamic Range Pro* for details). For details on related models, see 6.2 *Features*.

## Mini Fixed Rugged Dome (GV-MDR)

Model No.	Specifications	Description
GV-MDR120	Fixed Iris, f: 4.05 mm, F/1.5, 1/3" M12 Mount	1.3 MP, H.264, Low Lux, Color
GV-MDR220 GV-MDR320 GV-MDR520	Fixed Iris, f: 2.54 mm, F/2.8, 1/2.5" M12 Mount	2 MP / 3 MP / 5MP, H.264, Color
GV-MDR1500-0F GV-MDR2400-0F GV-MDR2500-0F GV-MDR3400-0F	Fixed Iris, f: 2.1 mm, F/1.8, 1/3" M12 Mount	1.3 MP super low lux / 2 MP WDR Pro / 2 MP super low lux / 3 MP WDR Pro, H.264, Color
GV-MDR1500-1F GV-MDR2400-1F GV-MDR2500-1F GV-MDR3400-1F GV-MDR5300-1F	Fixed Iris, f: 2.8 mm, F/2.0, 1/3" M12 Mount	1.3 MP super low lux / 2 MP WDR Pro / 2 MP super low lux / 3 MP WDR Pro / 5 MP, H.264, Color
GV-MDR1500-2F GV-MDR2400-2F GV-MDR2500-2F GV-MDR3400-2F GV-MDR5300-2F	Fixed Iris, f: 3.8 mm, F/1.8, 1/3" M12 Mount	
GV-MDR1500-3F GV-MDR2400-3F GV-MDR2500-3F GV-MDR3400-3F GV-MDR5300-3F	Fixed Iris, f: 8 mm, F/1.6, 1/3" M12 Mount	
GV-MDR1500-4F GV-MDR2400-4F GV-MDR2500-4F GV-MDR3400-4F GV-MDR5300-4F	Fixed Iris, f: 12 mm, F/1.6, 1/3" M12 Mount	
Fixed Lens		

**Mini Fixed Dome (GV-MFD)**

Model No.		Specifications	Description
	GV-MFD120	Fixed Iris, f: 4 mm, F/1.5, 1/3" M12 Mount	1.3 MP Low Lux, H.264, Color
	GV-MFD130 GV-MFD220 GV-MFD320 GV-MFD520	Fixed Iris, f: 2.54 mm, F/2.8, 1/2.5" M12 Mount	1.3 MP / 2 MP / 3 MP / 5MP, H.264, Color
	GV-MFD1501-0F GV-MFD2401-0F GV-MFD2501-0F GV-MFD3401-0F GV-MFD5301-0F	Fixed Iris, f: 2.8 mm, F/2.0, 1/3" M12 Mount	1.3 MP Super Low Lux / 2 MP / 2 MP Super Low Lux / 3 MP / 5 MP, H.264, Color
	GV-MFD1501-1F GV-MFD2401-1F GV-MFD2501-1F GV-MFD3401-1F GV-MFD5301-1F	Fixed Iris, f: 4 mm, F/1.5, 1/3" M12 Mount	
	GV-MFD1501-2F GV-MFD2401-2F GV-MFD2501-2F GV-MFD3401-2F GV-MFD5301-2F	Fixed Iris, f: 8 mm, F/1.6, 1/3" M12 Mount	
	GV-MFD1501-3F GV-MFD2401-3F GV-MFD2501-3F GV-MFD3401-3F GV-MFD5301-3F	Fixed Iris, f: 12 mm, F/1.6, 1/3" M12 Mount	
	GV-MFD1501-4F GV-MFD2401-4F GV-MFD2501-4F GV-MFD3401-4F	Fixed Iris, f: 2.1 mm, F/1.8, 1/3" M12 Mount	
	Fixed Lens		

## 6.1 Packing List

- Mini Fixed Dome or Mini Fixed Rugged Dome with 3 options for its LAN connector (M12, Waterproof or Non-Waterproof)
- Torx Wrench
- Self Tapping Screw x 2
- Screw Anchor x 2
- Cable stopper
- 2-pin terminal block (for GV-MFD120 / 130 / 220 / 320 / 520)
- Short-Body RJ-45 Plug (for GV-MFD1501 series / 2401 series / 2501 series / 3401 series / 5301 series)
- USB / Audio Y-cable (for GV-MFD1501 series / 2401 series / 2501 series / 3401 series / 5301 series)
- Cable Connector (for GV-MDR series only)
- Installation sticker (for GV-MDR series only)
- Silica gel bag x 2 (for GV-MDR series only)
- Ferrite core for vehicle installation (for GV-MDR series only)
- GV-IPCAM H.264 Software CD
- GV-IPCAM H.264 Quick Start Guide
- GV-NVR Software DVD
- GV-NVR Quick Start Guide

---

**Note:** Power adapter can be purchased for Mini Fixed Dome upon request.

---



## 6.2 Features

- Image sensor

### GV-MFD

Camera Model	Image Sensor
GV-MFD120	1/3" progressive scan low lux CMOS
GV-MFD130 GV-MFD220 GV-MFD320 GV-MFD520	1/2.5" progressive scan CMOS
GV-MFD1501 series	1/3" progressive scan super low lux CMOS
GV-MFD2501 series	1/2.8" progressive scan super low lux CMOS
GV-MFD2401 series GV-MFD3401 series	1/3.2" progressive scan CMOS
GV-MFD5301 series	1/2.5" progressive scan CMOS

### GV-MDR

Camera Model	Image Sensor
GV-MDR120	1/3" progressive scan low lux CMOS
GV-MDR1500 Series	1/3" progressive scan super low lux CMOS
GV-MDR220 GV-MDR320 GV-MDR520 GV-MDR5300 Series	1/2.5" progressive scan CMOS
GV-MDR2400 Series GV-MDR3400 Series	1/3.2" progressive scan CMOS
GV-MDR2500 Series	1/2.8" progressive scan super low lux CMOS

- Megapixel lens
- Dual streams from H.264 or MJPEG

- Frame rate

#### GV-MFD

Camera Model	Frame Rate
GV-MFD120 GV-MFD130 GV-MFD1501 series	Up to 30 fps at 1280 x 1024
GV-MFD220 GV-MFD2401 series GV-MFD2501 series	Up to 30 fps at 1920 x 1080
GV-MFD320 GV-MFD3401 series	Up to 20 fps at 2048 x 1536
GV-MFD520 GV-MFD5301 series	Up to 10 fps at 2560 x 1920

#### GV-MDR

Camera Model	Frame Rate
GV-MDR120 GV-MDR1500 series	Up to 30 fps at 1280 x 1024
GV-MDR220 GV-MDR2400 series GV-MDR2500 series	Up to 30 fps at 1920 x 1080
GV-MDR320 GV-MDR3400 series	Up to 20 fps at 2048 x 1536
GV-MDR520 GV-MDR5300 series	Up to 10 fps at 2560 x 1920

- Day and night function (electronic)
- Wide Dynamic Range (WDR)
- Wide Dynamic Range Pro (WDR Pro for GV-MFD2401 series / 3401 series and GV-MDR2400 series / 3400 series)
- Defog
- Vandal resistance (IK10 for metal casing, GV-MDR series only)

- Ingress protection (IP67 for GV-MDR series only)
- EN50155 compliance for rolling stock applications (for GV-MDR series only)
- Endurable to low environment temperatures (-30°C ~ 50°C / -22°F ~ 122°F) (for GV-MDR series only)
- 2-axis mechanism (GV-MFD series); 3-axis mechanism (GV-MDR series)

Camera Type	Pan	Tilt	Rotate
GV-MFD series	-45° ~ +45°	0° ~ 90°	N/A
GV-MDR series	-45° ~ +45°	0° ~ 90°	0° ~ 360°

- Micro SD card slot (SD/SDHC) for local storage
- USB slot for GV-WiFi adapter or USB hard drive (for GV-MFD1501 Series / 2401 series / 2501 series / 3401 series / 5301 series)
- Built-in microphone
- Two-way audio (for GV-MFD1501 Series / 2401 series / 2501 series / 3401 series / 5301 series)
- Motion detection
- Tampering alarm
- Privacy mask
- Text overlay
- IP address filtering
- Support for iPhone, iPad, Android and 3GPP
- 31 languages on Web interface
- ONVIF (Profile S) conformant

## 6.3 Overview

### 6.3.1 GV-MFD120 / 130 / 220 / 320 / 520



Figure 6-1

No.	Name	Description
1	Default Button	Resets the camera to factory default. See <i>22.3 Restoring to Factory Default Settings</i> .
2	Lens	Receives image inputs.
3	Tilt Screw	Loosens the screw to adjust tilt angle.
4	Microphone	Provides one-way audio.
5	Pan Screw	Loosens the screw to pan.
6	LED Indicators	See <i>LED Indicators</i> below.
7	Memory Card Slot	Inserts a micro SD card (SD/SDHC, version 2.0 only, Class 10) to store recording data.

<b>LED Name</b>	<b>Description</b>
1. Link	Turns on when the network is connected.
2. ACT	Turns on when data are being transmitted.
3. PWR	Turns on when power is on.
4. SW RDY (Status)	Turns on when the system is ready.

### 6.3.2 GV-MFD1501 Series / 2401 Series / 2501 Series / 3401 Series / 5301 Series

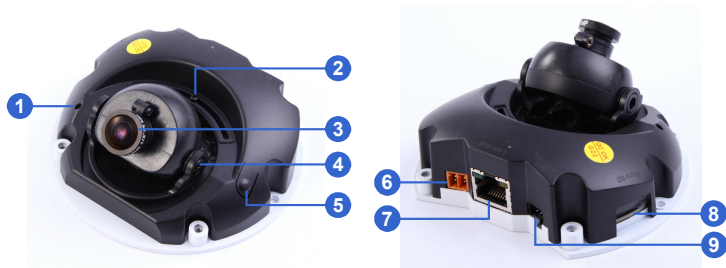

Figure 6-2

No.	Name	Description
1	Microphone	Receives sound.
2	Pan Screw	Loosens the screw to pan.
3	Lens	Receives image inputs.
4	Tilt Screw	Loosens the screw to adjust tilt angle.
5	Default Button	Resets the camera to factory default. See <i>22.3 Restoring to Factory Default Settings</i> .
6	DC 5V Power Port	Connects to power.
7	LAN / PoE	Connects to a 10/100 Ethernet or PoE.
8	Memory Card Slot	Inserts a micro SD card (SD/SDHC, version 2.0 only, Class 10) to store recording data.
9	USB and Audio Out	Connects to a GV-WiFi Adapter/USB hard drive and a speaker through the supplied Y cable.

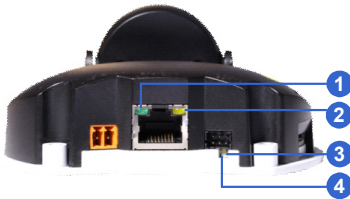

Figure 6-3

LED Name	Description
1. Link	Turns on (green) when the network is connected.
2. ACT	Turns on (orange) when data are being transmitted.
3. Status	Turns on (red) when the system is ready.
4. Power	Turns on (green) when power is on.

---

**Note:** For details on limitations and requirements of the USB port, refer to *Note for USB Storage and WiFi Adapter* at the beginning of this manual.

---

## 6.3.3 GV-MDR



Figure 6-4

No.	Name	Description
1	Silica gel bag	Absorbs the moisture inside the camera.
2	Conceal paper	Prevents water or moisture from entering the camera.
3	Lens	Receives image inputs.
4	Rotation Disc	Rotates the camera lens.
5	Pan Disc	Pans the camera lens.
6	Tilt Screw	Loosens to tilt the camera.
7	Microphone	Provides one-way audio.



No.	Name	Description
8	Default Button	Resets the camera to factory default. See <i>22.3 Restoring to Factory Default Settings</i> .
9	Power and status LED	Turns red when the power is on. Flashes orange light twice when the system is ready.
10	LAN LED	Turns on when the network is connected.
11	Memory Card Slot	Inserts a micro SD card (SD/SDHC, version 2.0 only, Class 10) to store recording data.

---

**IMPORTANT:** In case of damage and possible condensation inside the camera housing, be sure not touch or remove the conceal paper.

---

### LAN Connector

Three connector options are available for GV-MDR1500 series / 2400 series / 2500 series / 3400 series / 5300 series. Select an option based on your installation environment.

#### 1. M12 Connector

The M12 connector is used for motor vehicles.

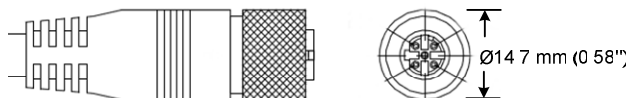

## 2. Waterproof Connector

For this connector type, see 6.4.2 *GV-MDR* to install the supplied cable connector.

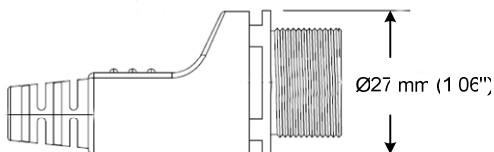

## 3. Non-waterproof (Smaller) Connector

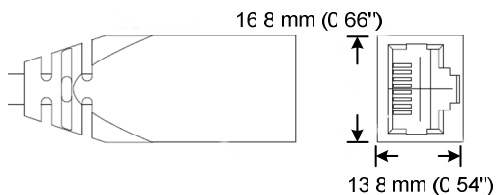

## 6.4 Installation

To install a Mini Fixed Dome, make sure the installing site is shielded from rain and moisture.

### 6.4.1 GV-MFD Series

1. Unscrew the housing cover using the supplied torx wrench.
2. Put the camera on the desired location and make 2 marks on the ceiling for screw anchors. If you want to run the cables inside the ceiling, make a round mark with a diameter of 2.5 cm.
3. Drill the marks and insert the screw anchors.
4. Secure the Mini Fixed Dome to the ceiling with the self-tapping screws.
5. Connect the camera to network and power. For details, see 6.5 *Connecting the Camera*.
6. Access the live view. For details, see 18.1 *Accessing the Live View*.
7. Adjust the angles based on the live view.

**Pan Adjustment**



*Figure 6-5*

**Tilt Adjustment**

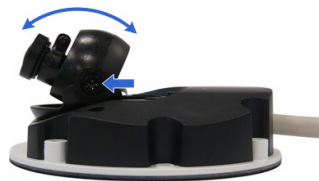

*Figure 6-6*

8. Insert a Micro SD card (SD/SDHC, version 2.0 only, Class 10) into the memory card slot (No. 7, Figure 6-1).
9. Secure the housing cover using the supplied torx wrench.
10. Optionally conceal the cable opening with the supplied cable stopper.



*Figure 6-7*

## 6.4.2 GV-MDR Series

1. Paste the installation sticker on the desired location. The arrow should point toward the direction that the camera faces.
2. Drill one hole on each of the two curves for screw anchors. Drill the circle (30 mm in diameter) if you want to run the cable into the ceiling.

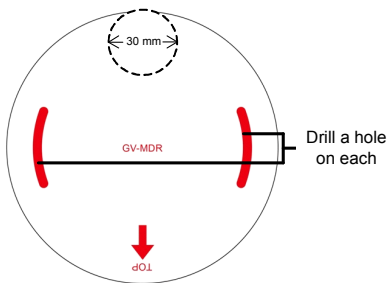

Figure 6-8

3. Insert the screw anchors.
4. Unscrew the housing cover using the supplied torx wrench.
5. Secure the camera body to the ceiling with the self-tapping screws.



Figure 6-9

6. Install the cable connector to waterproof the cable. You should have 5 parts:



*Figure 6-10*

- A. Prepare an internet cable with the RJ-45 connector on one end only.



*Figure 6-11*

- B. Connect the internet cable to the camera cable.  
C. Paste the sticker to the camera cable and slide in all the components as shown below.



*Figure 6-12*

- D. Move all the components toward the RJ-45 connector, fit item 4 to item 2, secure item 3 to the camera cable and finally secure item 5 to item 2 tightly.



Figure 6-13

---

**IMPORTANT:** Item 5 must be secured tightly to waterproof the cable.

---

7. Access the live view. For details, see *18.1 Accessing the Live View*.
8. Adjust the angles based on the live view.

### Pan Adjustment



Figure 6-14

### Tilt Adjustment

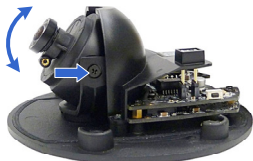

*Figure 6-15*

### Rotational Adjustment



*Figure 6-16*

9. Insert a Micro SD card (SD/SDHC, version 2.0 only, Class 10) into the memory card slot (No. 11, Figure 6-2).
10. Replace the silica gel bag.

---

#### **IMPORTANT:**

1. The silica gel bag loses its effectiveness when the dry camera is opened. To prevent the lens from fogging up, replace the silica gel bag every time you open the camera, and conceal the gel bag in camera within 2 minutes of exposing to open air.
  2. For each newly replaced silica gel bag, allow it to absorb moisture for at least 5 hours before operating the camera.
-



11. Secure the housing cover using the supplied torx wrench.
12. Optionally conceal the cable opening with the supplied cable stopper.

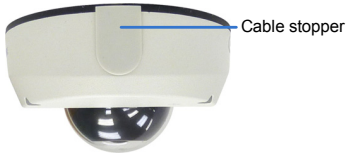

*Figure 6-17*

## 6.5 Connecting the Camera

Refer to the wire definition and illustrations below to connect the power and network.

### 6.5.1 Wire Definition

#### GV-MFD120 / 130 / 220 / 320 / 520

The data cable provides connections for power and network access. The wires are illustrated and defined below:



Figure 6-18

No.	Wire Color	Definition
1	Yellow	DC 12V+
2	Orange	GND
3	Gray	PoE, Ethernet

#### GV-MDR Series

Power and network connectivity is provided through a PoE cable.

Wire Color	Definition
Gray	PoE, Ethernet

## 6.5.2 Power and Network Connection

Use one of the following methods to power on and connect your camera to network:

- **Wired connection with PoE:** Use a Power over Ethernet (PoE) adapter to connect the camera to the network, and the power will be provided at the same time.
- **Wired connection with network cable (GV-MFD Series only):** Connect the camera with a standard network cable and use the power adapter to supply power. The power adapter is an optional device. For detail, see *Options* in the manual. See *Powering On the GV-MFD Series* below to assemble the terminal block with power adapter.
- **Wireless connection (GV-MFD1501 Series / 2401 Series / 2501 Series / 3401 Series / 5301 Series only):** Connect the camera with a GV-WiFi Adapter (optional accessory) and use the power adapter to supply power.

### Powering On the GV-MFD120 / 130 / 220 / 320 / 520

1. Insert the orange wire of the camera to the left pin and the yellow wire to the right pin of the terminal block.



Figure 6-19

2. Connect the power adapter to the terminal block.



Figure 6-20

3. Connect the camera to network using a network cable.

### 6.5.3 Vehicle Installation

To install the **Mini Fixed Rugged Dome** on a vehicle, clip the ferrite core to the camera cable. In accordance to EN 50155, the ferrite core is used for reduction of the cable-based and radiated interferences, ensuring stable image quality. The ferrite core must be attached as close as possible to the camera with the maximum distance of 15 cm.

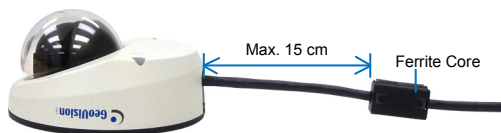

Figure 6-21

## Chapter 7 Target Mini Fixed Dome

The Target Mini Fixed Dome (GV-EFD) is an indoor, fixed, mini-sized network camera equipped with an automatic IR-cut filter and IR LEDs for day and night surveillance. Adjustable in 2 axis (pan and tilt), it offers an entry-level surveillance solution with all the essential features and excellent image quality.

Model No.		Specifications	Description
GV- EFD1100-0F GV- EFD1100-1F	Fixed Lens	Fixed Iris, f: 2.8 / 3.8 mm, F/1.8, 1/2.7" M12 Mount	1.3 MP, H.264, Low Lux, D/N

### 7.1 Packing List

- Target Mini Fixed Dome
- Screw x 2
- Screw Anchor x 2
- GV-IPCAM H.264 Software CD
- GV-IPCAM H.264 Quick Start Guide
- GV-NVR Software DVD
- GV-NVR Quick Start Guide

---

**Note:** Power adapter can be purchased upon request.

---

## 7.2 Features

- 1/3" progressive scan low lux CMOS
- Dual streams from H.264 or MJPEG
- Up to 30 fps at 1280 x 1024
- Intelligent IR
- Day and night function (with removable IR-cut filter)
- 2-axis mechanism (pan / tilt)
- Built-in microphone
- Wide Dynamic Range (WDR)
- Defog
- Motion detection
- Tampering alarm
- Text overlay
- Privacy mask
- IP address filtering
- DV 12V / PoE
- Megapixel lens
- Support for iPhone, iPad, Android and 3GPP
- 31 languages on Web interface
- ONVIF (Profile S) conformant

## 7.3 Overview

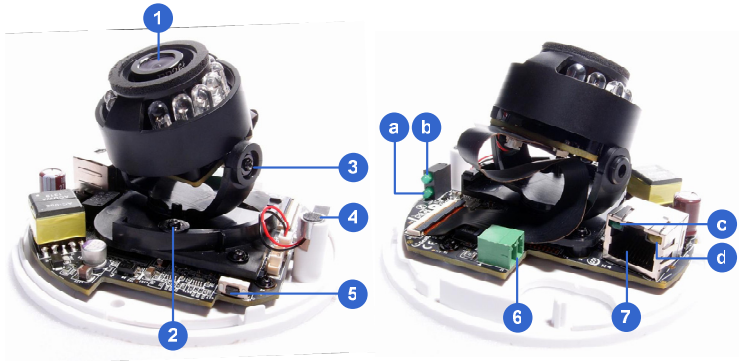

Figure 7-1

No.	Name	Description
1	Lens	Receives image inputs.
2	Pan Screw	Loosens the screw to adjust pan angle.
3	Tilt Screw	Loosens the screw to adjust tilt angle.
4	Microphone	Receives sound.
5	Default Button	Resets the camera to factory default. See 22.3 <i>Restoring to Factory Default Settings</i> .
6	DC 12V Port	Connects to power.
7	LAN / PoE	Connects to a 10/100 Ethernet or PoE.
a	Power	Turns on (green) when power is on.
b	Status	Turns on (green) when the system is ready.
c	Link	Turns on (green) when the network is connected.
d	ACT	Turns on (orange) when data are being transmitted.

## 7.4 Installation

The Target Mini Fixed Dome can be installed on the wall or the ceiling. Before installing the camera, make sure the installing site is shielded from rain and moisture.

1. Open the housing cover by turning.



*Figure 7-2*

2. Place the camera where you want to install it and make 2 marks on the ceiling or the wall for screw anchors. If you want to run the cables inside the ceiling or the wall, make a round mark with a diameter of 2.5 cm.

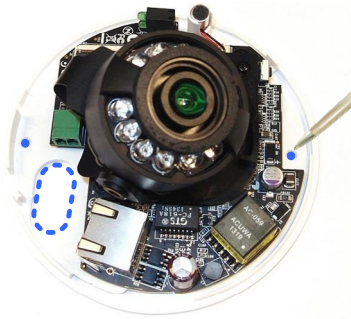

*Figure 7-3*



3. Drill the marks and insert the screw anchors.
4. Thread the power and / or network cable(s) through the oval-shaped hole or the cable opening on the side, and connect the camera to network and power. For details, see *7.5 Connecting the Camera*.

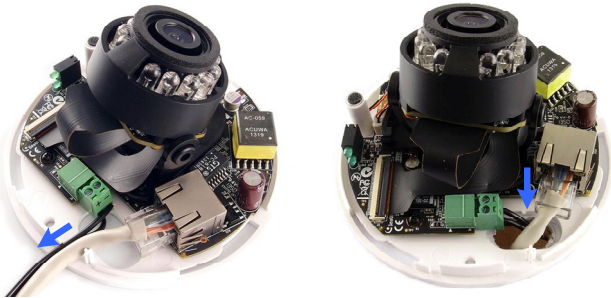

*Figure 7-4*

5. Secure the Target Mini Fixed Dome to the ceiling or the wall with the supplied screws.
6. Access the live view. For details, see *18.1 Accessing the Live View*.

7. Loosen the tilt screw and pan screw, adjust the angles based on the live view as needed, and tighten the screws again.



*Figure 7-5*

8. Place the housing cover back and turn to secure it.

## 7.5 Connecting the Camera

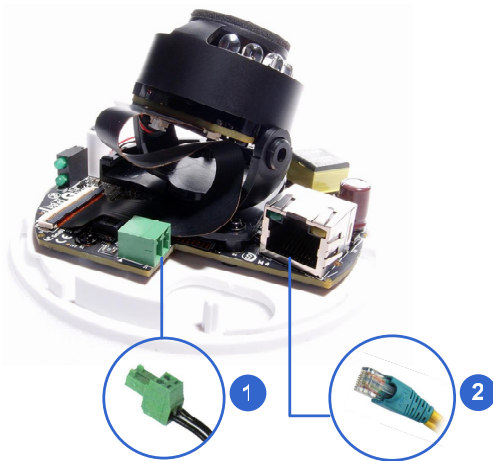

Figure 7-6

1. Connect power using one of the following methods:
  - Plug the power adapter to the 12V terminal block. The power adapter is an optional device. For detail, see *Options* in the manual.
  - Use the Power over Ethernet (PoE) function and the power will be provided over the network cable.

The power and status LEDs shall turn on (green).
2. Use a standard network cable to connect the camera to your network.
3. You are ready to access the live view, adjust the image clarity and configure the basics. See *Getting Started, Chapter 18*.

## Chapter 8 Bullet Camera

The Bullet Cameras are specifically designed for outdoors and are weatherproof (IP66 or IP67). They are equipped with IR LEDs for infrared illumination in night vision applications. The WDR Pro models (see 2.2.1 *Wide Dynamic Range Pro* for details) enhance the image by processing contrasting intensity of light. The super low lux model can produce color live view in near darkness. The motorized varifocal lens models allow the user to adjust the focus and zoom through the Web interface. For related models, see 8.2 *Features*. The following models are available:

Model No.		Specifications	Description
GV-BL120D	Varifocal Lens	Auto Iris, f: 3 ~ 9 mm, F/1.2, 1/2.7" ø 14 mm Lens Mount	1.3 MP, H.264, Low Lux
GV-BL130D			1.3 MP, H.264
GV-BL220D			2 MP, H.264
GV-BL320D			3 MP, H.264
GV-BL1200			1.3 MP, H.264, Low Lux
GV-BL1300			1.3 MP, H.264
GV-BL1500			1.3 MP, H.264, Super Low Lux
GV-BL2400			2 MP, H.264, WDR Pro
GV-BL2500			2 MP, H.264, Super Low Lux
GV-BL3400			3 MP, H.264, WDR Pro

Model No.		Specifications	Description
GV-BL1210	Motorized Varifocal Lens	Auto Iris, f: 3 ~ 9 mm, F/1.2, 1/2.7" ø 14 mm Lens Mount	1.3 MP, H.264, Low Lux, 3X Optical Zoom
GV-BL1510 (Coming)			1.3 MP, H.264, Super Low Lux, 3X Optical Zoom
GV-BL2410			2 MP, H.264, WDR Pro, 3X Optical Zoom
GV-BL2510			2 MP, H.264, Super Low Lux, 3X Optical Zoom
GV-BL3410			3 MP, H.264, WDR Pro, 3X Optical Zoom
GV-BL5310			5 MP, H.264, 2X Optical Zoom

## 8.1 Packing List

- Bullet Camera
- Lens (Megapixel and Built-In 16 IR LEDs)
- Self Tapping Screw x 3
- Plastic Screw Anchor x 3
- Torx Wrench x 2
- Sun-Shield Cover Kit (Sun-Shield Cover, Philips Head Screw x 2, Plastic Screw Spacer x 2 and Hexagon Screw x 2)
- Silica Gel Bag x 2
- 2-Pin Terminal Block
- GV-IPCAM H.264 Software CD
- GV-IPCAM H.264 Quick Start Guide
- GV-NVR Software DVD
- GV-NVR Quick Start Guide

---

**Note:** Power adapter can be purchased upon request.

---

## 8.2 Features

- Image sensor

Camera Model	Image Sensor
GV-BL120D GV-BL1200 / 1210	1/3" progressive scan low lux CMOS
GV-BL1500 GV-BL1510	1/3" progressive scan super low lux CMOS
GV-BL130D / 220D / 320D GV-BL1300 / 5310	1/2.5" progressive scan CMOS
GV-BL2400 / 2410 GV-BL3400 / 3410	1/3.2" progressive scan CMOS
GV-BL2500 / 2510	1/2.8" progressive scan super low lux CMOS

- Dual streams from H.264 or MJPEG

- Frame rate

Camera Model	Frame Rate
GV-BL120D / 130D GV-BL1200 / 1210 / 1300 GV-BL1500 / 1510	30 fps at 1280 x 1024
GV-BL220D / 2400 / 2410 GV-BL2500 / 2510	30 fps at 1920 x 1080
GV-BL3400 / 3410	20 fps at 2048 x 1536
GV-BL5310	10 fps at 2560 x 1920

- Intelligent IR
- Motorized varifocal lens for remote focus/zoom adjustment (for GV-BL1210 / 1510 / 2410 / 2510 / 3410 / 5310 only)
- Day and night function (with removable IR-cut filter)
- Wide Dynamic Range Pro (for GV-BL2400 / 2410 / 3400 / 3410 only)
- Defog

- Ingress protection  
(IP66 for GV-BL120D / 130D / 220D / 320D)  
(IP67 for GV-BL1200 / 1300 / 1500 / 2400 / 2500 / 3400 / 1210 / 1510 / 2410 / 2510 / 3410 / 5310)
- Vandal resistance (IK10 for metal casing, GV-BL1200 / 1300 / 1500 / 2400 / 2500 / 3400 / 1210 / 1510 / 2410 / 2510 / 3410 / 5310 only)
- Cable-concealed bracket preventing cable from being cut
- One alarm input and sensor output
- Micro SD card slot (SD/SDHC) for local storage
- Motion detection
- Tampering alarm
- Visual automation
- Text overlay
- Privacy mask
- IP address filtering
- DC 12V / AC 24V / PoE
- Megapixel lens
- Support for iPhone, iPad, Android and 3GPP
- 31 languages on Web interface
- ONVIF (Profile S) conformant



## 8.3 Overview

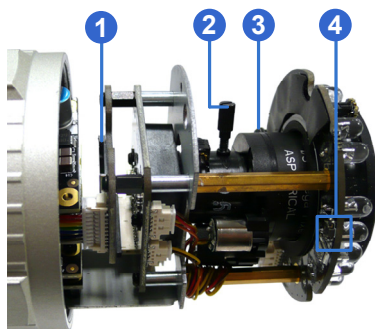

Figure 8-1

No.	Name	Description
1	Memory Card Slot	Receives a micro SD card (SD/SDHC, version 2.0 only, Class 10).
2	Zoom Screw	Holds the zoom lens in place.
3	Focus Screw	Holds the focus lens in place
4	Default Button	Resets all configurations to factory default. See 22.3. <i>Restoring to Factory Default Settings</i> .

## 8.4 Installation

These instructions describe the basic installation of the Bullet Camera.

1. Slide the cable clamp to the camera base.

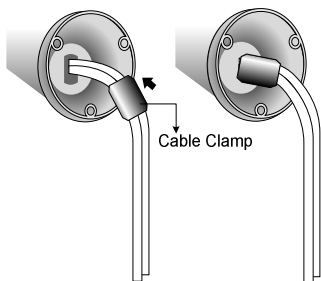

Figure 8-2

2. Install the Bullet Camera to the wall.



Figure 8-3

3. Remove the protection sticker from the camera's cover
4. Connect the power, network and other wires to the Bullet Camera.  
See 8.4.1 *Connecting the Camera*.

5. Access the live view. For details, see *18.1. Accessing the Live View*.
6. Adjust angles of the camera body based on the live view. Three shafts can be adjusted. See *8.4.2 Adjusting the Angles*.
7. Loosen the camera's cover, adjust the focus of the camera and optionally insert a micro SD card (SD/SDHC, version 2.0, Class 10) into the SD card slot. See *8.4.3 Adjusting Lens and Inserting a Memory Card*.
8. Fasten the camera's cover.
9. Install the sun-shield cover to the Bullet Camera. For details, see *8.4.4 Installing the Sun-Shield Cover*.

## 8.4.1 Connecting the Camera

### Wire Definition

The **7-Pin Data Cable** provides connections for power, ground, 1 sensor input, 1 alarm output, audio input and audio output. The wires are illustrated and defined below:

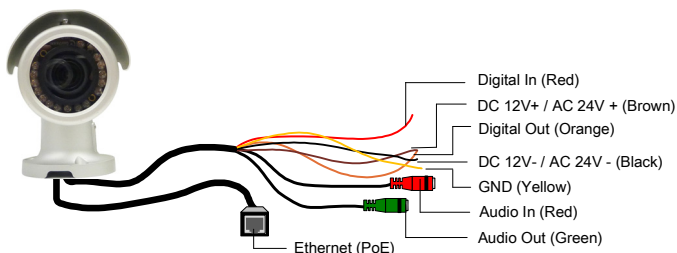
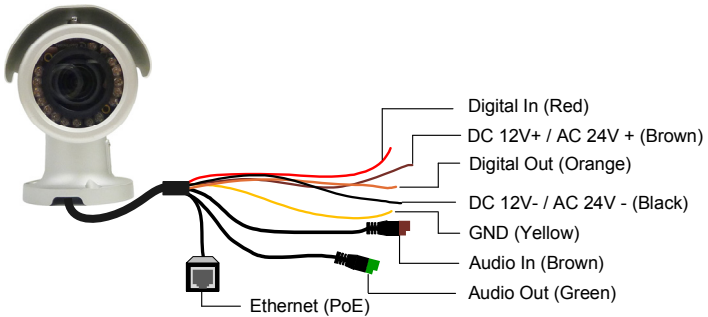

Figure 8-4

No.	Wire Color	Definition
1	Red	Digital In
2	Brown	DC 12V+ / AC 24V+
3	Orange	Digital Out
4	Black	DC 12V- / AC 24V-
5	Yellow	Ground
6	Red RCA	Audio in
7	Green RCA	Audio out

Note that the Audio In and Out connectors may also come as terminal blocks:



*Figure 8-5*

No.	Wire Color	Definition
1	Red	Digital In
2	Brown	DC 12V+ / AC 24V+
3	Orange	Digital Out
4	Black	DC 12V- / AC 24V-
5	Yellow	Ground
6	Brown terminal block	Audio in
7	Green terminal block	Audio out

## Power Connection

There are two ways to supply power to the camera:

- Use a Power over Ethernet (PoE) adapter to connect the camera to the network, and the power will be provided at the same time.
  - Plug the power adaptor to the terminal block as shown below. The power adaptor is an optional device. For detail, see *Options* in the manual.
1. Insert the black wire of the Bullet Camera to the left pin and the brown wire to the right pin.

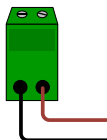

Figure 8-6

2. Connect the DC 12V Power Adaptor to the Terminal Block.



Figure 8-7

### Voltage Load Expansion (Optional)

The camera can only drive a maximum load of **200mA 5V DC**. To expand the maximum voltage load to **10A 250V AC**, **10A 125V AC** or **5A 100V DC**, connect the camera to a GV-Relay V2 module (optional product). Refer to the figure and table below.

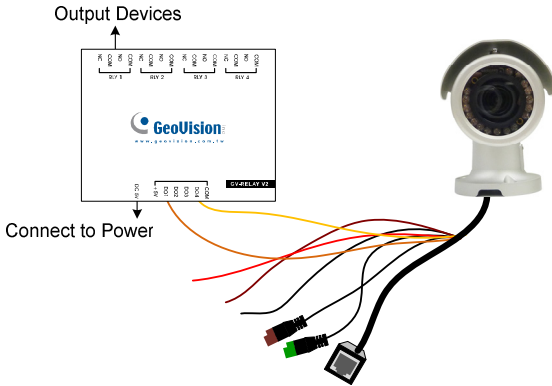

Figure 8-8

GV-Relay V2	Bullet Camera
COM	Ground (Yellow)
DO1	Digital Out (Orange)

## 8.4.2 Adjusting the Angles

The Bullet Camera is designed to be adjustable in three shafts for easy and flexible installation.

### First Shaft

You can adjust the camera body by 360 degrees to the right or the left.

1. Unscrew the panning lock screw with the torx wrench.

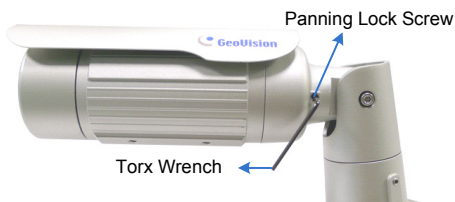

Figure 8-9

2. Adjust the angle of camera body to the right or the left, and fasten the panning lock screw.



Figure 8-10



## Second Shaft

You can adjust the camera body up and down by 90, 112.5, 135, 157.5 or 180 degrees by using the gears inside the camera body and the camera base.

1. Unscrew the tilting lock screw with the torx wrench.



Figure 8-11

2. Hold the camera body, and move the camera base to the right to separate the camera gears.

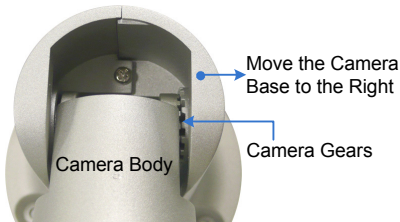

Figure 8-12

- Adjust the angle of camera body to  $90^\circ$ ,  $112.5^\circ$ ,  $135^\circ$ ,  $157.5^\circ$  or  $180^\circ$ . Then move the camera base to the left to combine the gears.

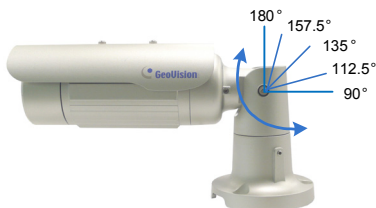

Figure 8-13

- Fasten the tilting lock screw.

### Third Shaft

You can adjust the camera base by  $360^\circ$ .

- Unscrew the base fixing screw with the torx wrench.



Figure 8-14

2. Adjust the angle of camera base, and fasten the base fixing screw.



*Figure 8-15*

### 8.4.3 Adjusting Lens and Inserting a Memory Card

To adjust the camera's lens to produce a clear image and insert a micro SD card (SD/SDHC, version 2.0 only, Class 10) into the SD card slot, follow the steps below.

1. Loosen the camera's cover.



Figure 8-16

2. Remove the silica gel bag.

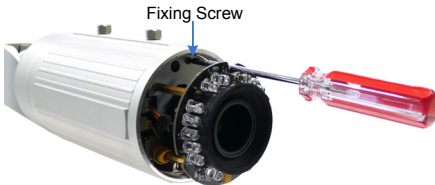

Figure 8-17

3. Adjust for image clarity using GV-IP Device Utility. For details, see [18.2 Adjusting Image Clarity](#).

4. If you want to insert a micro SD card, follow the steps below.

A. Loosen the fixing screw.



*Figure 8-18*

B. Slightly pull out the camera module.

C. Insert a micro SD card (SD/SDHC, version 2.0 only, Class 10) into the memory card slot.

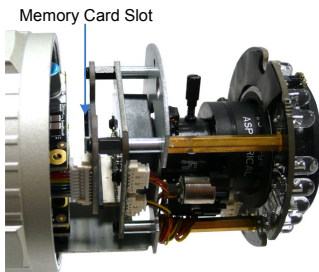

*Figure 8-19*

D. Push the camera module back and fasten the fixing screw.

5. Insert a new silica gel bag to the camera module and fasten the camera's cover within 2 minutes of opening the silica gel bag package.

---

**IMPORTANT:**

1. The silica gel loses its effectiveness when the dry camera is opened. To prevent the lens from fogging up, replace the silica gel bag every time when you open the camera and conceal the gel bag in the camera within two minutes of exposing to the open air.
  2. For each newly replaced silica gel bag, allow it to absorb moisture for at least 5 hours before operating the camera.
-

### 8.4.4 Installing the Sun-Shield Cover

After setting up the Bullet Camera, now you can install the sun-shield cover to the camera.

1. Fasten the hexagon screws either on top or below the camera.

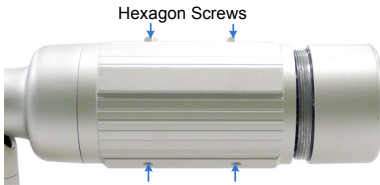

*Figure 8-20*

2. Put the sun-shield cover on top of hexagon screws. Make sure to aim the rear hexagon screw at the edge of the sun-shield cover's aperture for optimal sun-shield performance.



*Figure 8-21*

3. Fasten the Philips head screws with the plastic screw spacers.

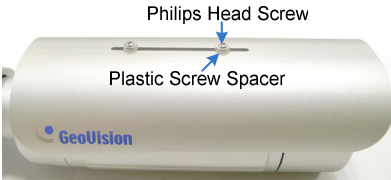

*Figure 8-22*

## Chapter 9 Ultra Bullet Camera

The Ultra Bullet Camera is a series of light-weighted cameras designed for outdoor environments. The camera adheres to the IP67 standard and has full protection against dust and jets of water. The Ultra Bullet Cameras are available in motorized varifocal lens and fixed lens at 1.3, 2 and 3 megapixels. The motorized varifocal lens models allow the user to remotely adjust the focus and zoom through the Web interface. The WDR Pro models can enhance the live view by processing contrasting intensity of lights (see 2.2.1 *Wide Dynamic Range Pro* for details). The super low lux models are able to provide color live view in near darkness. For related models, see 9.2 *Features*.

Model No.		Specifications	Description
GV-UBL1211	Varifocal Lens	Auto Iris, f: 3 ~ 9 mm, F/1.2, 1/2.7" ø 14 mm Lens Mount	1.3 MP Low Lux, H.264, D/N, 3X Optical Zoom
GV-UBL1511			1.3 MP Super Low Lux, H.264, D/N, 3X Optical Zoom
GV-UBL2411			2 MP, H.264, D/N, WDR Pro, 3X Optical Zoom
GV-UBL2511			2 MP Super Low Lux, H.264, D/N, 3X Optical Zoom
GV-UBL3411			3 MP, H.264, D/N, WDR Pro, 3X Optical Zoom



Model No.		Specifications	Description
GV-UBL1301-0F	Fixed Lens	Fixed Iris, f: 3 mm, F/2.0, 1/3" M12 Lens Mount	1.3 MP, Low Lux, H.264, D/N
GV-UBL1301-1F		Fixed Iris, f: 4 mm, F/1.5, 1/3" M12 Lens Mount	
GV-UBL1301-2F GV-UBL1301-3F		Fixed Iris, f: 4 / 8 mm, F/1.6, 1/3" M12 Lens Mount	1.3 MP, Low Lux, H.264, D/N
GV-UBL2401-0F		Fixed Iris, f: 3 mm, F/2.0, 1/3" M12 Lens Mount	2 MP, H.264, D/N, WDR Pro
GV-UBL2401-1F		Fixed Iris, f: 4 mm, F/1.5, 1/3" M12 Lens Mount	
GV-UBL2401-2F GV-UBL2401-3F		Fixed Iris, f: 8 / 12 mm, F/1.6, 1/3" M12 Lens Mount	
GV-UBL3401-0F		Fixed Iris, f: 3 mm, F/2.0, 1/3" M12 Lens Mount	3 MP, H.264, D/N, WDR Pro
GV-UBL3401-1F		Fixed Iris, f: 4 mm, F/1.5, 1/3" M12 Lens Mount	
GV-UBL3401-2F GV-UBL3401-3F		Fixed Iris, f: 8 / 12 mm, F/1.6, 1/3" M12 Lens Mount	

## 9.1 Packing List

- Ultra Bullet Camera (with Waterproof or Non-Waterproof LAN connector)
- Camera Stand
- Black Rubber
- Self Tapping Screw x 3
- Plastic Screw Anchor x 3
- Torx Wrench
- Sun-Shield Cover Kit (Sun-Shield Cover, Philips Head Screw x 2, Plastic Screw Spacer x 2 and Hexagon Screw x 2)
- Cable connector (for waterproof LAN connector only)
- Silica Gel Bag x 2
- 2-Pin Terminal Block
- Data cable
- GV-IPCAM H.264 Software CD
- GV-IPCAM H.264 Quick Start Guide
- GV-NVR Software DVD
- GV-NVR Quick Start Guide

---

**Note:** Power adapter can be purchased upon request.

---

## 9.2 Features

- Image sensor

Camera Model	Image Sensor
GV-UBL1211	1/3" progressive scan CMOS
GV-UBL1301 Series	1/2.5" progressive scan CMOS
GV-UBL1511	1/3" progressive scan super low lux CMOS
GV-UBL2511	1/2.8" progressive scan super low lux CMOS
GV-UBL2411 / 3411 GV-UBL2401 Series GV-UBL3401 Series	1/3.2" progressive scan CMOS

- Dual streams from H.264 or MJPEG
- Frame rate

Camera Model	Frame Rate
GV-UBL1211 / 1511 GV-UBL1301 Series	30 fps at 1280 x 1024
GV-UBL2411 / 2401 Series GV-UBL2511	30 fps at 1920 x 1080
GV-UBL3411 / 3401 Series	20 fps at 2048 x 1536

- Motorized varifocal lens for remote focus/zoom adjustment (for GV-UBL1211 / 1511 / 2411 / 2511 / 3411 only)
- Day and night function (with removable IR-cut filter)
- Wide Dynamic Range Pro (WDR Pro) (for GV-UBL2411 / 3411 / 2401 Series / 3401 Series only)
- Defog
- Ingress protection (IP67)
- Vandal resistance (IK10 for metal casing)
- One alarm input and sensor output

- Micro SD card slot (SD/SDHC) for local storage
- Intelligent IR
- Motion detection
- Tampering alarm
- Visual automation
- Text overlay
- Privacy mask
- IP address filtering
- DC 5V / PoE
- Megapixel lens
- Support for iPhone, iPad, Android and 3GPP
- 31 languages on Web interface
- ONVIF (Profile S) conformant

## 9.3 Overview

### Pane

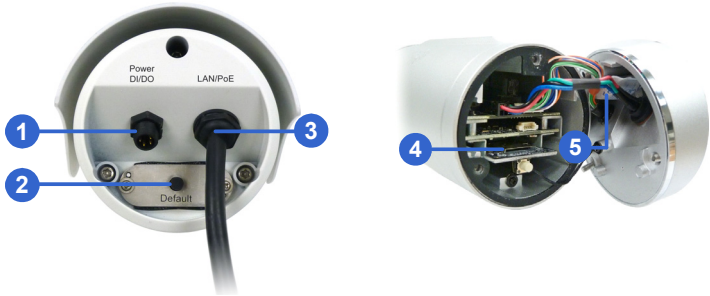

Figure 9-1

No.	Name	Description
1	Power & I/O Connector	Connects to the data cable. For details, see <i>9.4.1 Connecting the Camera</i> .
2	Default Button	Resets all configurations to factory default. See <i>22.3. Restoring to Factory Default Settings</i> .
3	LAN / PoE Cable	Connects to a 10/100 Ethernet or PoE.
4	Memory Card Slot	Receives a micro SD card (SD/SDHC, version 2.0 only, Class 10).
5	Silica gel bag	Desiccant that keeps the camera housing dry.

## LAN Connector

The Ultra Bullet Camera provides two connector types. Select an option based on your installation environment.

- **Option 1 (Waterproof)**

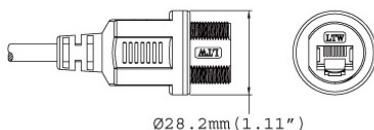

To waterproof the cable, install the supplied cable connector. See [9.4.2 Waterproofing the Cable](#).

- **Option 2 (Smaller and non-waterproof)**

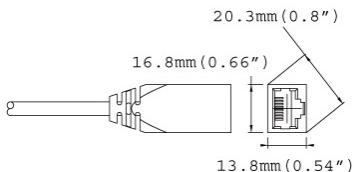

## 9.4 Installation

You can install the camera to the ceiling or wall. Follow the steps below.

1. Install the sun-shield cover to the camera.
  - A. Fasten the hexagon screws to the top or bottom of the camera.

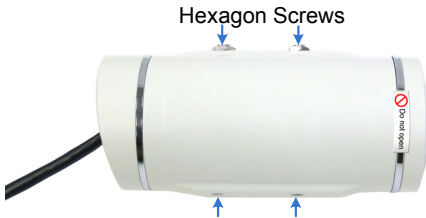

Figure 9-2

---

**IMPORTANT:** Do not open the front cover of the camera since this may impair its resistance to water. The warranty is void if the seal is broken.

---

- B. Put the sun-shield cover on top of the hexagon screws. For optimal sun-shield performance, make sure the rear hexagon screw is at the end of the opening.



Figure 9-3

---

**IMPORTANT:** The GeoVision logo on the sun-shield cover should be closer to the front of the camera.

---

- C. Fasten the Philips head screws with the plastic screw spacers.

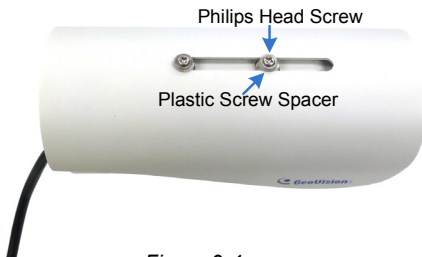

Figure 9-4

- 2. Optionally insert a micro SD card to the camera.
  - A. Unscrew and open the back panel with the supplied torx wrench.



Figure 9-5

- B. Insert a micro SD card (SD/SDHC, version 2.0 only, Class 10) into the card slot.

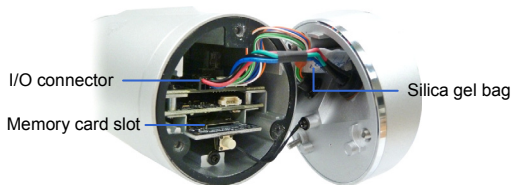

Figure 9-6



- C. Replace the silica gel bag.

---

**IMPORTANT:**

1. The silica gel loses its effectiveness when the dry camera is opened. To keep the interior dry, replace the silica gel bag every time you open the camera and conceal the gel bag in the camera within two minutes of exposing to the open air.
  2. For each newly replaced silica gel bag, allow it to absorb moisture for at least 5 hours before operating the camera.
  3. Make sure the I/O connector is firmly plugged.
- 

- D. Secure the back cover with the supplied torx wrench.
3. Secure the black rubber and the camera stand to the bottom for wall mount or to the top of the camera for ceiling mount.



*Figure 9-7*

4. Install the camera to the wall or ceiling using the screw anchors and self-tapping screws. You can also stand the camera on a plain surface



*Figure 9-8*

5. Remove the protection sticker from the camera's cover.
6. Connect the wires and cable connector to the camera. See [9.4.1 Connecting the Camera](#) and [9.4.2 Waterproofing the Cable](#).
7. Access the live view. For details, see [18.1 Accessing the Live View](#).
8. Adjust angles of the camera body based on the live view.
9. For varifocal models (GV-UBL1211 / 1511 / 2411 / 2511 / 3411), adjust the focus. For details, see [19.2.2 The Control Panel of the Live View Window](#).

## 9.4.1 Connecting the Camera

### Wire Definition

The supplied 4-pin data cable provides connections for power, ground, 1 sensor input and 1 alarm output. The wires are defined below:



Figure 9-9

No.	Wire Color	Definition
1	Red	DC 5V
2	Green	Digital In
3	Blue	Digital Out
4	Black	Ground

## Power Connection

There are two ways to supply power to the camera:

- Use a Power over Ethernet (PoE) adapter to connect the camera to the network, and the power will be provided at the same time.
  - Plug the power adaptor to the terminal block as shown below. The power adaptor is an optional device. For detail, see *Options* in the manual.
1. Insert the black wire of the data cable to the left pin and the red wire to the right pin.

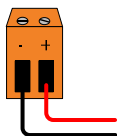

Figure 9-10

2. Connect the DC 5V power adaptor to the terminal block.



Figure 9-11

## 9.4.2 Waterproofing the Cable

Waterproof the option 1 LAN / PoE cable (see 9.3 Overview) using the supplied cable connector. The cable connector can be dissembled into 5 parts:



Figure 9-12

1. Prepare an internet cable with the RJ-45 connector on one end only.



Figure 9-13

2. Connect the internet cable to the LAN / PoE connector (No. 3, Figure 9-1).
3. Paste the sticker to the camera cable and slide in all the components as shown below.



Figure 9-14

4. Move all the components toward the LAN / PoE connector, fit item 4 to item 2, secure item 3 to the camera cable and finally secure item 5 to item 2 tightly.



*Figure 9-15*

---

**IMPORTANT:** Item 5 must be secured tightly to waterproof the LAN / PoE connector.

---

### Voltage Load Expansion (Optional)

The camera can only drive a maximum load of **200mA 5V DC**. To expand the maximum voltage load to **10A 250V AC**, **10A 125V AC** or **5A 100V DC**, connect the camera to a GV-Relay V2 module (optional product).

Refer to the figure and table below.

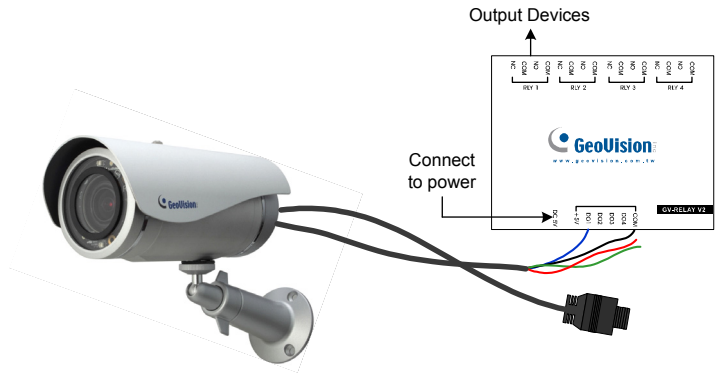

Figure 9-16

GV-Relay V2	Ultra Bullet Camera
DO1	Digital Out (Blue)
COM	Ground (Black)

## Chapter 10 Target Bullet Camera

The Target Bullet Camera (GV-EBL) is a series of light-weighted cameras designed for outdoor environments. The camera adheres to the IP67 standard and has full protection against dust and jets of water. The camera offers an entry-level surveillance solution with all the essential features and excellent image quality.

Model No.		Specifications	Description
GV-EBL1100-0F GV-EBL1100-1F	Fixed Lens	Fixed Iris, f: 3.8 / 6 mm, F/1.8, 1/2.7" M12 Mount	1.3 MP, H.264, Low Lux, D/N

### 10.1 Packing List

- Target Bullet Camera
- Sun-Shield Cover
- Silica Gel Tape x 2
- Supporting Rack
- Screw x 4
- Screw Anchor x 3
- GV-IPCAM H.264 Software CD
- GV-IPCAM H.264 Quick Start Guide
- GV-NVR Software DVD
- GV-NVR Quick Start Guide

---

**Note:** Power adapter can be purchased upon request.

---



## 10.2 Features

- 1/3" progressive scan low lux CMOS
- Dual streams from H.264 or MJPEG
- Up to 30 fps at 1280 x 1024
- Intelligent IR
- Day and night function (with removable IR-cut filter)
- Wide Dynamic Range (WDR)
- Defog
- Vandal resistance (IK10 for metal casing)
- Ingress protection (IP67)
- Motion detection
- Tampering alarm
- Text overlay
- Privacy mask
- IP address filtering
- DC 12V / PoE
- Megapixel lens
- Support for iPhone, iPad, Android and 3GPP
- 31 languages on Web interface
- ONVIF (Profile S) conformant

## 10.3 Overview

### Panel



Figure 10-1

No.	Name	Description
1	Power Connector	Connects to the data cable. For details, see <i>10.5 Connecting the Camera</i> .
2	Default Button	Resets all configurations to factory default. See <i>22.3. Restoring to Factory Default Settings</i> .

---

**IMPORTANT:**

1. The silica gel loses its effectiveness when the camera cover is opened. If you open the camera to access the load default button, replace the silica gel tape by taping the new silica gel tape to the inside of the camera cover. Make sure you conceal the silica gel tape in the camera within two minutes of exposing to the open air.



2. For each newly replaced silica gel tape, allow it to absorb moisture for at least 5 hours before operating the camera.
-

## 10.4 Installation

You can install the camera to the ceiling or wall. Follow the steps below.

1. Slide the sun-shield cover onto the top of the camera.



*Figure 10-2*

---

**Note:** The GeoVision logo on the sun-shield cover should be closer to the front of the camera.

---

2. Line up the screw hole on the camera with the opening on the sun-shield cover.



*Figure 10-3*

3. Ceiling Mount:  
Secure the supporting rack to the opening on the sun-shield cover



*Figure 10-4*

4. Wall Mount:
  - A. Insert and tighten the supplied screw on the sun-shield cover.
  - B. Secure the supporting rack to the bottom.



*Figure 10-5*

5. Install the camera to the wall or ceiling using the screw anchors and self-tapping screws. You can also stand the camera on a plain surface.



*Figure 10-6*

6. Remove the protection sticker from the camera's cover.
7. Connect the wires and cable connector to the camera. See *10.5 Connecting the Camera*.
8. Access the live view. For details, see *19.1. Accessing the Live View*.
9. Adjust angles of the camera body based on the live view.

## 10.5 Connecting the Camera

### Wire Definition

The data cable provides connections for power, ground and network access. The wires are defined below:



*Figure 10-7*

No.	Wire Color	Definition
1	Red	DC 12V
2	Black	Ground
3	Black (thick)	PoE, Ethernet

## Power Connection

There are two ways to supply power to the camera:

- Use a Power over Ethernet (PoE) adapter to connect the camera to the network, and the power will be provided at the same time.
  - Plug the power adapter to the 12V terminal block as shown below. The power adapter is an optional device. For detail, see *Options* in the manual.
1. Insert the black wire of the data cable to the left pin and the red wire to the right pin.

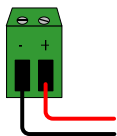

Figure 10-8

2. Connect the DC 12V power adaptor to the terminal block.



Figure 10-9



## Chapter 11 PTZ Camera

The GV-PTZ010D camera is a ceiling-mount device that provides panning, tilting and zooming functions. The camera is designed to monitor a wide area and also to focus on a specific part on the live view when suspicious events occur. There are two models:

Model	Model No.	Description
GV-PTZ010D	GV-PTZ010D-N	NTSC, IPCAM, 10x Optical Zoom, D1, H.264, Fixed Iris
	GV-PTZ010D-P	PAL, IPCAM, 10x Optical Zoom, D1, H.264, Fixed Iris

## 11.1 Packing List

- GV-PTZ010D



- Mounting Cover



- Screw Anchor x 3



- Short Screw x 3



- GV-PTZ010D Software CD

- GV-PTZ110D / GV-PTZ010D Quick Start Guide

- GV-NVR Software DVD

- Mounting Base



- Wall Mount Bracket



- Long Screw x 3



- Round Screw x 3



- Washer x 3



- GV-NVR Quick Start Guide

- Terminal block

---

**Note:** Power adapter can be purchased upon request.

---

## 11.2 Features

- 1/4" CCD image sensor
- Dual streams from H.264, MPEG4 or MJPEG
- Up to 30 fps at 704 x 480 / Up to 25 fps at 704 x 576
- Day and night function (electronic)
- 10x optical zoom lens
- 10x digital zoom
- Pan and tilt (Pan: -175° ~ 175°; Tilt: -45° ~ 90°)
- Micro SD card slot (SD/SDHC) for local storage
- Two-way audio
- One sensor input and alarm output
- Input-triggered Preset points
- Motion detection
- Privacy mask
- IP address filtering
- DC 12 V / AC 24 V / PoE
- Support for iPhone, iPad, Android and 3GPP
- 28 languages on Web interface

## 11.3 Overview



Figure 11-1

No.	Name	Description
1	DC 12V / AC 24V Terminal Block	Connects to a DV 12V or AC 24V Power Adapter.
2	LAN/PoE	Connects to a 10/100 Ethernet or PoE.
3	I/O Terminal Block	For details, see <i>11.7 I/O Terminal Block</i> .
4	Memory Card Slot	Inserts a micro SD card (SD/SDHC, version 2.0 only, Class 10) to store recording data.
5	Audio Out	Connects a speaker for audio output.
6	Audio In	Connects a microphone for audio input.
7	Status LED	Turns green when the system operates normally and turns off when system error occurs.

No.	Name	Description
8	Power LED	Turns green when the power is on and turns off when the power is off.
9	Microphone	Records the sounds.
10	Default	Resets to system default settings. For details, see <i>22.3 Restoring to Factory Default Settings</i> .

## 11.4 Installation

The GV-PTZ010D / GV-PT series is designed for indoor usage. Make sure that the installing location is shielded from rain and moisture. There are two ways to mount the PTZ / PT Camera: **Ceiling Mount** and **L-Shaped Wall Mount**.

### 11.4.1 Ceiling Mount

1. Use the mounting base to make 3 marks on the wall for screw anchors.



Figure 11-2

2. Drill the marks and insert 3 screw anchors.
3. Attach the mounting base with the PTZ / PT Camera with 3 short screws.



Figure 11-3

4. Fix the mounting base (now with the PTZ / PT Camera attached) to the wall with 3 long screws.



*Figure 11-4*

5. Put on the mounting cover. To fit the installation environment, you can cut the parts indicated by arrows to make an opening for wires and cables.



*Figure 11-5*

## 11.4.2 L-Shaped Wall Mount

You may wall-mount the GV-PTZ010D / GV-PT series with or without the mounting cover.

1. Take the wall mount bracket and make 2 marks on the wall for screw anchors.

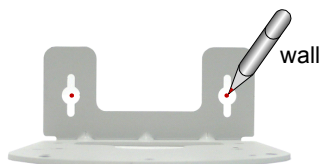

Figure 11-6

2. Drill the marks and insert 2 screw anchors.
3. Insert the long screws and leave enough distance (approximately 2 mm) to hang the wall mount bracket later.

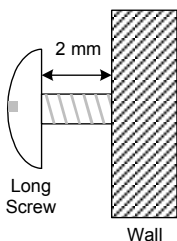
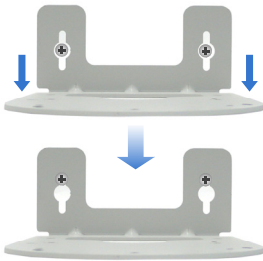

Figure 11-7



4. Hang the wall mount bracket on the screws and push the wall mount bracket downward. Make sure the long screws are tightened.



*Figure 11-8*

5. **Without Mounting Cover**

- Attach the wall mount bracket with the PTZ / PT Camera using 3 washers and 3 round screws.



*Figure 11-9*

**With Mounting Cover**

- To install the mounting cover, attach the mounting base to the camera and then put on the mounting cover. See steps 3 and 5 in the *Ceiling Mount* section.
- Attach the wall mount bracket with the PTZ / PT Camera using 3 round screws.



*Figure 11-10*

## 11.5 Connecting the Camera

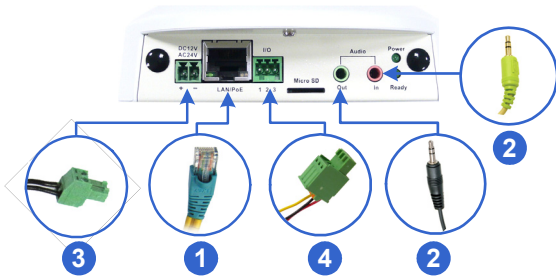

Figure 11-11

1. Use a standard network cable to connect the camera to your network.
2. Optionally connect a speaker and an external microphone.
3. Connect power using one of the following methods:
  - plugging the power adapter to the power port. The power adapter is an optional device. For detail, see *Options* in the manual.
  - using the Power over Ethernet (PoE) function to provide power over the network cable.
4. Optionally connect to an input / output device. For details, see *11.7 I/O Terminal Block*.
5. The status LED of the camera will be on.
6. Access the camera See *18.1. Accessing the Live View*.

## 11.6 Focus Adjustment

On initial installation, it is advised that you adjust the focus for image clarity. Print out the diagram of radiating lines included on Software DVD and hang up the diagram at the surveillance area. Use the **Zoom In / Out** and **Focus In / Out** buttons on the PTZ control panel from the Web interface (No.4 and 5, Figure 11-15) and adjust the PTZ Camera until it displays clear radiating lines as shown in picture on the left.

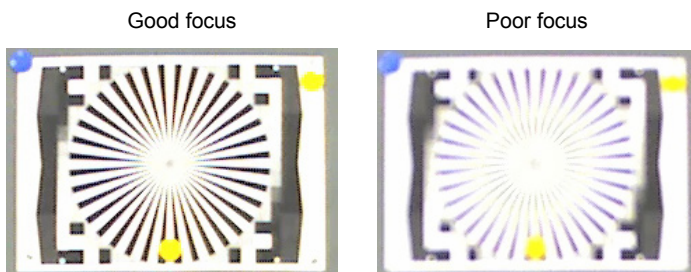

Figure 11-12

To access live view for the first time or to assign an IP address, see 18.1 *Accessing the Live View*.

## 11.7 I/O Terminal Block

The 3-pin terminal block, located on the back panel of the PTZ Camera, provides the interface to one digital input and one digital output. The I/O terminal block can be used for applications such as motion detection, event alerts via E-Mail and FTP, and center monitoring through Center V2 and VSM.

### 11.7.1 Pin Assignment

The pin assignment for the terminal block:

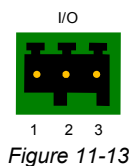

Figure 11-13

Pin	Function
1	Output
2	GND
3	Input

For details on how to enable an installed I/O device, see *20.2 I/O Settings*.

## 11.7.2 Voltage Load Expansion (Optional)

The camera can only drive a maximum load of **200mA 5V DC**. To expand the maximum voltage load to **10A 250V AC**, **10A 125V AC** or **5A 100V DC**, connect the camera to a GV-Relay V2 module (optional product). Refer to the figure and table below.

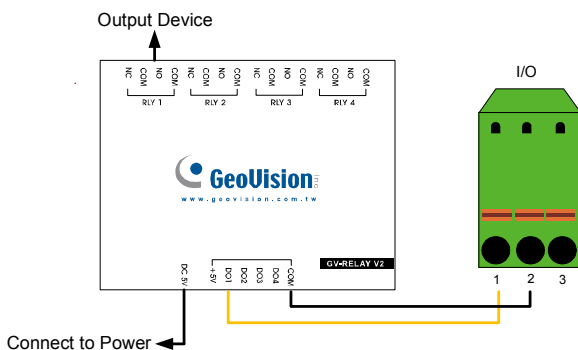

Figure 11-14

GV-Relay V2	I/O Wires
COM	Pin 2 (Ground)
DO1	Pin 1 (Output)

## 11.8 PTZ Control

After you have installed the PTZ Camera on network and accessed the camera's Web interface you are ready to configure the PTZ Camera.

To see how to install the PTZ Camera on network, see *Getting Started, Chapter 18*. To see how to access to live image, see *18.1 Accessing Your Surveillance Images*.

### 11.8.1 The PTZ Control Panel

The control panel allows users to adjust focus, image quality and configure camera movements. On the main page, click the **PTZ Control** button  (No. 9, Figure 19-3) and select **PTZ Control Panel**. The PTZ control panel appears.

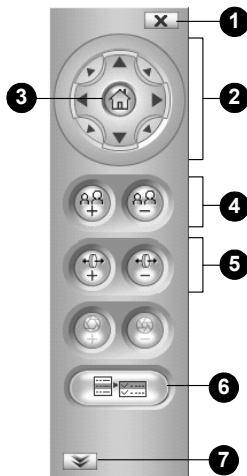

Figure 11-15

Buttons on the PTZ control panel:

No.	Name	Description
1	Exit	Closes the PTZ control panel.
2	Pan / Tilt Control	Moves the PTZ Camera to 8 directions: up, down, left, right, left up, left down, right up and right down.
3	Home	Brings the camera view back to the home point where the camera faces front at a 90 degree angle to the base of the device.
4	Zoom In / Out	Shortens (zoom in) or lengthens (zoom out) the apparent distance between the camera and the view.
5	Focus In / Out	Adjusts the sharpness of the camera view.
6	Option	Brings up these functions: Auto focus, PTZ speed, maximum number of preset points, image quality, Preset point, Sequence, Auto Pan, digital zoom and default loading. See <i>11.8.2 Automatic Focus</i> , <i>11.8.3 PTZ Camera Settings</i> , <i>11.8.4 Image Settings</i> , <i>11.8.5 Preset Settings</i> , <i>11.8.6 Sequence Settings</i> , <i>11.8.7 Auto Pan Settings</i> , <i>11.8.8 System Configuration</i> .
7	Show Preset	Opens and closes the number pad. For details, see <i>11.8.5 Preset Settings</i> .



## 11.8.2 Automatic Focus

When the camera view is fuzzy, you may use the auto focus feature to obtain a sharper view. On the PTZ control panel, click the **Option** button (No. 6, Figure 11-15) and select **AF** for automatic focus.

## 11.8.3 PTZ Camera Settings

### Accessing the PTZ Camera Settings

To access PTZ camera settings, click the **Option** button (No. 6, Figure 11-15) on the PTZ control panel and select **Setup**. The setup dialog box appears.

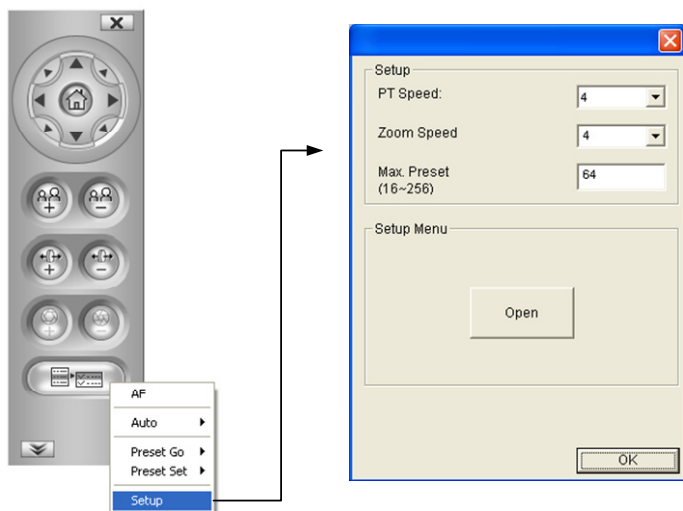

Figure 11-16

- **PT Speed:** Determines the panning (horizontal movement) and tilting (vertical movement) speed when using the **Pan / Tilt Control** buttons on the PTZ control panel. The drop-down list contains 5 speed settings: 1 is the slowest and 5 the fastest.
- **Zoom Speed:** Determines the zooming speed. The drop-down list contains 4 speed settings: 1 is the slowest and 4 the fastest.
- **Max. Preset:** Determines the maximum number of Preset points allowed to be configured and accessed. The number of Preset points ranges from 16 to 256.

### Accessing the VISCA OSD Configuration

The VISCA OSD Configuration contains three groups of settings: image settings, PTZ settings and system configuration. To access these settings, click the **Option** button (No.6, Figure 11-15), select **Setup** and click **Open**. The dialog box appears. Alternatively, you can click **Digital I / O and PTZ** on the Web interface and select **PTZ Setting**.

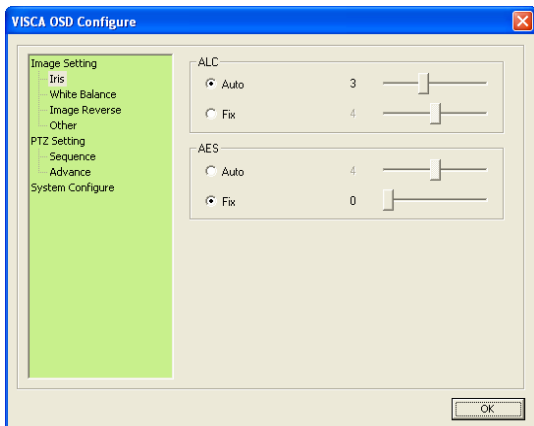

Figure 11-17

## 11.8.4 Image Settings

Image Setting provides features on iris control, white balance, image orientation and other image processing tools to generate clearer images. To access these features, open the VISCA OSD Configuration dialog box and select **Image Setting**.

**[Iris]** adjusts the amount of exposure.

- **ALC:** Automatic Light Control (ALC) is used to adjust light levels.
  - **Auto:** The amount of exposure is automatically adjusted. Select **Auto** to enable this option. If the adjusted image is still too dark or bright, move the slider. A higher value makes the image brighter.
  - **Fixed:** The amount of exposure is controlled by different aperture size. Use the slider to select from 0 to 8. A higher value signifies a bigger aperture and therefore makes the image brighter.
- **AES:** Automatic Electronic Shutter (AES) adjusts the amount of exposure by different shutter speeds.
  - **Auto:** The shutter speed is automatically adjusted. To enable this option, select **Auto**. If the adjusted image is still too dim or bright, use the slider to select from 0 to 8. A higher value indicates a slower shutter speed and therefore produces brighter image.
  - **Fixed:** The shutter speed for each level is fixed. Use the slider to select from 0 to 8. A higher value indicates a faster shutter speed and therefore produces a dimmer image.

**[White Balance]** Adjusts the color intensity to make the images normal to the human eye.

- **ATW:** Auto Tracking White Balance (ATW) automatically adjusts the color intensity for scenes with changing light source. Use the slider to select from 0 to 8. A higher value produces a brighter image and a lower value produces a more yellowish image.

- **AWB:** Automatic White Balance (AWB) automatically compensates for colors under different light levels. AWB is ideal for scenes with a fixed light source. Use the slider to select from 0 to 8. A higher value produces a brighter image and a lower value produces a dimmer image.
- **R Gain:** Adjusts the red element of the live view. Use the slider to select from 0 to 8. A higher value indicates a stronger degree of red.
- **B Gain:** Adjusts the blue element of the live view. Use the slider to select from 0 to 8. A higher value indicates a stronger degree of blue.

### [Image Reverse]

- **Positive/Negative:** With the Positive mode, the colors in the live view appear as it is through the eye. With the negative mode, colors in live view are changed to their complementary colors (opposite colors), i.e. black will be changed to white, red to green etc. Use the drop-down list to select between **Positive** and **Negative** mode.
- **H Reverse:** Reverses the view horizontally. Use the drop-down list to select On or Off.
- **V Reverse:** Reverses the view vertically. Use the drop-down list to select On or Off.

### [Other]

- **BLC:** Backlight Compensation (BLC) is used to compensate AGC in adjusting color intensity. For scenes with strong light in the background and dim light in the foreground, AGC is not effective because AGC averages the light intensity of a whole frame. BLC compensates for this characteristic by restricting AGC to adjust color intensity of a specific area. To turn on, use the drop-down list, select **On**, and select a level among 0 to 7. A higher value indicates a stronger compensation effect.

## ■ AGC

- ⊙ **Freeze:** Instantly freezes the live view image when **On** is selected.
- ⊙ **AGC:** Automatic Gain Control (AGC) utilizes an electronic circuit which amplifies video signal when the signal strength falls below a given value due to lack of the light on the camera. Adjust camera sensitivity to provide clear images. Under strong light intensity, AGC decreases the camera sensitivity to produce dimmer images. Under weak light intensity, AGC increases the camera sensitivity to produce brighter images. To adjust AGC, use the slider to select among 0 to 8. A higher value produces brighter images.
- ⊙ **Sense Up:** Use the slider to select among 0 to 8. A higher value produces brighter images.

## ■ APC: Aperture Compensation (APC) is used to adjust the sharpness of the image.

- ⊙ **H Gain:** Sharpens the horizontal elements of the image. Use the slider to adjust the horizontal compensation between 0 and 12.
- ⊙ **V Gain:** Sharpens the vertical elements of the image. Use the slider to adjust the vertical compensation between 0 and 12.

## ■ Gamma: Adjusts the contrast of the image. Use the drop-down list to select between 1 and 2. The “2” option produces stronger contrast.

### 11.8.5 Preset Settings

For PTZ Camera to automatically move toward a point in live view, establish a Preset. A Preset is a point in live view that can be configured and saved for future use. The PTZ Camera allows up to **256** Preset points. For details on the maximum number of Preset points, see *11.8.3 PTZ Camera Settings*.

#### Configuring a Preset Point

To configure a Preset point:

- 1 Use one of the **Pan / Tilt Control** buttons (No. 2, Figure 11-15) to move the camera to a desired point in live view.
- 2 To save this Preset point, click the **Option** button (No. 6, Figure 11-15), select **Preset Set** and select the desired Preset number
- 3 A confirmation message appears. Click **Yes**.
- 4 To configure more Preset points, repeat steps 1 to 3 and select a different Preset number to save.

## Renaming a Preset Point

To rename a Preset point:

- 1 Click the **Option** button (No. 6, Figure 11-15), select **Preset Set** and select **Naming**. The dialog box appears.

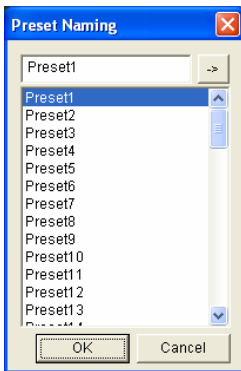

*Figure 11-18*

- 2 Click the Preset point you wish to rename and type the new name in the blank at the top.
- 3 Click  and click **OK** to save.

## Starting and Stopping a Preset Point

To start a Preset movement, click the **Option** button (No. 6, Figure 11-15), select **Preset Go**, and select a **Preset** number which has been set previously.

Alternatively, you may use the number pad on the PTZ control panel to enable a Preset movement:

- 1 Click the **Show Preset** button (No. 7, Figure 11-15) to open the number pad.
- 2 Click the number of Preset point.
- 3 Click  to start.

To stop a Preset movement, click the **Home** button (No. 3, Figure 11-15) or click one of the **Pan / Tilt Control** button (No. 2, Figure 11-15).



## 11.8.6 Sequence Settings

For PTZ Camera to automatically perform a series of movements, you can configure a Sequence. A Sequence links up more than two Preset points to form a sequence of movements. Up to 8 Sequences can be created.

### Configuring a Sequence

- 1 After you have configured the Preset points you wish the camera to follow (for details, see 11.8.5 *Preset Settings*), you are ready to configure a **Sequence**.
- 2 Open the VISCA OSD Configuration dialog box and select **Sequence**.

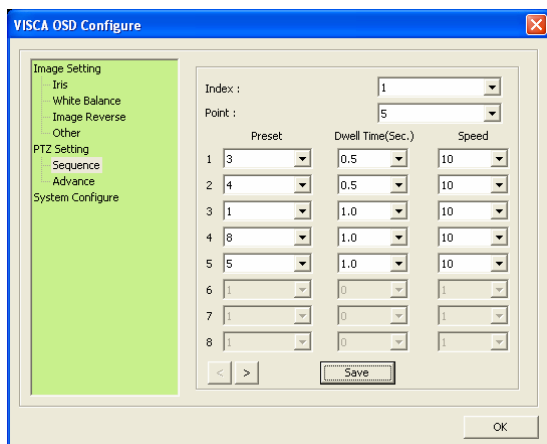

Figure 11-19

- 3 Use the **Index** drop-down list to select the Sequence number you wish to configure. Up to 8 Indexes can be created.
- 4 Use the **Point** drop-down list to select the number of Preset points to be included in the Sequence. A Sequence can contain up to 32 Preset points.

- 5 Use the **Preset** drop-down list to select the Preset points for the Sequence.
- 6 Use the **Dwell Time** drop-down list to select the staying time that the camera stays at the Preset point. The dwell time ranges from 0 to 127 seconds at an interval of 0.5 second.
- 7 Use the **Speed** drop-down list to select the speed at which the camera moves toward the Preset point.
- 8 To configure another Sequence, repeat steps 3 to 8 and select a different Index number.
- 9 Click **Save** to complete the settings.

### Starting and Stopping a Sequence

To start a Sequence, click the **Option** button (No. 6, Figure 11-15) select **Auto** and select a **Go Sequence** number which you have set previously.

To stop a Sequence, click on a **Pan / Tilt Control** button (No. 2, Figure 11-15) or the **Home** button (No. 3, Figure 11-15).

## 11.8.7 Auto Pan Settings

For the PTZ Camera to survey a horizontal view, establish an Auto Pan. Up to 4 sets of Auto Pan can be created.

### Configuring an Auto Pan

To configure a horizontal movement:

- 1 Adjust the angle of the camera view using the **Up** and **Down Control** buttons since any vertical movements of the camera will not be recorded by Auto Pan.
- 2 On the control panel, click the **Option** button (No. 6, Figure 11-15), select **Auto** and select a **Set Auto Pan** number.
- 3 Click the **Right** or the **Left Control** buttons on the PTZ control panel to perform the desired movement.
- 4 Click the **Option** button (No. 6, Figure 11-15), select **Auto** and select an **End Auto Pan** number to save this configuration.

## Configuring the Speed of Auto Pan

You can configure the speed for each set of Auto Pan differently:

- 1 Open the VISCA OSD Configuration dialog box and select **Advance**.

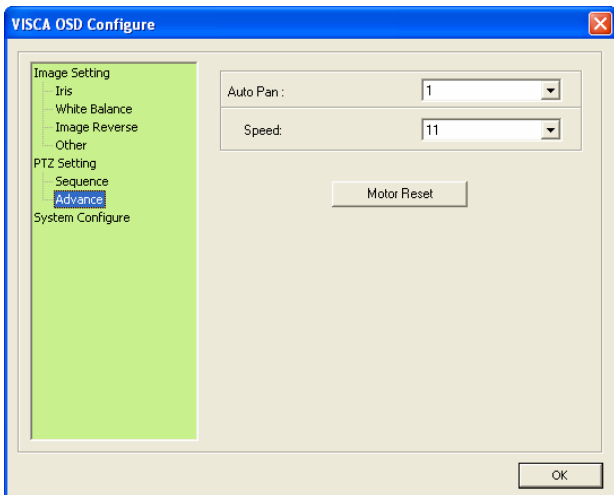

Figure 11-20

- 2 Select the **Auto Pan** number you wish to configure and select the **Speed**.
- 3 To configure the speed of another Auto Pan, repeat step 2.
- 4 Click **OK**.

## Starting and Stopping Autopan

To start an Auto Pan, click the **Option** button (No. 6, Figure 11-15), select **Auto** and select a desired **Auto Pan** number. The PTZ Camera will first return to the starting position of the selected Auto Pan and proceeds with the selected Auto Pan movement.

To stop Auto Pan, click the **Option** button (No. 6, Figure 11-15), select **Auto** and select **Autopan Stop**. Alternatively click on a **Pan / Tilt Control** button (No. 2, Figure 11-15) or the **Home** button (No. 3, Figure 11-15).

## Rebooting the Camera

When the system crashes and fails to respond to the PTZ control panel, reboot the camera.

- 1 Open the VISCA OSD Configuration dialog box.
- 2 Click the **Motor Reset** button to reboot.
- 3 Wait until the camera has panned and tilted its full range and returned to the home point.

## 11.8.8 System Configuration

To configure lens settings, open the VISCA OSD Configuration dialog box and select **System Configure**.

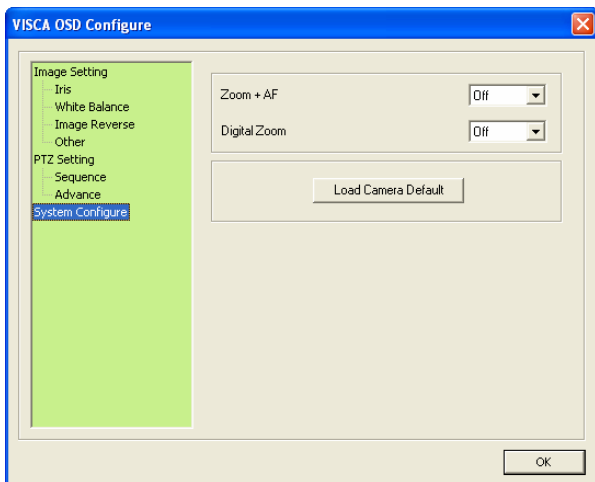

Figure 11-21

- **Zoom + AF:** Automatically focuses after zooming. It is advised to use this feature with a zooming distance of at least 1 meter.
- **Digital Zoom:** Allows up to 10x Digital Zoom. This function is enabled after the Optical Zoom level is fully reached Use the drop-down list to select among off, 2x, 4x, 6x, 8x and 10x.
- **Load Camera Default:** Loads the factory default setting of Iris, White Balance, Image Reverse and Other in the VISCA OSD Configuration dialog box (Figure 11-17).

## Chapter 12 PT Camera

The GV-PT camera is a series of indoor pan and tilt camera that is designed to monitor a wide surveillance area. The camera support remote pan and tilt control and is capable of storing pre-established panning/tilting movements and points on live view for immediate monitoring. Equipped with IR LEDs and IR-cut filter, the GV-PT camera provides excellent image quality in the dark.

### 12.1 Packing List

- GV-PT130D/220D/320D



- Mounting Base



- Mounting Cover



- Wall Mount Bracket



- Screw Anchor x 3



- Long Screw x 3



- Short Screw x 3



- Terminal Block

- GV-IPCAM H.264 Software CD

- GV-NVR Quick Start Guide

- Round Screw x 3



- Washer x 3



- GV-IPCAM H.264 Quick Start Guide

- GV-NVR Software DVD

---

**Note:** Power adapter can be purchased upon request.

---



## 12.2 Features

- 1/2.5" progressive scan CMOS
- Dual streams from H.264 and MJPEG
- Frame rate

Camera Model	Frame Rate
GV-PT130D	30 fps at 1280 x 1024
GV-PT220D	30 fps at 1920 x 1080
GV-PT320D	20 fps at 2048 x 1536

- Pan and tilt (Pan: -175° ~ 175°; Tilt: -45° ~ 90°)
- Input-triggered Preset points
- One sensor input and alarm output
- Built-in / external microphone
- Micro SD card slot (SD/SDHC) for local storage
- DC 12 V / AC 24 V / PoE
- Day/Night function (with removable IR-cut filter)
- Intelligent IR
- Wide Dynamic Range (WDR)
- 2-way audio
- Motion detection
- Defog
- IP address filtering
- Supports iPhone, iPad, Android & 3GPP
- 31 languages on Web interface
- ONVIF (Profile S) conformant

## 12.3 Overview



Figure 12-1

No.	Name	Description
1	DC 12V / AC 24V Terminal Block	Connects to a DV 12V or AC 24V Power Adapter.
2	LAN / PoE	Connects to a 10/100 Ethernet or PoE.
3	I/O Terminal Block	For details, see <a href="#">12.7 I/O Terminal Block</a> .
4	Memory Card Slot	Inserts a micro SD card (SD/SDHC, version 2.0 only, Class 10) to store recording data.
5	Audio Out	Connects a speaker for audio output.
6	Audio In	Connects a microphone for audio input.

No.	Name	Description
7	Status LED	Turns green when the system operates normally and turns off when system error occurs.
8	Power LED	Turns green when the power is on and turns off when the power is off.
9	Focus Ring	Manually rotates this ring left or right to adjust focus.
10	IR	Turns on to automatically illuminate a surveillance area by infrared light to produce clearer images during the night.
11	Microphone	Records the sounds.
12	Default	Resets to system default settings. For details, see <i>22.3 Restoring to Factory Default Settings</i> .

## 12.4 Installation

For installation procedures of the GV-PT Camera, see *11.4 Installation*.

## 12.5 Connecting the Camera

For procedures of connecting the GV-PT Camera, see *11.5 Connecting the Camera*.

## 12.6 Focus Adjustment

After you have followed *11.5 Connecting the Camera* and connected all the necessary cables and wires, follow the steps below to adjust image clarity.

1. Access the live view. For details, see *18.1 Accessing the Live View*.
2. Adjust image clarity using the GV-IP Device Utility program. For details, see *18.2 Adjusting Image Clarity*.

## 12.7 I/O Terminal Block

The 3-pin terminal block, located on the back panel of the PT Camera, provides the interface to one digital input and one digital output. The I/O terminal block can be used for applications such as motion detection, event alerts via E-Mail and FTP, and center monitoring through Center V2 and VSM.

### 12.7.1 Pin Assignment

The pin assignment for the terminal block:

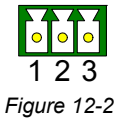

Figure 12-2

Pin	Function
1	Output
2	GND
3	Input

For details on how to enable an installed I/O device, see *20.2 I/O Settings*.

### 12.7.2 Voltage Load Expansion (Optional)

You can install a GV-Relay V2 to expand the maximum voltage load of your GV-PT Camera. For details, see *11.7.2 Voltage Load Expansion*.

## 12.8 PT Control

The GV-PT Camera shares similar user interfaces and features with the GV-PTZ010D camera. See below for the supported functions and reference.

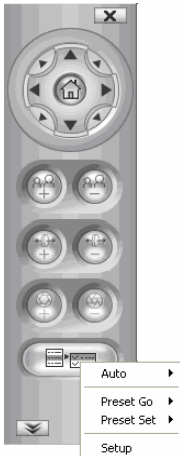
Supported Function	Description
PT Control Panel	<p>The PT camera supports the following buttons on the control panel: <b>Exit</b>, <b>Pan / Tilt Control</b>, <b>Home</b>, <b>Option</b> and <b>Show Preset</b>. For details, see <i>8.8.1 The PTZ Control Panel</i>.</p> 
PT Camera Settings	<p>Contains settings on PT speed and the maximum number of preset points. For details, see <i>Accessing the PTZ Camera Settings in 11.8.3 PTZ Camera Settings</i>.</p>
Preset point	<p>A Preset point is a point in live view that can be configured and accessed using a hot key. For details, see <i>11.8.5 Preset Settings</i>.</p>

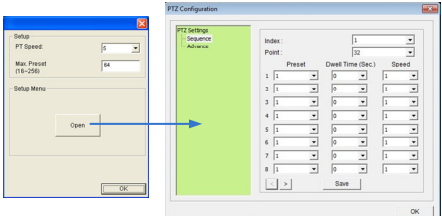
Supported Function	Description
<p>Sequence</p>	<p>A Sequence consists of a series of Preset points. Configure a Sequence to direct the camera to perform s series of movements. For details, see <i>11.8.6 Sequence Settings</i>.</p>  <p>The screenshot shows two overlapping windows. The 'Setup' window on the left has fields for 'PT Speed' (set to 5), 'Max. Preset (16-256)' (set to 64), and an 'Open' button. A blue arrow points from the 'Open' button to the 'PTZ Configuration' window on the right. The 'PTZ Configuration' window has a 'PTZ Settings' section with a tree view containing 'Sequence' and 'Advanced'. Below this is a table with columns 'Preset', 'Dwell Time (Sec.)', and 'Speed'. The table contains 8 rows, each with a 'Preset' dropdown set to '1', 'Dwell Time' set to '0', and 'Speed' set to '1'. There are 'Save' and 'OK' buttons at the bottom.</p>
<p>Auto Pan</p>	<p>The camera can be configured to monitor the surveillance area in a horizontal movement. For details, see <i>11.8.7 Auto Pan Settings</i>.</p>

# Chapter 13 Vandal Proof IP Dome

## (Part I)

The Vandal Proof IP Dome is a series of outdoor camera designed for vandal protection. They are equipped with automatic infrared cut filters and IR LED for day and night surveillance. The WDR Pro models can produce clear image for scenes containing contrasting intensity of lights (see 2.2.1 *Wide Dynamic Range Pro* for details). The super low lux models can display color live view in near darkness. For related models, see 13.2 *Features*.

These Vandal Proof IP Domes can be installed on wall and ceiling using the standard package. They can also be installed on wall corners and poles using the GV-Mount accessories (optional). For more details, see *GV-Mount Accessories Installation Guide* on the Software CD.

Model No.		Specification	Description
GV-VD120D (IK10+, Transparent Cover)	Varifocal Lens	Auto Iris, f:3 ~ 9 mm, F/1.3, 1/2.7" ø 14 mm lens mount	1.3 MP Low Lux, H.264, Vandal Proof IP Dome
GV-VD121D (IK10+, Smoked Cover)			
GV-VD122D (IK7, Transparent Cover)			
GV-VD123D (IK7, Smoked Cover)			



Model No.		Specification	Description
GV-VD220D (IK10+, Transparent Cover) GV-VD221D (IK10+, Smoked Cover) GV-VD222D (IK7, Transparent Cover) GV-VD223D (IK7, Smoked Cover)	Varifocal Lens	Auto Iris, f:3 ~ 9 mm, F/1.3, 1/2.7" ø 14 mm lens mount	2 MP, H.264, Vandal Proof IP Dome
GV-VD320D (IK10+, Transparent Cover) GV-VD321D (IK10+, Smoked Cover) GV-VD322D (IK7, Transparent Cover) GV-VD323D (IK7, Smoked Cover)			3 MP, H.264, Vandal Proof IP Dome
GV-VD1500 (IK10+, Transparent Cover) GV-VD2500 (IK10+, Transparent Cover)	Varifocal Lens	Auto Iris, f:3 ~ 9 mm, F/1.2, 1/2.7" ø 14 mm lens mount	1.3 MP / 2 MP Super Low Lux, Vandal Proof IP Dome
GV-VD2400 (IK10+, Transparent Cover)			2 MP / 3 MP, H.264, WDR Pro, Vandal Proof IP Dome
GV-VD3400 (IK10+, Transparent Cover)			

## 13.1 Packing List

- Vandal Proof IP Dome
- Screw Anchor x 4



- Ceiling Screw x 4



- T-Cap Screw x 3



- T-Cap x 3



- Focus Adjustment Cap



- GV-IPCAM H.264 Quick Start Guide
- GV-NVR Quick Start Guide

- Silica Gel Bag x 2
- Torx Wrench



- Blue Screw x 3



- Small Screw Cap x 3



- Plastic Clip x 3



- 2-Pin Terminal Block

- GV-IPCAM H.264 Software CD
- GV-NVR Software DVD

---

### Note:

1. Focus Adjustment Cap is only needed and supplied for IK10+ models.
  2. Power adapter can be purchased up request.
-

## 13.2 Features

- Image sensor

Camera Model	Image Sensor
GV-VD120D / 121D / 122D / 123D	1/3" progressive scan low lux CMOS
GV-VD1500	1/3" progressive scan super low lux CMOS
GV-VD2500	1/2.8" progressive scan super low lux CMOS
GV-VD2400 / 3400	1/3.2" progressive scan CMOS
GV-VD220D / 221D / 222D / 223D	1/2.5" progressive scan CMOS
GV-VD320D / 321D / 322D / 323D	

- Dual streams from H.264 or MJPEG
- Frame rate

Camera Model	Frame Rate
GV-VD120D / 121D / 122D / 123D / 1500	Up to 30 fps at 1280 x 1024
GV-VD220D / 221D / 222D / 223D / 2400 / 2500	Up to 30 fps at 1920 x 1080
GV-VD320D / 321D / 322D / 323D / 3400	Up to 20 fps at 2048 x 1536

- Day and night function (with removable IR-cut filter)
- Wide Dynamic Range Pro (for GV-VD2400 / 3400 only)
- Defog
- Intelligent IR
- Vandal resistance (IK10+ and IK7)
- Ingress protection (IP67 rating)

- 3-axis mechanism (pan / tilt / roll)
- Micro SD card slot (SD/SDHC) for local storage
- Two-way audio
- One sensor input and alarm output
- TV-out support
- Motion detection
- Tampering alarm
- Visual automation
- Text overlay
- Privacy mask
- IP address filtering
- DC 12V / AC 24V / PoE
- Megapixel lens
- Support for iPhone, iPad, Android and 3GPP
- 31 languages on Web interface
- ONVIF (Profile S) conformant

## 13.3 Overview

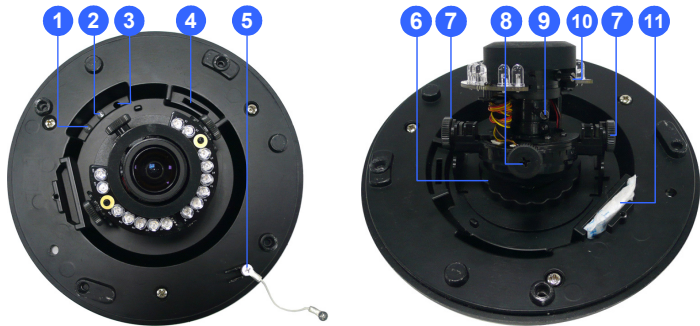

Figure 13-1

No.	Name	Description
1	Power LED	Turns on (green) when the power is on and turns off when there is no power supply.
2	Status LED	Turns on (green) when the system operates normally and turns off when system error occurs.
3	Default Button	Resets to factory default. For details, see <i>22.3 Restoring to Factory Default Settings</i> .
4	Memory Card Slot	Inserts a micro SD card (SD/SDHC, version 2.0 only, Class 10) to store recording data.
5	Thread Lock	Locks the housing cover to the camera body to prevent the cover from falling.
6	Pan Disc	Loosens to pan the camera.
7	Tilt Screw	Loosen the screw to tilt the camera.

**13 Vandal Proof IP Dome (Part I)**

No.	Name	Description
8	Rotational Screw	Loosens to adjust the camera angle.
9	Zoom Screw	Adjusts the zoom of the camera.
10	Focus Screw	Adjusts the focus of the camera.
11	Silica Gel Bag	Absorbs moisture in the camera body.

## 13.4 Installation

The Vandal Proof IP Dome is designed for outdoors. With the standard package, there are two ways to install the Vandal Proof IP Dome: **hard-ceiling mount** and **in-ceiling mount**.

---

**Note:** The standard package allows you to install the camera to the power box of 4" square and double gang. You may also install the camera to ceilings, wall corners (concave or convex), and poles with optional mounting kits. For details, see *GV-Mount Accessories Installation Guide* on the Software CD.

---

### 13.4.1 Hard-Ceiling Mount



Figure 13-2

1. Unpack the camera package and take out the camera body.

Unscrew the  
housing cover



### 13 Vandal Proof IP Dome (Part I)

Unscrew thread lock



Unscrew the inner housing



Take out the camera body





2. Mark the position of four screw holes on the desired installation location, and drill holes in the marked locations. Drill the ellipse part if you wish to put the wires through it.



Figure 13-3

3. Insert the screw anchors to the 4 holes on the ceiling.
4. Secure the back cover to the ceiling with 4 ceiling screws.

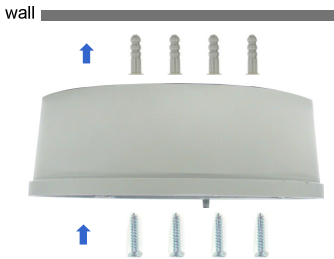

Figure 13-4

5. Refer to step 1 to secure the camera body with inner housing.
6. Thread the cable through the conduit entry at the side of the back cover. Alternatively pass the wires through the ellipse hole at the bottom of the back cover.

7. Connect the network, power and other cables to the camera. See *13.5 Connecting the Camera*.
8. Access the live view. See *18.1 Accessing the Live View*.
9. Based on the live view, adjust the camera to a desired angle as illustrated below.

---

**Tip:** The 3-axis mechanism offers flexible and easy installation.

---

### Pan Adjustment

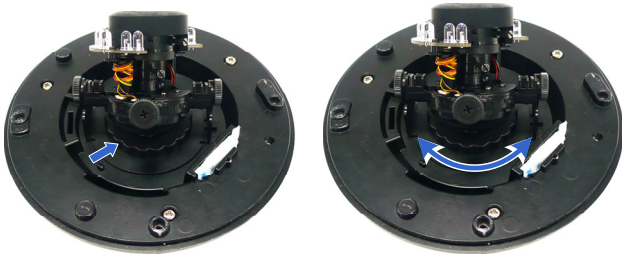

Figure 13-5

### Tilt Adjustment

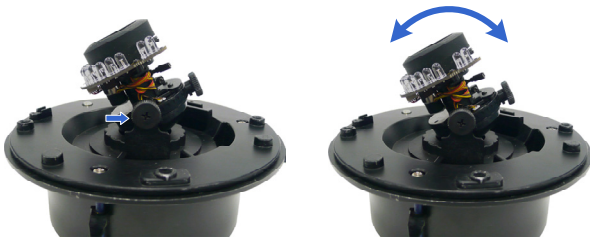

Figure 13-6

## Rotational Adjustment

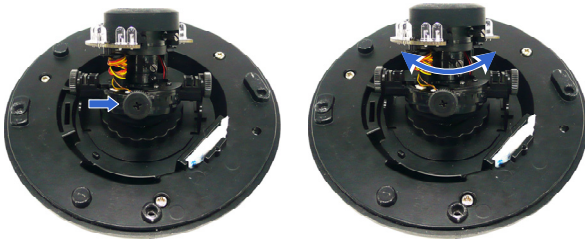

Figure 13-7

10. Adjust image clarity using the GV-IP Device Utility program. For details, see *18.2 Adjusting Image Clarity*.
11. Screw on the thread lock as shown in step 1.
12. Replace the silica gel bag on the camera body within 2 minutes of opening the silica gel bag package.
13. Secure the housing cover to the camera body as shown in step 1.

---

**Note:** Adjust the black mask inside the housing cover to make sure the camera view is not obscured.

---

### IMPORTANT:

1. The gel bag loses its effectiveness when the dry camera is opened. To prevent the lens from fogging up, replace the silica gel bag every time you open the camera and conceal the silica gel bag within 2 minutes of exposing to open air.
  2. For each newly replaced silica gel bag, allow it to absorb moisture for at least 5 hours before operating the camera.
  3. Make sure the housing cover is properly secured to prevent water from entering and damaging the inner housing.
-

### 13.4.2 In-Ceiling Mount



Figure 13-8

1. Follow step 1 in 13.4.1 *Hard-Ceiling Mount* section to remove the housing cover, thread lock and back cover, and take out the camera body.
2. Cut out a circle with a diameter of 142 mm on the ceiling.
3. Insert a blue screw to the indicated holes on the camera body.



Figure 13-9

4. Screw in a plastic clip to the blue screw, hold it with one hand and use a screw driver to rotate the blue screw until the plastic clip moves half way down.

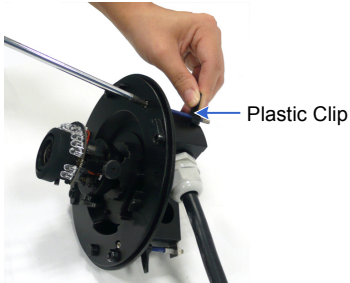

*Figure 13-10*

5. Secure a T-cap on top of the blue screw with a small screw cap and a T-cap screw. Do not tighten the small screw cap so that the plastic clip can move down freely.

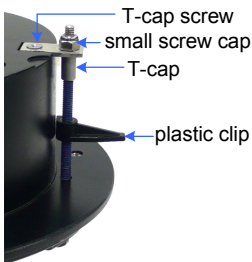

*Figure 13-11*

6. Repeat steps 4 and 5 for the other two blue screws.

7. Insert the camera to the ceiling with the plastic screws moved inward.



*Figure 13-12*

8. Move the blue screws out and rotate the blue screw with a screw driver until the plastic clip and the bottom of the camera body clamps the ceiling tightly.



*Figure 13-13*

9. Connect the network, power and other cables to the camera. See *13.5 Connecting the Camera*.
10. Access the live view. See *18.1 Accessing the Live View*.
11. Follow steps 9 to 10 in *13.4.1 Hard-Ceiling Mount* section to adjust the angle, focus and zoom of the camera.
12. Follow steps 11 to 13 in *13.4.1 Hard-Ceiling Mount* section to secure the thread lock, replace the silica gel bag and secure the housing cover.

## 13.5 Connecting the Camera

Connect your Vandal Proof IP Dome to power, network and other cables needed.

### 13.5.1 Wire Definition

The cables of Vandal Proof IP Dome are illustrated and defined below.

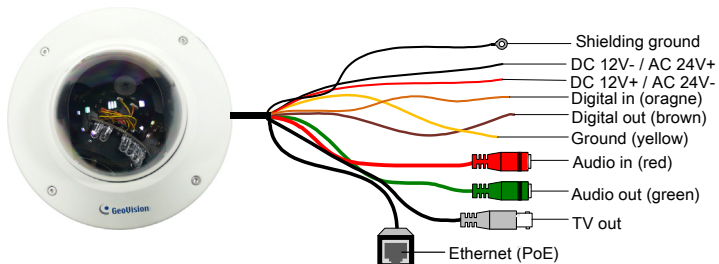

Figure 13-14

No.	Wire Color	Definition
1	Black (thick)	Shielding Ground
2	Black (thin)	DC 12V+ / AC 24V+
3	Red	DC 12V- / AC 24V-
4	Orange	Digital In
5	Brown	Digital out
6	Yellow	Ground
7	Red RCA	Audio in
8	Green RCA	Audio out
9	Black BNC	TV out

**Note:** To use the TV out function, connect the black BNC connector to a monitor and select your signal format (NTSC or PAL) at the **TV Out** field on the Web interface. For details, see [20.1.1 Video Settings](#).

### 13.5.2 Power Connection

There are two ways to supply power to the camera:

- Use a Power over Ethernet (PoE) adapter to connect the camera to the network, and the power will be provided at the same time.
  - Plug the power adapter to the 12V terminal block as shown below. The power adapter is an optional device. For detail, see *Options* in the manual.
1. Insert the thin black wire of the Vandal Proof IP Dome to the left pin and the red wire to the right pin.

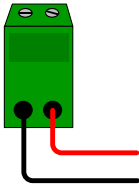

Figure 13-15

2. Connect the DC 12V Power Adapter to the Terminal Block.



Figure 13-16



### 13.5.3 Voltage Load Expansion (Optional)

The camera can only drive a maximum load of **200mA 5V DC**. To expand the maximum voltage load to **10A 250V AC**, **10A 125V AC** or **5A 100V DC**, connect the camera to a GV-Relay V2 module (optional product). Refer to the figure and table below.

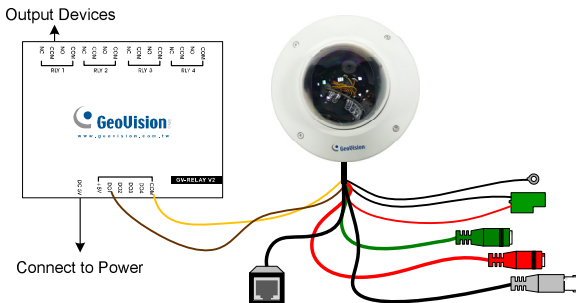

Figure 13-17

GV-Relay V2	Vandal Proof IP Dome
COM	Ground (Yellow)
DO1	Digital Out (Brown)

# Chapter 14 Vandal Proof IP Dome

## (Part II)

This chapter describes the features, physical overview and installation of GV-VD1530 / 2430 / 2530 / 3430, GV-VD1540 / 2440 / 2540 / 3440 / 5340 and GV-VD2540-E / 5340-E.

These Vandal Proof IP Domes are outdoor cameras designed with IK10+ vandal resistance and IP67 ingress protection. They provide superior night vision with their high power LEDs and allow up to 20 m (65.6 ft), 25 m (82 ft) or 30 m (98.4 ft) effective IR distance. The super low lux models are able to display color live view in dear darkness. The WDR Pro models can process scenes with contrasting intensity of lights (see *2.2.1 Wide Dynamic Range Pro* for details). The motorized varifocal models support remote focus and zoom adjustment. The arctic models can withstand extreme temperatures. For related models, see *14.2 Features*.

These Vandal Proof IP Domes can be installed on the ceiling using the standard package. They can also be installed on wall surfaces, wall corners and poles using the GV-Mount accessories (optional). For more details, see *GV-Mount Accessories Installation Guide* on the Software CD.

Model No.		Specification	Description
GV-VD1530 GV-VD2430 GV-VD2530 GV-VD3430 (Coming)	Varifocal lens		1.3 MP Super Low Lux / 2 MP WDR Pro / 2 MP Super Low Lux / 3 MP WDR Pro, H.264, Vandal Proof IP Dome
GV-VD1540 GV-VD2440 GV-VD2540 GV-VD3440	Motorized varifocal lens, high power IR LEDs	Auto Iris, f:3 ~ 9 mm, F/1.2, 1/2.7" $\varnothing$ 14 mm lens mount	1.3 MP Super Low Lux / 2 MP WDR Pro / 2 MP Super Low Lux / 3 MP WDR Pro, H.264, Vandal Proof IP Dome
GV-VD2540-E	Motorized varifocal lens, high power IR LEDs, extreme temperature tolerance		2 MP Super Low Lux, H.264, Vandal Proof IP Dome
GV-VD5340	Motorized Varifocal Lens, high power IR LEDs	Auto Iris, f: 3.3 ~ 9 mm, F/1.2, 1/2.7" $\varnothing$ 14 mm lens mount	5 MP, H.264, Vandal Proof IP Dome
GV-VD5340-E	Motorized varifocal Lens, high power IR LEDs, extreme temperature tolerance		

## 14.1 Packing List

- Vandal Proof IP Dome

- 3-Pin Terminal Block



- Power Adapter



- RJ-45 Connector x 2



- Torx Wrench



- Audio wires



- TV out wire



- Back Plate



- Installation sticker

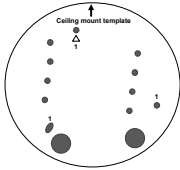

- Screw Anchor x 4



- Long Screw x 4



- Flat Screw



- Short Screw x 2



- Silica Gel Bag x 2

- Sticker (for Silica Gel Bag)

- Ruler

- Conduit Converter



- GV-IPCAM H.264 Software CD

- GV-IPCAM H.264 Quick Start Guide

- GV-NVR Software DVD

- GV-NVR Quick Start Guide

---

**Note:**

1. Power adapter can be purchased upon request.
2. You can choose to run the wires through a conduit pipe. After you have threaded all the wires, install the supplied conduit converter with a self-prepared PG21 conduit connector and conduit pipe (of 1/2", 3/4" or 1") to the camera. Do not use a 1/2" pipe if you use the power adapter for power supply because the adapter can not be thread through.

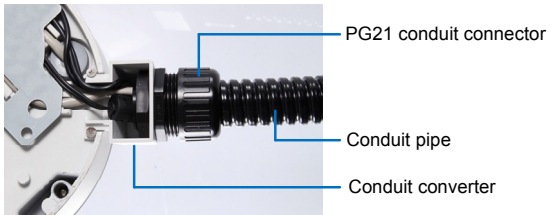

## 14.2 Features

- Image sensor

Camera Model	Image Sensor
GV-VD1530 / 1540	1/3" progressive scan super low lux CMOS
GV-VD2430 / 2440 GV-VD3430 / 3440	1/3.2" progressive scan CMOS
GV-VD2530 / 2540 GV-VD2540-E	1/2.8" progressive scan super low lux CMOS
GV-VD5340 GV-VD5340-E	1/2.5" progressive scan CMOS

- Minimum illumination at 0.01 lux (GV-VD1530 / 1540 / 1540-E)
- Dual streams from H.264 or MJPEG
- Frame rate

Camera Model	Frame Rate
GV-VD1530 / 1540	Up to 30 fps at 1280 x 1024
GV-VD2430 / 2440 GV-VD2530 / 2540 GV-VD2540-E	Up to 30 fps at 1920 x 1080
GV-VD3430 / 3440	Up to 20 fps at 2048 x 1536
GV-VD5340 GV-VD5340-E	Up to 10 fps at 2560 x 1920

- Day and night function (with removable IR-cut filter)
- Intelligent IR
- External high-power IR LEDs
- Wide Dynamic Range Pro (for GV-VD2430 / 2440 / 2440-E / 3430 / 3440 / 3440-E)
- Motorized varifocal lens for remote focus/zoom adjustment (GV-VD1540 / 1540-E / 2440 / 2440-E / 2540 / 2540-E / 3440 / 3440-E / 5340 / 5340-E)
- Defog
- Vandal resistance (IK10+)

- Ingress protection (IP67 rating)
- Wide temperature tolerance: -40°C ~ 50°C / -40°F ~ 122°F  
(for GV-VD2540-E / 5340-E)
- 3-axis mechanism (pan / tilt / roll)
- Micro SD card slot (SD/SDHC) for local storage
- Two-way audio
- One sensor input and alarm output
- TV-out support
- Motion detection
- Tampering alarm
- Visual automation
- Text overlay
- Privacy mask
- IP address filtering
- DC 12V / AC 24V / PoE
- Megapixel lens
- Support for iPhone, iPad, Android and 3GPP
- 31 languages on Web interface
- ONVIF (Profile S) conformant



## 14.3 Overview



Figure 14-1

No.	Name	Description
1	LED Indicators	The power LED (top) turns on (green) when the power is on and turns off when there is no power supply. The status LED (bottom) turns on (green) when the system operates normally and turns off when system error occurs.
2	Audio In	Connects to a microphone for audio output.
3	LAN / PoE	Connects to a 10/100 Ethernet or PoE.
4	Default Button	Resets to factory default. For details, see <i>22.3 Restoring to Factory Default Settings</i> .
5	Video Out	Connects to a portable monitor for setting the focus and angle of the camera during initial setup.
6	Memory Card Slot	Inserts a micro SD card (SD/SDHC, version 2.0 only, Class 10) to store recording data.
7	Audio Out	Connects to a speaker for audio output.
8	DC 12V / AC 24V	Connects to power.
9	I/O Terminal Block	Connects to an I/O device.
10	Rotational Screw	Loosens to rotate the camera.
11	Cable seal	Waterproofs the Internet cable.
12	Tilt Screw	Loosen the screw to tilt the camera.
13	Conduit Connector	Waterproofs the audio, TV out, power adapter and I/O wires.
14	Silica Gel Bag	Absorbs moisture in the camera body.

## 14.4 Installation

The Vandal Proof IP Dome is designed for outdoors. With the standard package, you can install the camera on the ceiling.

---

**Note:** The standard package allows you to install the camera to the power box of 4" square and double gang. You may also install the camera to ceilings, wall surfaces, wall corners (concave or convex), and poles with optional mounting kits. For more details, see *GV-Mount Accessories Installation Guide* on the Software CD.

---

---

**IMPORTANT:** When installing the Vandal Proof IP Dome near the corner, maintain at least 25 cm away from the walls to avoid reflection problems.

---

1. Remove the housing cover with the supplied torx wrench.
2. Thread wires into the camera.
  - A. Unscrew the conduit connector from the back.

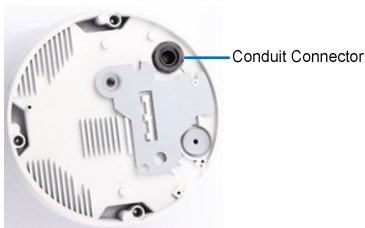

*Figure 14-2*

- B. Unplug the conduit connector inside the housing and disintegrate the connector. You should have 4 parts:



*Figure 14-3*

- C. Remove the terminal block from the power adapter.
- D. Thread the audio wires (optional), TV out wire (optional), adapter wires and I/O wires (optional) through the conduit entry and then through part 1, 2, 3 and 4 of the conduit connector.

---

**Tip:**

1. To make the threading easier, it is advised to thread the wires in the order described here.
2. Use a pair of pliers to help you pull the wires through the camera.
3. Use the supplied ruler and leave adequate length for wires inside the camera housing. The length described below does not include the connector part.

<b>Wires</b>	<b>Length Inside Housing</b>
I/O, power	10 cm
Audio, TV out, LAN/PoE	11 cm

---

For part 2, there are 8 holes each labeled with its diameter. Remove the plugs and push the wires to the corresponding hole listed below:

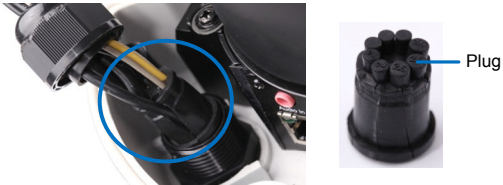

Figure 14-4

Hole Diameter	Applied to
2.6 mm	Audio in and audio out TV out wire
2 mm	Adapter wires
1.8 mm	I/O wires

- E. Push off the cable seal in the indicated direction. Thread an Internet cable (with RJ-45 connector only on one end) through the cable seal and re-install the cable seal.

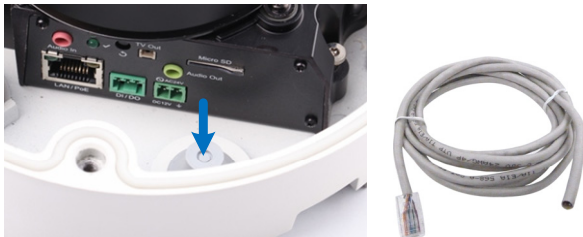

Figure 14-5

3. Connect the wires to the camera.
  - A. Install the terminal blocks to the power adapter and I/O devices. See 14.5.1 *Power Connection* and 14.5.2 *I/O Device Connections*.
  - B. Install the supplied RJ-45 connector to the Internet cable.
  - C. Plug all the connectors to the camera panel.

---

**Tip:** Unscrew the indicated screws and lift the camera to help you connect the wires.

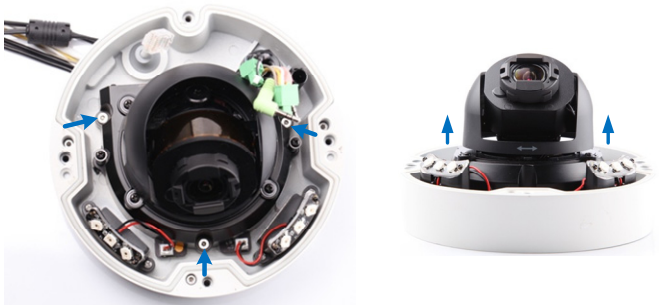

Figure 14-6

- D. Arrange the wires in the conduit connector and re-install it to the camera.

- Sort out the wires at the back. You can have the wires come out from position A, B or both. The instructions here describe sorting wires for position A.



Figure 14-7

From the back of the camera housing, unscrew and rotate the plate to one side, sort out the wires and secure the plate back.



Figure 14-8

5. Secure the back plate to the ceiling.
  - A. Paste the sticker to the ceiling. The arrow on the sticker indicates the direction that the camera faces.

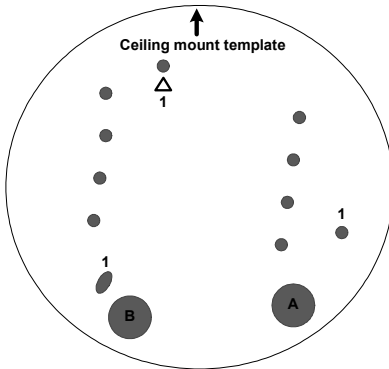
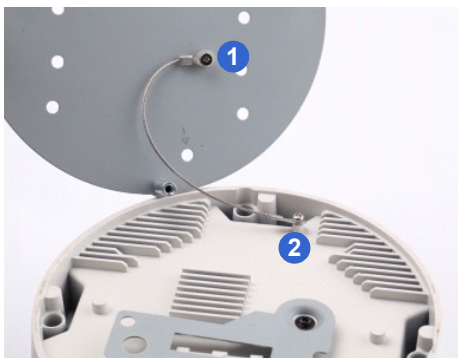

*Figure 14-9*

- B. Drill 3 holes for screws. The recommended ones are indicated as '1'.
- C. Insert the screw anchors to the 3 holes.
- D. Depending on how you want to run the wires (see step 4). Drill the right hole (Figure 14-10) for position A and the left for position B or both if required.
- E. Secure the back plate to the ceiling with long screws.



6. Secure the camera to the ceiling.
  - A. Secure the safety lock to the camera using a short screw. Use flat screw for number 1 and small screw for number 2.



*Figure 14-10*

- B. Thread all the wires into the ceiling and connect them.

---

**Note:** To use the TV out function, connect the black BNC connector to a monitor and select your signal format (NTSC or PAL) at the **TV Out** field on the Web interface. For details, see [20.1.1 Video Settings](#).

---

- C. Secure the camera using the torx wrench

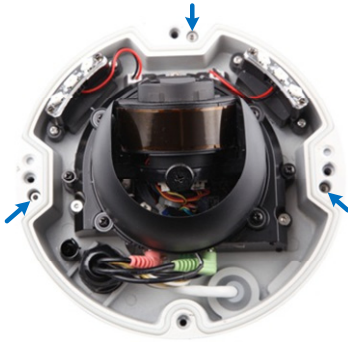

*Figure 14-11*

7. Access the live view. See [18.1 Accessing the Live View](#).
8. Adjust the camera's angle, focus and zoom of the camera.

**Pan Adjustment**



*Figure 14-12*

### Tilt Adjustment



*Figure 14-13*

### Rotational Adjustment



*Figure 14-14*

9. Replace the silica gel bag and secure the camera cover using the torx wrench.

---

**IMPORTANT:**

1. The gel bag loses its effectiveness when the dry camera is opened. To prevent the lens from fogging up, replace the silica gel bag every time you open the camera and conceal the silica gel bag within 2 minutes of exposing to open air.
2. For each newly replaced silica gel bag, allow it to absorb moisture for at least 5 hours before operating the camera.
3. Make sure the housing cover is properly secured to prevent water from entering and damaging the inner housing.
4. If the center of the camera view is less than  $25^\circ$  to the ceiling, or lower than the grey line (as illustrated below), disassemble the indicated ring so the view is not obstructed. However, with the ring disassembled, slight reflections may occur.



## 14.5 Connecting the Camera

Connect your Vandal Proof IP Dome to power, network and other wires needed.

### 14.5.1 Power Connection

There are two ways to supply power to the camera:

- Use a Power over Ethernet (PoE) adapter to connect the camera to the network, and the power will be provided at the same time.
- Plug the power adapter to the terminal block by inserting the wire with white lines to the right pin and the other wire to the left pin. The power adapter is an optional device. For detail, see *Options* in the manual.

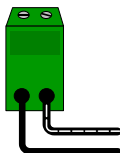

Figure 14-15

### 14.5.2 I/O Device Connections

The Box Camera support one digital input and one digital output of dry contact.

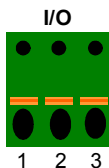

Figure 14-16

Pin	Function
1	Digital Output
2	GND
3	Digital Input

For details on how to enable an installed I/O device, see *20.2 I/O Settings*.

### 14.5.3 Voltage Load Expansion (Optional)

The camera can only drive a maximum load of **200mA 5V DC**. To expand the maximum voltage load to **10A 250V AC**, **10A 125V AC** or **5A 100V DC**, connect the camera to a GV-Relay V2 module (optional product). Refer to the figure and table below.

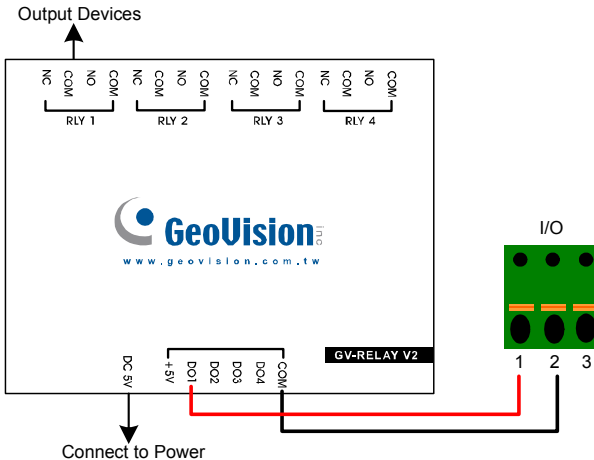

Figure 14-17

GV-Relay V2	Vandal Proof IP Dome
COM	Pin 2 of I/O terminal block
DO1	Pin 1 of I/O terminal block

## Chapter 15 Fixed IP Dome

The Fixed IP Dome is a series of indoor camera designed with 3-axis mechanism for easy and flexible installation. The Fixed IP Dome features IR LED for infrared illumination for night surveillance. The WDR Pro models can produce clear image for scenes containing contrasting intensity of lights (see 2.2.1 *Wide Dynamic Range Pro* for details). The motorized varifocal lens models allow the user to remotely adjust the zoom and focus through the Web interface. The super low lux models are able to display color live view in near darkness. For related models, see 15.2 *Features*. The models are detailed below:

Model No.		Specification	Description
GV-FD120D GV-FD220D GV-FD320D	Varifocal Lens	Auto Iris, f:3 ~ 9 mm, F/1.3, 1/3" $\varnothing$ 14 mm lens mount	1.3 MP Low Lux / 2 MP / 3 MP, H.264, D/N, Fixed IP Dome
GV-FD1200			1.3 MP Low Lux, H.264, D/N, Fixed IP Dome
GV-FD1500 GV-FD2500		Auto Iris, f: 3 ~ 9 mm, F/1.2, 1/2.7" $\varnothing$ 14 mm Mount	1.3 MP / 2 MP Super Low Lux, H.264, D/N, Fixed IP Dome
GV-FD2400 GV-FD3400			2 MP / 3 MP, H.264, D/N, WDR Pro, Fixed IP Dome
GV-FD5300		Auto Iris, f: 4.5 ~ 10 mm, F/1.6, 1/2.5" CS Mount	5 MP, H.264, D/N, Fixed IP Dome

Model No.		Specification	Description
GV-FD1210	Motorized varifocal Lens	Auto Iris, f: 3 ~ 9 mm, F/1.2, 1/2.7" $\varnothing$ 14 mm Mount	1.3 MP Low Lux, H.264, D/N, 3x Optical Zoom, Fixed IP Dome
GV-FD1510 GV-FD2510			1.3 MP / 2 MP Super Low Lux, H.264, D/N, 3x Optical Zoom, Fixed IP Dome
GV-FD2410 GV-FD3410			2 MP / 3 MP, H.264, D/N, WDR Pro, 3x Optical Zoom, Fixed IP Dome



## 15.1 Packing List

### 15.1.1 Packing List for Hard-Ceiling Mount

- Fixed IP Dome



- Torx Wrench



- Mounting Plate



- Short Screw Anchor x 3



- Ceiling Screw x 3



- Plate Screw x 3



- TV-out Wire



- Sticker

- GV-IPCAM H.264 Software CD

- GV-IPCAM H.264 Quick Start Guide

- GV-NVR Software DVD

- GV-NVR Quick Start Guide

---

**Note:** Power adapter can be purchased upon request.

---

## 15.1.2 Packing List for In-Ceiling Mount

- In-Ceiling Housing Cover



- Mounting Plate



- Mounting Bracket x 3



- Copper Pillar x 3



- Copper Pillar Screw x 6



- Bracket Screw x 3



- Thread Lock Screw



- Housing Cover Thread

- Sticker (In-Ceiling Mount)

## 15.2 Features

- Image sensor

Camera Model	Image Sensor
GV-FD120D GV-FD1200 / 1210	1/3" progressive scan low lux CMOS
GV-FD1500 / 1510	1/3" progressive scan super low lux CMOS
GV-FD2500 / 2510	1/2.8" progressive scan super low lux CMOS
GV-FD2400 / 2410 GV-FD3400 / 3410	1/3.2" progressive scan CMOS
GV-FD220D GV-FD320D GV-FD5300	1/2.5" progressive scan CMOS

- Dual streams from H.264 or MJPEG
- Frame rate

Camera Model	Frame Rate
GV-FD120D GV-FD1200 / 1210 GV-FD1500 / 1510	30 fps at 1280 x 1024
GV-FD220D GV-FD2400 / 2410 GV-FD2500 / 2510	30 fps at 1920 x 1080
GV-FD320D GV-FD3400 / 3410	20 fps at 2048 x 1536
GV-FD5300	10 fps at 2560 x 1920

- Day and night function (with removable IR-cut filter)
- Wide Dynamic Range Pro (for GV-FD2400 / 2410 / 3400 / 3410 only)
- Defog

- 3-axis mechanism (pan / tilt / roll)
- Built-in IR LED
- Micro SD card slot (SD/SDHC) for local storage
- Two-way audio
- One sensor input and alarm output
- TV-out support
- Motion detection
- Tampering alarm
- Visual automation
- Text overlay
- Privacy mask
- IP address filtering
- DC 12V / AC 24V / PoE
- Megapixel lens
- Support for iPhone, iPad, Android and 3GPP
- 31 languages on Web interface
- ONVIF (Profile S) conformant

## 15.3 Overview

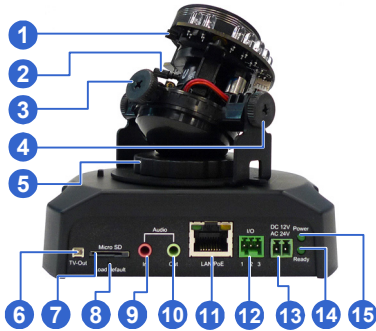

Figure 15-1

No.	Name	Description
1	Focus Screw	Adjusts the focus of the camera.
2	Zoom Screw	Adjusts the zoom of the camera.
3	Rotational Screw	Loosens to adjust the camera angle.
4	Tilt Screw	Loosens the screw to tilt the camera.
5	Pan Disc	Loosens to pan the camera.
6	Video Out	Connects to a portable monitor for setting the focus and angle of Fixed IP Dome during initial installation.
7	Memory Card Slot	Inserts a micro SD card (SD/SDHC, version 2.0, Class 10) to store recording data.
8	Default Button	Resets to factory default. For details, see <i>19.3. Restoring to Factory Default Settings</i> .

No.	Name	Description
9	Audio In	Connects a microphone for audio input.
10	Audio Out	Connects a speaker for audio output.
11	LAN / PoE	Connects to a 10/100 Ethernet or PoE.
12	I/O Terminal Block	Connects I/O devices. For details, see <i>12.6 I/O Terminal Block</i> .
13	DC 12V Port	Connects to power.
14	Status LED	Turns on (green) when the system operates normally and turns off when system error occurs.
15	Power LED	Turns on (green) when the power is on and turns off when there is no power supply.

## 15.4 Installation

The Fixed IP Dome is designed for indoors. With the standard packing, there are three ways to install the Fixed IP Dome: **hard-ceiling mount**, **in-ceiling mount** and **wall-surface mount**.

---

**Note:** You may also install the camera to ceilings, wall corners (concave or convex), and poles with optional mounting kits. For details, see *GV-Mount Accessories Installation Guide* on the Software CD.

---

### 15.4.1 Hard-Ceiling Mount



*Figure 15-2*

1. Paste the supplied sticker onto a desired location on the ceiling. Drill the three red dots and the ellipse mark only if you wish to run the wires into the ceiling.

2. Unpack the camera package and take out the camera body.
  - A. Use the torx wrench to loosen the housing cover at the front and the back.



*Figure 15-3*

- B. Take out the camera body



*Figure 15-4*

3. Secure the camera body to the mounting plate with three ceiling screws.

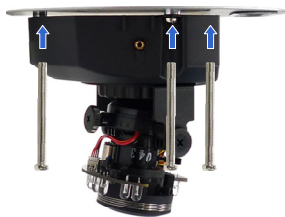

*Figure 15-5*



4. Connect the network, power and other cables to the camera. See *15.5 Connecting the Camera*.
5. Access the live view. See *18.1 Accessing the Live View*.
6. Based on the live view, adjust the camera to a desired angle as illustrated below.

---

**Tip:** The 3-axis mechanism offers flexible and easy ceiling / wall installation.

---

### Pan Adjustment



*Figure 15-6*

### Tilt Adjustment



*Figure 15-7*

## Rotational Adjustment



Figure 15-8

7. Adjust image clarity using the GV-IP Device Utility program. For details, see [18.2 Adjusting Image Clarity](#).
8. Secure the housing cover as shown in step 2. Remove the indicated part when necessary.



Figure 15-9

---

**Note:** Adjust the black mask inside the housing cover to make sure the camera view is not obscured.

---

## 15.4.2 In-Ceiling Mount



Figure 15-10

1. Follow step 2 in the *15.4.1 Hard-Ceiling Mount* to remove the housing cover and take out the camera body.
2. Paste the supplied sticker onto a desired location on the ceiling and cut a circle on the ceiling along the edge of the sticker.
3. On the mounting plate, locate the 3 holes labeled as 1 and insert the 3 copper pillars from the back side.



Figure 15-11

- From the side with the numbering, secure the copper pillars with 3 copper pillar screws.

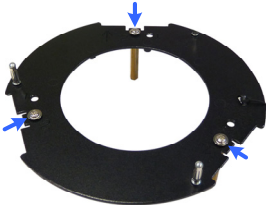

Figure 15-12

- Place the 3 mounting brackets at the indent next to the copper pillars (labeled as 2 on the mounting plate) and secure them using the 3 bracket screws.

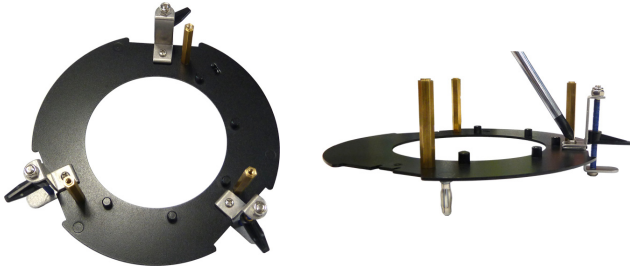
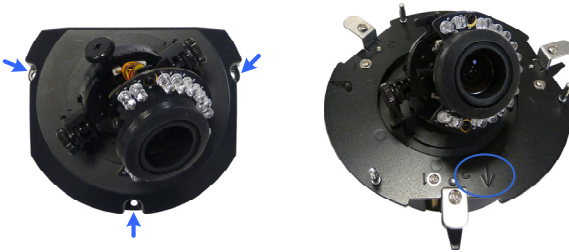

Figure 15-13

6. Place the mounting plate on the camera body with the copper pillars inserted in the locations indicated below. The arrow on the mounting plate should be pointing toward the front of the camera.



*Figure 15-14*

7. From the bottom of the camera, secure the copper pillars using the 3 copper pillars screws.
8. Place the camera into the ceiling opening.
9. On the back side, make sure the black plastic clips are slightly above the ceiling board and pointing outward.

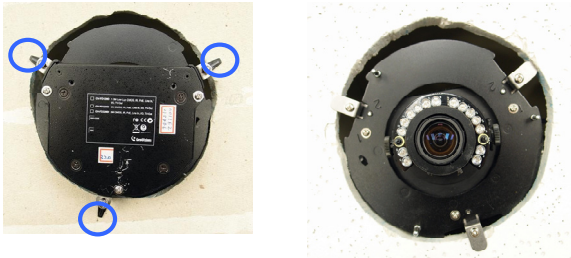

Back Side

Front Side

*Figure 15-15*

10. Tighten the bracket screws from the front side of the camera.

11. Connect the network, power and other cables to the camera. See *15.5 Connecting the Camera*.
12. Access the live view. See *18.1 Accessing the Live View*.
13. Follow steps 6 and 7 in *15.4.1 Hard-Ceiling Mount* section to adjust the angle, focus and zoom of the camera.
14. Use the housing cover thread and the thread lock screw to attach the housing cover to the camera body.



*Figure 15-16*

15. Place the housing cover on the camera body with the GeoVision logo pointing toward the front of the camera.



*Figure 15-17*

### 15.4.3 Wall-Surface Mount



*Figure 15-18*

1. Follow step 2 in 15.4.1 *Hard-Ceiling Mount* section to remove the housing cover and take out the camera body.
2. Paste the supplied sticker onto a desired location on the wall. Drill the three red dots, and the ellipse mark only if you wish to run the wires into the wall.
3. Insert the short screw anchors and secure the camera and the mounting plate with three plate screws.

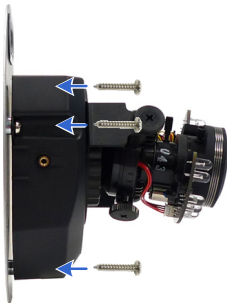

*Figure 15-19*

4. Connect the network, power and other cables to the camera. See 15.5 *Connecting the Camera*.

5. Access the live view. See *18.1 Accessing the Live View*.
6. Follow steps 6 and 7 in *15.4.1 Hard-Ceiling Mount* section to adjust the angle, focus and zoom of the camera.
7. Follow step 8 in *15.4.1 Hard-Ceiling Mount* section to secure the housing cover.



## 15.5 Connecting the Camera



Figure 15-20

1. Use a standard network cable to connect the camera to your network.
2. Optionally connect a speaker and an external microphone.
3. Optionally connect a monitor using a Video Out wire. Enable this function by selecting your signal format at the **TV Out** field on the Web interface. See *20.1.1 Video Settings*.
4. Optionally connect to input / output devices. For details, see *15.6 I/O Terminal Block*.
5. Connect power using one of the following methods:
  - plugging the power adapter to power port. The power adapter is an optional device. For detail, see *Options* in the manual.
  - using the Power over Ethernet (PoE) function and the power will be provided over the network cable.
6. The status LED of the camera will be on.

## 15.6 I/O Terminal Block

The terminal block, located on the back panel of the Fixed IP Dome, provides the interface to one input and one output devices. The I/O terminal block can be used for applications such as motion detection, event alerts via E-Mail and FTP, and center monitoring through Center V2 and VSM.

### 15.6.1 Pin Assignment

The Fixed IP Dome supports one digital input and one digital output of dry contact.

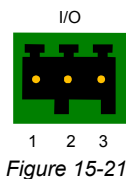

Figure 15-21

Pin	Function
1	Digital Output
2	GND
3	Digital Input

## 15.6.2 Voltage Load Expansion (Optional)

The camera on its own can only drive a maximum load of **200mA 5V DC**. To expand the maximum voltage load to **10A 250V AC / 10A 125V AC / 5A 100V DC**, connect the camera to a GV-Relay V2 module (optional product). Refer to the figure and table below:

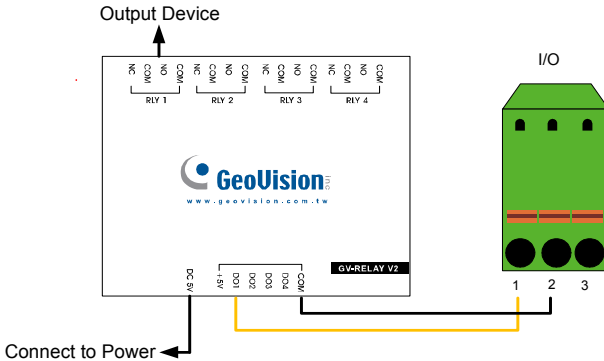

Figure 15-22

GV-Relay V2	Bullet Camera
COM	Pin 2 (GND)
DO1	Pin 1 (Digital Output)

## Chapter 16 Cube Camera

The Cube Camera is a light weighted wired / wireless network camera designed for indoor usage. Its simple design allows for fast and easy installation and fixed-spot surveillance once installed. Four models are available:

Model No.		Specification	Description
GV-CB120	Fixed Lens	Fixed Iris, f: 3.35 mm, F/2.4, 1/3" M12 mm lens mount	1.3 MP, H.264, Cube Camera
GV-CB220			2 MP, H.264, Cube Camera
GV-CBW120			1.3 MP, H.264, Wireless Cube Camera
GV-CBW220			2 MP, H.264, Wireless Cube Camera

## 16.1 Packing List

- Cube Camera



- Supporting Rack



- Screw x 3



- GV-IPCAM H.264 Quick Start Guide

- GV-NVR Quick Start Guide

- Screw Anchor x 3



- GV-IPCAM H.264 Software CD

- GV-NVR Software DVD

---

**Note:** Power adapter can be purchased upon request.

---

## 16.2 Features

- 1/2.5" progressive scan CMOS
- Dual streams from H.264 or MJPEG
- Frame rate

Camera Model	Frame Rate
GV-CB120 / CBW120 Series	30 fps at 1280 x 1024
GV-CB220 / CBW220 Series	30 fps at 1920 x 1080

- Day and night function (electronic)
- Wide Dynamic Range (WDR)
- Defog
- Wireless connectivity: WiFi 802.11b/g/n (for GV-CBW120 / 220 only)
- Two-way audio
- Micro SD card slot (SD/SDHC) for local storage
- Motion detection
- Tampering alarm
- Text overlay
- Privacy mask
- IP address filtering
- Megapixel lens
- Support for iPhone, iPad, Android and 3GPP
- 31 languages on Web interface
- ONVIF (Profile S) conformant

## 16.3 Overview

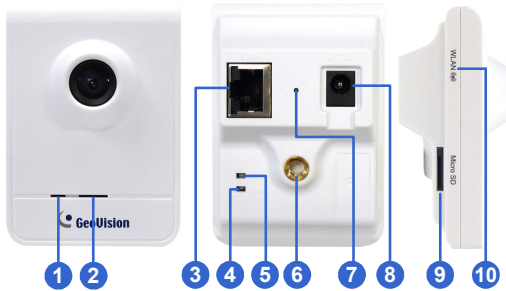

Figure 16-1

No.	Name	Description
1	Microphone	Receives sounds.
2	Speaker	Plays sounds.
3	LAN	Connects to a 10/100 Ethernet.
4	Status LED	Turns red when the system powers on. Turns orange when the system is ready.
5	LAN LED	Turns green when the camera is connected to the Internet through wires. Turns blue when wireless service is enabled (for GV-CBW120 / 220 only).
6	Stand screw	Connects to the Supporting Rack.
7	Default Button	Resets to factory default. For details, see <i>22.3. Restoring to Factory Default Settings</i> .
8	Power port	Connects to the power adapter.
9	Memory Card Slot	Inserts a micro SD card (SD/SDHC, version 2.0 only, Class 10) to store recording data.
10.	Wireless LAN Receiver	Indicates that the camera supports wireless connection (for GV-CBW120/220 only).

## 16.4 Installation

Follow the steps below to install, connect to and adjust your Cube Camera and Wireless Cube Camera.

1. Put the supporting rack on the desired location and make marks for screw anchors.

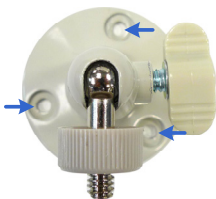

Figure 16-2

2. Drill the marks and insert the screw anchors.
3. Secure the supporting rack onto the wall using the supplied screws.
4. Screw the camera onto the supporting rack and fasten the indicated screw.



Figure 16-3



5. Connect the network and power cables to the camera. See *16.5 Connecting the Camera*.
6. Access the live view. See *18.1 Accessing the Live View*.
7. Adjust the angle of the camera based on live view and fasten the indicated screw.



*Figure 16-4*

8. For GV-CBW120/220, to connect to the Internet through wireless service, follow the steps in *18.1.3 Configuring the Wireless Connection*.

## 16.5 Connecting the Camera



Figure 16-5

1. Use a standard network cable to connect the camera to your network.
2. Power on using the power adapter. The power adapter is an optional device. For detail, see *Options* in the manual.
3. The status LED of the camera will be orange.

---

**IMPORTANT:** Be sure to use the GeoVision power adapter to power up the camera. To use your own power cable, make sure you look up the power source value indicated at the camera's back panel.

---

# Chapter 17 Advanced Cube Camera

The Advanced Cube Camera integrates the passive infrared (PIR) sensor and the alarm LED to illuminate the scene automatically when the motion is detected. It also offers wireless connection to the network for flexible installation. It is small, light, and easy-to-use for indoor security. We provide four models:

Model No.		Specification	Description
GV-CA120	Fixed Lens	Fixed Iris, f: 3.35 mm, F/2.4, 1/3" M12 mm lens mount	1.3 MP, H.264, Cube Camera
GV-CA220			2 MP, H.264, Cube Camera
GV-CAW120			1.3 MP, H.264, Wireless Cube Camera
GV-CAW220			2 MP, H.264, Wireless Cube Camera

## 17.1 Packing List

- Advanced Cube Camera



- Supporting Rack



- Screw x 3



- Screw Anchor x 3



- GV-IPCAM H.264 Quick Start Guide

- GV-IPCAM H.264 Software CD

- GV-NVR Quick Start Guide

- GV-NVR Software DVD

---

**Note:** Power adapter can be purchased upon request.

---

## 17.2 Features

- 1/2.5" progressive scan CMOS
- Dual streams from H.264 or MJPEG
- Frame rate

Camera Model	Frame Rate
GV-CA120 / CAW120	30 fps at 1280 x 1024
GV-CA220 / CAW220	30 fps at 1920 x 1080

- Micro SD card slot (SD/SDHC) for local storage
- Passive infrared (PIR) sensor for detecting movement and activating the white illumination LED
- DC 5V / PoE (PoE is for GV-CA120 / 220 only)
- Day and night function (electronic)
- Wide Dynamic Range (WDR)
- Defog
- Wireless connectivity: WiFi 802.11b/g/n (for GV-CAW120 / 220 only)
- Two-way audio
- Motion detection
- Tampering alarm
- Text overlay
- Privacy mask
- IP address filtering
- Megapixel lens
- Smart device access
- 31 languages on Web interface
- ONVIF (Profile S) conformant

## 17.3 Overview



Figure 17-1









No.	Name	Description
1	Speaker	Plays sounds for tampering and motion alarm, and listens to the audio around the camera. To set up alarm sound, see 20.3.9 <i>Speaker</i> .
2	PIR sensor	Passive infrared sensor.
3	Microphone	Receives sounds.
4	White Illumination LED	When the PIR sensor detects the movement, the white illumination LED lights up in a low light scene. To set up the LED, see 20.1.1 <i>Video Settings</i> .
5	Monitoring LED	Reflects monitoring status of the camera. See the below table.
6	Live View LED	Reflects live view status of the camera. See the below table.
7	LAN / PoE	Connects to a 10/100 Ethernet or PoE.
8	Stand screw	Connects to the Supporting Rack.
9	Power port	Connects to the power adapter.

No.	Name	Description
10	Ready LED	Reflects system status of the camera. See the below table.
11	LAN LED	Reflects LAN status of the camera. See the below table.
12	Memory Card Slot	Inserts a micro SD card (SD/SDHC, version 2.0 only, Class 10) to store recording data.

---

**IMPORTANT:** The White Illumination LED can reach high temperatures. Be sure not to touch the LED with bare hand.

---

LED		Status	Description
Live View			<ul style="list-style-type: none"> <li>Turns on orange light when you see the live view.</li> </ul>
Monitoring			<ul style="list-style-type: none"> <li>Turns on red light when you start monitoring.</li> </ul>
Ready			<ul style="list-style-type: none"> <li>Turns on green light when the system is ready.</li> <li>Flashes green light when you load default value.</li> </ul>
LAN		 	<ul style="list-style-type: none"> <li>Turns on green light when you connect the LAN Network.</li> <li>Turns on blue light when you connect the Wi-Fi Network (for GV-CAW120 / 220 only).</li> </ul>

## 17.4 Installation

Follow the steps below to install, connect to and adjust your Advanced Cube Camera and Wireless Advanced Cube Camera.

1. Put the supporting rack on the desired location and make marks for screw anchors.



Figure 17-2

2. Drill the marks and insert the screw anchors.
3. Secure the supporting rack onto the wall using the supplied screws.
4. Screw the camera onto the supporting rack and fasten the indicated screw.



Figure 17-3



5. Connect the network and power cables to the camera. See *17.5 Connecting the Camera*.
6. Access the live view. See *18.1 Accessing the Live View*.
7. Adjust the angle of the camera based on live view and fasten the indicated screw.



*Figure 17-4*

8. For GV-CAW120/220, to connect to the Internet through wireless service, follow the steps in *18.1.3 Configuring the Wireless Connection*.

## 17.5 Connecting the Camera



Figure 17-5

1. Use a standard network cable to connect the camera to your network.
2. Connect power using one of the following methods:
  - plugging the power adapter to the power port. The power adapter is an optional device. For detail, see *Options* in the manual.
  - using the Power over Ethernet (PoE) function and the power will be provided over the network cable.
3. When the ready LED of the camera shines green, the camera is ready for use.

---

**Note:** PoE function is only supported for GV-CA120 and GV-CA220.

---

# Chapter 18 Getting Started

This section provides the initial and basic configurations of the GV-IPCAM H.264.

## 18.1 Accessing the Live View

Access or configure your camera according to the camera type and its firmware version:

Camera Type & Firmware Version	Default Connection Type
<ul style="list-style-type: none"><li>● GV-IPCAM H.264 with <b>firmware V1.07 or later</b> (except GV-PTZ010D)</li><li>● Target Series</li></ul>	<p><b>DHCP</b></p> <p>An unused IP address is automatically assigned by the DHCP server to the camera when the camera is connected to the network. Refer to <b>18.1.1 Checking the Dynamic IP Address</b> to look up the IP address.</p> <p>However, if the camera is installed in a LAN without DHCP server, access the camera by its default IP address <b>192.168.0.10</b> and see <b>18.1.2 Configuring the IP Address</b> for more detail.</p>

Camera Type & Firmware Version	Default Connection Type
<ul style="list-style-type: none"><li>● GV-IPCAM H.264 with <b>firmware V1.06 or earlier</b></li><li>● GV-PTZ010D</li></ul>	<p><b>Static</b></p> <p>The default IP address <b>192.168.0.10</b> will be automatically assigned when the camera is connected to the network.</p> <p>To avoid IP conflict with other GeoVision IP devices, it is advisable to re-assign a different IP address. See <b>18.1.2 <i>Configuring the IP Address</i></b> for more detail.</p>

## 18.1.1 Checking the Dynamic IP Address

Follow the steps below to look up the IP address and access the Web interface.

1. Install the GV-IP Device Utility program included on the *GV-IPCAM H.264 Software CD*.

---

**Note:** The PC installed with GV-IP Device Utility must be under the same LAN with the GV-IPCAM H.264 you wish to configure.

---

2. On the GV-IP Utility window, click the  button to search for the IP devices connected in the same LAN. Click the **Name** or **Mac Address** column to sort.

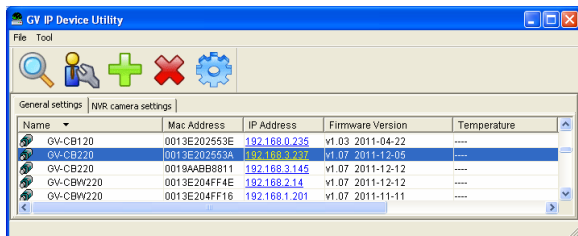

Figure 18-1

- Find the camera with its Mac Address, click on its IP address and select **Web Page**.

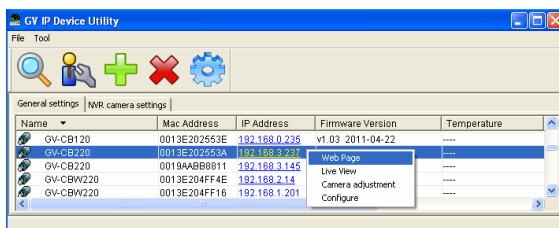

Figure 18-2

- The login page appears.

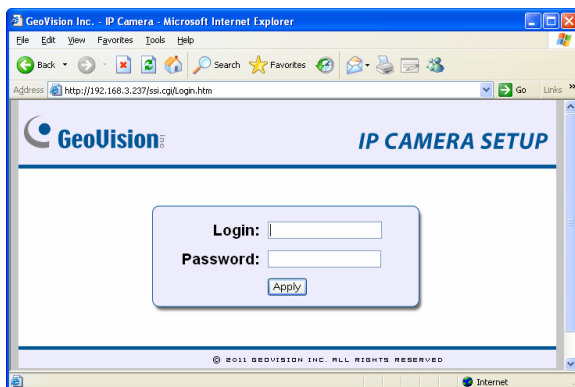

Figure 18-3

- Type the default ID and password **admin** and click **Apply** to log in.

## 18.1.2 Configuring the IP Address

Follow the steps below to configure the IP address.

1. Open your web browser, and type the default IP address <http://192.168.0.10>.
2. In both Login and Password fields, type the default value **admin**. Click **Apply**.
3. In the left menu, select **Network** and then **LAN** to begin the network settings. This page appears.

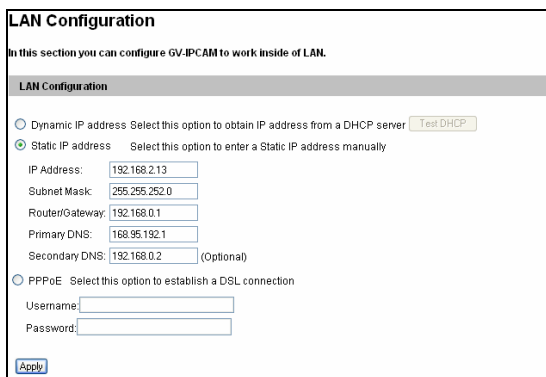

**LAN Configuration**

In this section you can configure GV-IPCAM to work inside of LAN.

**LAN Configuration**

Dynamic IP address Select this option to obtain IP address from a DHCP server

Static IP address Select this option to enter a Static IP address manually

IP Address:

Subnet Mask:

Router/Gateway:

Primary DNS:

Secondary DNS:  (Optional)

PPPoE Select this option to establish a DSL connection

Username:

Password:

Figure 18-4

4. Select **Dynamic IP address**, **Static IP address** or **PPPoE** and type the required network information.
5. Click **Apply**. The camera is now accessible by entering the assigned IP address on the web browser.

---

**IMPORTANT:**

1. If **Dynamic IP Address** or **PPPoE** is enabled, you need to know which IP address the camera will get from DHCP server or ISP to log in. If your camera is installed in the LAN, use the GV-IP Device Utility to look up its current dynamic IP address. See *18.1.1 Checking the Dynamic IP Address*. If your camera uses a public dynamic IP address via PPPoE, use the dynamic DNS Service to obtain a domain name that is linked to the camera's changing IP address first. For details on Dynamic IP Address and PPPoE, see *20.7.1 LAN Configuration* and *20.7.3 Advanced TCP/IP*.
2. If **Dynamic IP Address** or **PPPoE** is enabled and you cannot access the camera, you may have to reset it to the factory default and then perform the network settings again.

To restore the factory settings, see *22.3 Restoring to Factory Default Settings*.

---



### 18.1.3 Configuring the Wireless Connection

You may create wireless connection to the Internet for:

- Box Camera: GV-BX1200 series / 1300 series / 1500 series / 2400 series / 2500 series / 3400 series / 5300 series
  - Wireless Cube Camera: GV-CBW120 / 220
  - Wireless Advanced Cube Camera: GV-CAW120/220
  - Mini Fixed Dome: GV-MFD1501 series / 2401 series / 2501 series / 3401 series / 5301 series
1. To set up the wireless LAN for the first time, power on and connect a standard network cable to the camera.
  2. An IP address will be automatically assigned to the camera. Use GV IP Device Utility to search for the device. For details, see *18.1.1 Checking the Dynamic IP Address*.
  3. Configure the wireless settings.
    - A. On the Web interface, select **Network**, select **Wireless** and **Client Mode**. This dialog box appears.

**WLAN Configuration (Client Mode)**

In this section you can configure your GV-IPCAM to act as Wireless Client.

---

**Wireless Client Setting**

Network name (SSID)

Network type  Ad Hoc  Infrastructure

Authentication Type

WPA-PSK Pre-shared Key

WEP

Key 1 HEX

Key 2 HEX

Key 3 HEX

Key 4 HEX

\* HEX: 10 or 26 hex digits. ASCII: 5 or 13 characters.

Figure 18-5

- B. Type the Network Name (SSID) or click the **Access Point Survey** button to search and select for the available Access Points/wireless stations.
  - C. Select **Ad-Hoc** or **Infrastructure** for the Network type.
  - D. Select the **Authentication Type** using the drop-down list. You can also obtain this information by clicking the **Access Point Survey** button.
  - E. Type the **WPA-PSK Pre-shared Key** or **WEP** depending on the encryption setting for the Access Point.
  - F. Click **Apply** to save the configuration.
- 

**Note:**

1. Your encryption settings must match those used by the Access Points or wireless stations with which you want to associate.
  2. When **Ad Hoc** is used, only **WEP** encryption is supported.
  3. When you lose the wireless access, you can still access the unit by connecting it to a LAN and using the GV IP Device Utility to search for the device.
  4. For detailed information on configuring the wireless LAN, see *20.7.2 Wireless Client Mode*.
-

4. Enable wireless LAN.

- A. On the Web interface, select **Network** and **LAN**. This page appears.

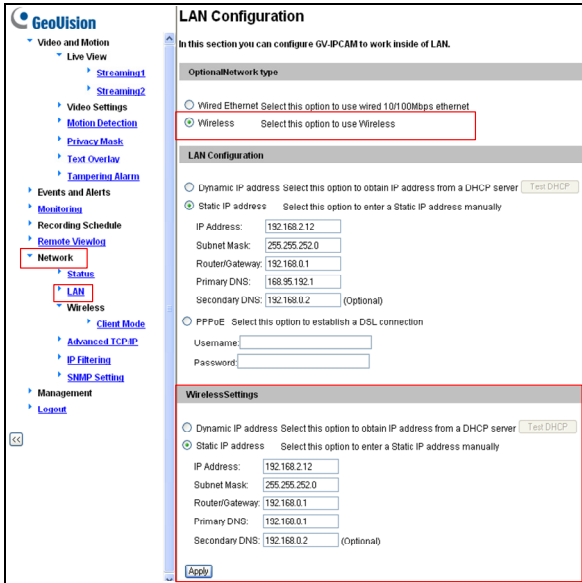

Figure 18-6

- B. Select **Wireless** for Optional Network Type.
- C. To use a dynamic IP address assigned by the DHCP server, select **Dynamic IP address**. To use a fixed IP address, select **Static IP address** and type the IP address information.

5. Click **Apply**. The Camera will start creating a wireless connection to the access point.

---

**Note:** For GV-CBW120/220 and GV-CAW120/220, the LAN LED (No. 5, Figure 16-1; No.11, Figure 17-1) turns blue when the connection is established.

---

6. Unplug the Ethernet cable.

## 18.2 Adjusting Image Clarity

Note the procedures described in this section only apply to **Box Camera, IR Arctic Box Camera, Bullet Camera, PT Camera, Vandal Proof IP Dome, Mini Fixed Dome, Mini Fixed Rugged Dome** and **Fixed IP Dome**. To adjust focus of a PTZ camera, refer to *11.6 Focus Adjustment*; for Cube Camera and Advanced Cube Camera, refer to Camera Adjustment in *19.2.2 The Control Panel on the Live View Window*.

After you have connected your GV-IPCAM H.264 to the network, follow the steps below to adjust image clarity.

1. Make sure you have installed the GV-IP Device Utility program included on the GV-IPCAM H.264 Software CD.

---

**Note:** The PC installed with GV-IP Device Utility must be under the same LAN with the GV-IPCAM H.264 you wish to configure.

---

- On the GV-IP Utility window, click the  button to search for the IP devices connected in the same LAN. Click the IP Address of the camera you desire. A drop-down list appears.

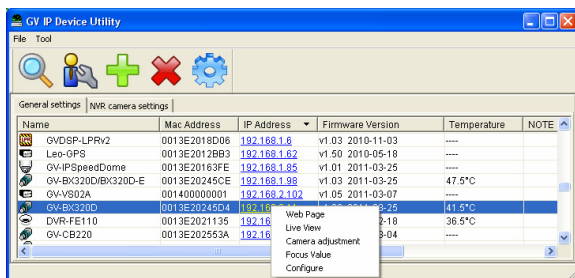

Figure 18-7

- Select Focus Value. The Login dialog box appears.

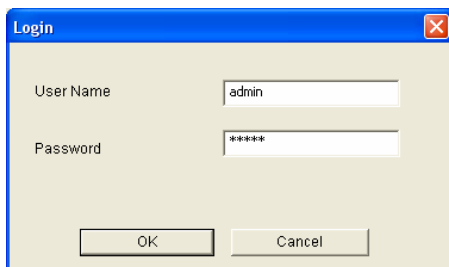

Figure 18-8

4. Type the user name and password of the camera selected. The default is **admin** for both user name and password. This window appears.

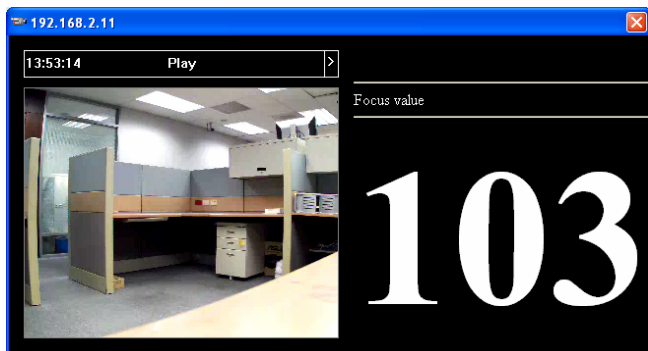

Figure 18-9

5. For **GV-VD120D / 121D / 220D / 221D / 320D / 321D / 1500 / 2400 / 2500 / 3400**, hold the supplied Focus Adjustment Cap over the camera view. For details, see *18.2.1 Using Focus Adjustment Cap* for details.
6. Adjust the Focus Screw and the Zoom Screw of the camera slowly until the focus value reaches the maximum. For example, the maximum focus value in Step 4 is 103. For locations of adjustment screws in each model, see *18.2.2 Locations of Adjustment Screws*.

---

**Note:**

1. Do not over tighten the screws. The screws only need to be as tight as your fingers can get them to be. Do not bother using any tool to get them tighter. Doing so can damage the structure of lens.
  2. The maximum focus value may vary when the environment changes.
-

## 18.2.1 Using Focus Adjustment Cap

The Focus Adjustment Cap is only supplied for IK10+ models (**GV-VD120D / 121D / 220D / 221D / 320D / 321D / 1500 / 2400 / 2500 / 3400**).





Hold the Focus Adjustment Cap on top of the camera view and keep it close to the camera.



Do not leave a distance between the Focus Adjustment Cap and the camera.

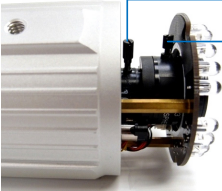
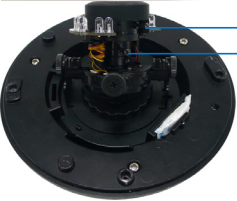

## 18.2.2 Locations of Adjustment Screws

Models	Adjustment Screws
Box Camera	 <p>Zoom Screw Focus Screw</p>
Bullet Camera	 <p>Zoom Screw Focus Screw</p>
Vandal Proof IP Dome	 <p>Focus Screw Zoom Screw</p>
Fixed IP Dome	 <p>Focus Screw Zoom Screw</p>

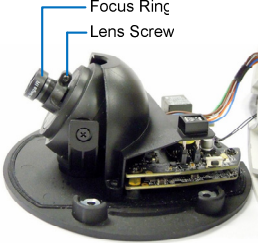
Models	Adjustment Screws
Mini Fixed Dome	 <p>A top-down view of a Mini Fixed Dome camera lens assembly. Two blue lines with labels point to the 'Lens Screw' and the 'Focus Ring'.</p>
Mini Fixed Rugged Dome	 <p>A side view of a Mini Fixed Rugged Dome camera lens assembly. Two blue lines with labels point to the 'Focus Ring' and the 'Lens Screw'.</p>

**Note:**

1. The adjustment screws of Box Camera may vary for different models.
2. To focus GV-MFD and GV-MDR, loosen the lens screw first and slowly adjust the focus ring. Some models may need a T6 screw driver to loosen the camera lens. If you have a problem of obtaining this type of screw driver, please contact our overseas offices for further assistance.

## 18.3 Configuring the Basics

Once the camera is properly installed, the following important features can be configured using the browser-based configuration page and are discussed in the following sections in this manual:

- **Date and time adjustment:** see *20.8.1 Date & Time Settings*.
- **Login and privileged passwords:** see *20.8.3 User Account*.
- **Network gateway:** see *20.7 Network*.
- **Camera image adjustment:** see *19.2.2 The Control Panel of the Live View Window*.
- **Video format, resolution and frame rate:** see *20.1.1 Video Settings*.

## Chapter 19 Accessing the Camera

Two types of users are allowed to log on to the GV-IPCAM H.264:

**Administrator** and **Guest**. The Administrator has full access to all system configurations, while the Guest can only access the live view (except the Camera Adjustment settings) and network status.

## 19.1 Accessing Your Surveillance Images

Once installed, your GV-IPCAM H.264 is accessible on a network. Follow these steps to access your surveillance images:

1. Start your web browser.
2. Enter the IP address or the domain name of the camera in the **Location/Address** field of your browser.

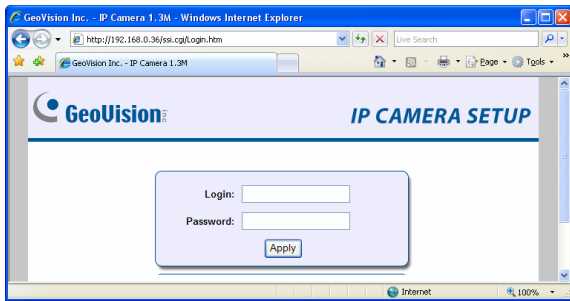

*Figure 19-1*

3. Enter the login name and password.
  - The default login name and password for Administrator are **admin**.
  - The default login name and password for Guest are **guest**.
4. Click **Apply**. A video image, similar to the example on Figure 19-2, is now displayed in your browser.

---

**Note:** To enable the updating of images in Internet Explorer, you must set your browser to allow ActiveX Controls and perform a once-only installation of GeoVision's ActiveX component onto your computer.

---

## 19.2 Functions Featured on the Main Page

This section introduces the features of the **Live View** window and **Network Status** on the main page. The two features are accessible by both Administrator and Guest.

### Main Page of Guest Mode

- ▼ Video and Motion
  - ▶ Live View
    - ▶ Camera
- ▼ Network
  - ▶ Status



Figure 19-2

The GV-IPCAM H.264 can process one video stream in two different codec and image settings. In the Administrator mode, both streams are available. Click **Streaming 1** or **Streaming 2** in the left menu to access the live view. In the Guest mode, only one stream is available, as shown in *Figure 19-2*.

## 19.2.1 The Live View Window

### Internet Explorer

When accessing the live view using Internet Explorer, the following window appears.



Figure 19-3A



Figure 19-3B

No.	Name	Function
1	Play	Plays live video.
2	Stop	Stops playing video.
3	Microphone	Broadcasts to the surveillance site from a remote PC. Note this function is not available for <b>Ultra Bullet Camera</b> and <b>Target Series</b> .



No.	Name	Function
4	Speaker	Transfers sounds of the surveillance site to a remote PC. Note this function is not available for <b>GV-MFD120D / 130D / 220D / 320D / 520D, Mini Fixed Rugged Dome, Ultra Bullet Camera, and Target Bullet Camera.</b>
5	Snapshot	Takes a snapshot of live video. --- See <i>19.2.3 Snapshot of Live Video.</i>
6	File Save	Records live video to the local computer. --- See <i>19.2.4 Video Recording.</i>
7	Full Screen	Switches to full screen view. Right-click the image to have these options: Snapshot, Full Screen, Resolution, Zoom In, Zoom Out, PIP and PAP. --- See <i>19.2.5 Picture-in-Picture and Picture-and-Picture View for PIP and PAP views</i>
8	Show System Menu	Brings up these functions: Alarm Notify, Video and Audio Configuration, Remote Config, Show Camera Name and Image Enhance. --- See <i>19.2.6 Alarm Notification, 19.2.7 Video and Audio Configuration, 19.2.8 Remote Configuration, 19.2.9 Camera Name Display, and 19.2.11. Image Enhancement.</i>
9	PTZ Control Panel	Enables the PTZ Control Panel or the Visual PTZ. --- See <i>8.8.1 The PTZ Control Panel and 19.2.11 Visual PTZ</i>  Note this function is only available in <b>PTZ Camera and PT Camera.</b>

No.	Name	Function
10	I/O Control	<p>Enables the I/O Control Panel or the Visual Automation.</p> <p>--- See 19.2.13 <i>I/O Control</i>.</p> <p>Note this function is only supported by cameras with I/O function.</p>
11	LED Control	<p>Click to turn the Alarm LED on and/or adjust the brightness sensitivity.</p> <p>Note this function is only available for <b>Advanced Cube Camera</b>.</p>
12	Alarm Speaker	<p>Click to sound the alarm and/or adjust its volume. To sound the alarm upon motion or tampering events, see 20.3.9 <i>Speaker</i> for setup steps.</p> <p>Note this function is only available for <b>Advanced Cube Camera</b>.</p>

## Non-IE Browsers

When accessing the live view using Google Chrome, Firefox or Safari, this window appears. Note the following functions are not supported on non-IE browsers: Motion Detection, Tampering Alarm, Visual Automation, Text Overlay, Two-Way Audio and GPS Settings.

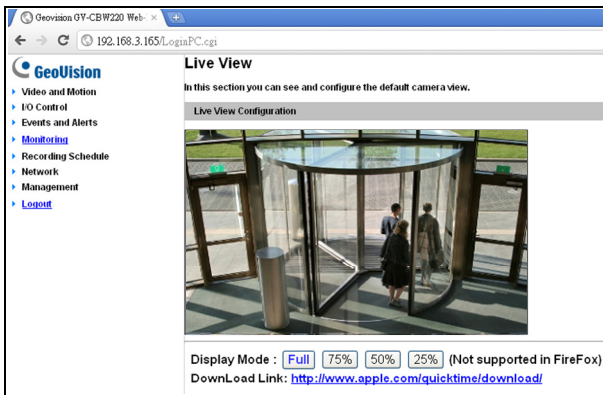

Figure 19-4

## 19.2.2 The Control Panel of the Live View Window

To open the control panel of the Live View window, click the arrow button on top of the window. You can access the following functions by using the right and left arrow buttons on the control panel.

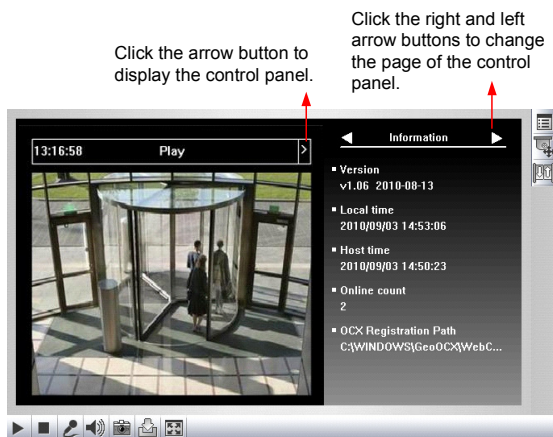
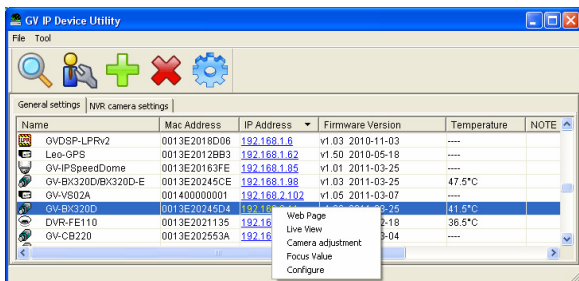

Figure 19-5

**Tip:** Administrator may also access live view and camera adjustment settings using the GV-IP Device Utility:



**[Information]** Displays the version of the camera, time of the local computer, time of the camera (host time), the number of users logging in the camera and the OCX registration path.

**[Video]** Displays the current video codec, resolution and data rate.



**[Audio]** Displays the audio data rates when the microphone and speaker devices are enabled.









**[I/O Control]** Note this function is only supported by cameras with I/O function. Provides a real-time graphic display of the input and output status. You can force the output to be triggered by double-clicking its icon.

**[Alarm Notify]** Displays the captured images by sensor triggers and motion detection. For this function to work, you have to configure the Alarm Notification settings first. See *19.2.6 Alarm Notification*.

**[Camera Adjustment]** Allows you to adjust the image quality settings. Click **Save** to store the changes to the settings. Note that this function is only accessible for Administrator.

- **Brightness:** Adjusts the brightness of the image.
- **Contrast:** Adjusts the relative differences between one pixel and the next.
- **Saturation:** Adjusts the saturation of the image.
- **Sharpness:** Adjusts the sharpness of the image
- **Gamma:** Adjusts the relative proportions of bright and dark areas
- **White balance:** The camera automatically adjusts the color to be closest to the image you are viewing. You can choose one of the four presets: **Auto**, **Outdoor**, **Indoor**, and **Fluorescent**. You can also choose **Manual** to adjust the white balance manually.
- **Flicker less:** The camera automatically matches the frequency of your camera's image to the frequency of indoor light sources, e.g. fluorescent lighting. You can also select 50 Hz or 60 Hz manually. If these don't match, faint light and dark bars may appear in your images. Check the power utility to determine which frequency is used.

- **Image Orientation:** Changes the image orientation on the Live View window.
- **Slowest Shutter Speed:** Shutter speed controls the amount of the lights enters the image sensor and directly impacts the quality of image presentation. A slow shutter speed allows higher light exposure that creates a brighter overall image by blurring moving objects and bringing out background details, and a faster shutter speed lowers color and image clarity in order to capture motions.
- The minimum shutter speed ranges from 1/5 to 1/8000 sec. In low light conditions, a fast shutter speed will lower color quality and image clarity. In this case, select the **Auto** option for automatic shutter control or select **Auto (High Speed Mode)** for a faster automatic shutter control.  
**D/N:** Select **Auto** for automatic switch between day mode and night mode depending on the amount of light detected. Select **Black and white** to switch the camera to night mode. Select **Color** to switch the camera to day mode. Sets the light sensor's sensitivity of switching between day mode and night mode. The value 10 is the most light-sensitive. For details, see *D/N, Special View Settings, 20.1.1 Video Settings*.
- **Wide Dynamic Range:** adjusts and generates clear live view when the scene contains very bright and very dark areas at the same time. Select **Auto (Strong)** to bring out details in the darks areas of the scene, select **Auto (Weak)** to bring out less detail in the dark area and at the same time keep the bright areas from overexposure, or select **Auto (Normal)** for a balanced effect. Select **Close** to disable the function.
- **Defog:** Select **Auto** to automatically enhance the visibility of images. Select **Close** to disable the function.
- **Super Low Lux:** Select **Auto** for the camera to automatically enhance the live view under insufficient light. Select **Close** to disable the function. The default setting is **Auto**.
- **Zoom:** Click the **Zoom In**  and **Zoom Out**  buttons to adjust the apparent distance of the scene.

- **Focus Change:** Click the **Focus In**  and **Focus Out**  buttons to adjust the focus. To focus automatically, click the **Auto Focus**  button.
- **Focus Mode:** Select **Normal Scan**, **Regional Scan** or **Full Scan** and then click the **Start**  button to automatically adjust the camera focus. The **Normal Scan** mode focuses the camera the fastest. The **Regional Scan** mode focuses the area selected on the live view. The **Full Scan** mode performs a detailed checkup and applies the best focus.
- **Day Night Focus:** Saves focus settings for day mode and night mode. Select **Auto** to automatically focus. To configure fixed settings for day mode and night mode, select **Manual** and follow the steps below:
  1. Make sure the **D/N** is in **Auto** mode for the best effect. The following focus setting will be applied to the current D/N mode.
  2. Adjust the focus using the **Focus In**  and **Focus Out**  buttons and/or the **Focus Mode** function.
  3. Click **Day Mode Save**  or the **Night Mode Save**  button depending on the current D/N mode.

**[Download]** Allows you to install the programs from the hard drive.

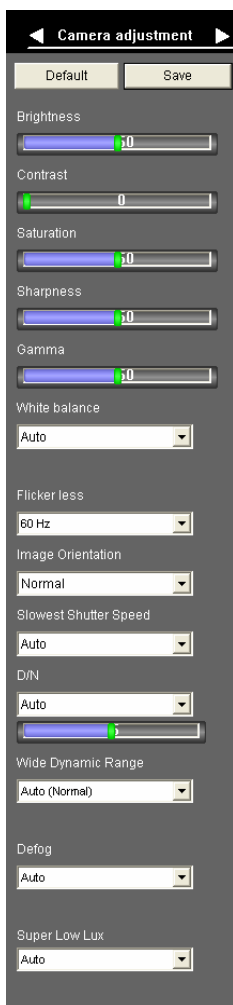

Figure 19-6A

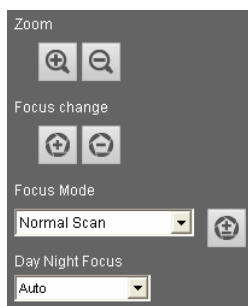

Figure 19-6B

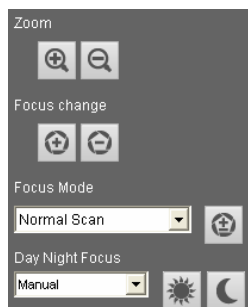

Figure 19-6C



---

**Note:**

1. GV-PTZ010D only contains the **Gamma** feature.
  2. **Saturation** is not available for GV-PTZ010D.
  3. **Slowest Shutter Speed** and **Defog** is not available for GV-BX140DW.
  4. **D/N**, **Slowest Shutter Speed** and **Defog** are not available for GV-PTZ010D.
  5. **D/N sensitivity adjustment** is not available for GV-BX140DW which automatically detects light with its built-in light sensor.
  6. **Wide Dynamic Range** is not available for GV-BX140DW and GV-PTZ010D.
  7. The **Zoom**, **Focus Change**, **Focus Mode** and **Day Night Focus** settings are only available for models with motorized varifocal lens.
  8. The **Super Low Lux** setting is only available for models with a super low lux CMOS sensor.
-

### 19.2.3 Snapshot of Live Video

To take a snapshot of live video, follow these steps:

1. Click the **Snapshot** button (No. 5, Figure 19-3). The Save As dialog box appears.
2. Specify **Save in**, type the **File name**, and select **JPEG** or **BMP** as **Save as Type**. You may also choose whether to display the name and date stamps on the image.
3. Click the **Save** button to save the image in the local computer.

### 19.2.4 Video Recording

You can record live video for a certain period of time to your local computer.

1. Click the **File Save** button (No. 6, Figure 19-3). The Save As dialog box appears.
2. Specify **Save in**, type the **File name**, and move the **Time Period** slider to specify the time length of the video clip from 1 to 5 minutes.
3. Click the **Save** button to start recording.
4. To stop recording, click the **Stop** button (No. 2, Figure 19-3).

## 19.2.5 Picture-in-Picture and Picture-and-Picture View

The full screen mode provides two types of close-up views: **Picture-in-Picture (PIP)** and **Picture-and Picture (PAP)**. The two views are useful to provide clear and detailed images of the surveillance area.

### Picture-in-Picture View

With the Picture in Picture (PIP) view, you can crop the video to get a close-up view or zoom in on the video.



*Figure 19-7*

1. Right-click the live view and select **PIP**. An inset window appears.
2. Click the insert window. A navigation box appears.
3. Move the navigation box around in the inset window to have a close-up view of the selected area.
4. To adjust the navigation box size, move the cursor to any of the box corners, and enlarge or diminish the box.
5. To exit the PIP view, right-click the image and click **PIP** again.

## Picture-and-Picture View

With the Picture and Picture (PAP) view, you can create a split video effect with multiple close-up views on the image. A total of 7 close-up views can be defined.



Figure 19-8

1. Right-click the live view and select **PAP**. A row of three inset windows appears at the bottom.
2. Draw a navigation box on the image, and this selected area is immediately reflected in one inset window. Up to seven navigation boxes can be drawn on the image.
3. To adjust a navigation box size, move the cursor to any of the box corners, and enlarge or diminish the box.
4. To move a navigation box to another area on the image, drag it to that area.
5. To add more navigation boxes, to show or hide navigation boxes or to change the frame color of the navigation boxes, right-click the image, select **Mega Pixel Setting** and click one of these options:
  - **Enable Add-Focus-Area Mode:** Allows the user to add more navigation boxes on the image. This option is not available when 7 navigation boxes have been drawn.
  - **Display Focus Area of PAP Mode:** Displays or hides the navigation boxes on the image
  - **Set Color of Focus Area:** Changes the color of the box frames.

6. To delete a navigation box, right-click the desired box, select **Focus Area of PAP Mode** and click **Delete**.
7. To exit the PAP view, right-click the image and click **PAP** again.

## 19.2.6 Alarm Notification

After input triggers and motion detection, you can be alerted by a pop-up live video and view up to four captured images.



Figure 19-9

To configure this function, click the **Show System Menu** button (No. 8, Figure 19-3), and select **Alarm Notify**. This dialog box appears.

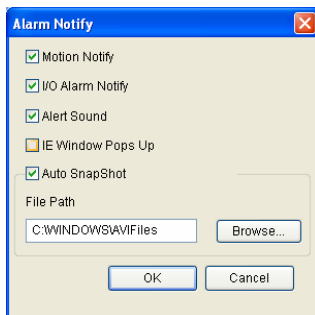

Figure 19-10

- Motion Notify:** Once motion is detected, the captured images are displayed on the control panel of the Live View window.

- **I/O Alarm Notify:** Once the input device is triggered, the captured images are displayed on the control panel of the Live View window. For this function to work, the Administrator needs to install the input device properly. See *20.2.1 Input Setting*.
- **Alert Sound:** Activates the computer alarm on motion and input-triggered detection.
- **IE Window Pops up:** The minimized Live View window pops up on motion and input-triggered detection.
- **Auto Snapshot:** The snapshot of live video is taken every 5 seconds on motion and input-triggered detection.
- **File Path:** Assigns a file path to save the snapshots.

## 19.2.7 Video and Audio Configuration

You can enable the microphone and speaker for two-way audio communication and adjust the audio volume. To change audio configuration, click the **Show System Menu** button (No. 8, Figure 19-3), and select **Video and Audio Configuration**.

- **Camera:** Sets the number of frames to keep in live view buffer. Keeping more frames for live view buffer can ensure a smooth live view, but the live view will be delayed for the number of frames specified.

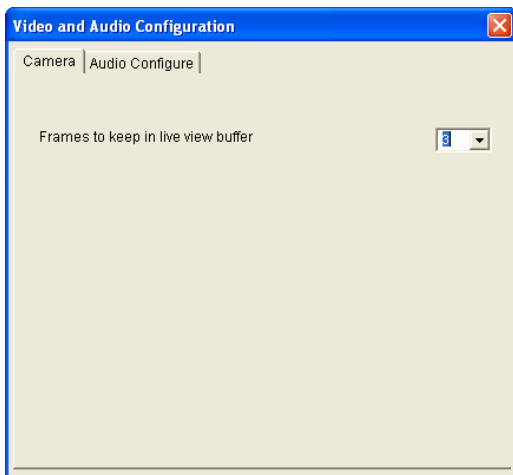

Figure 19-11



- **Audio Configure:** You can enable the microphone and speaker, and adjust the audio volume

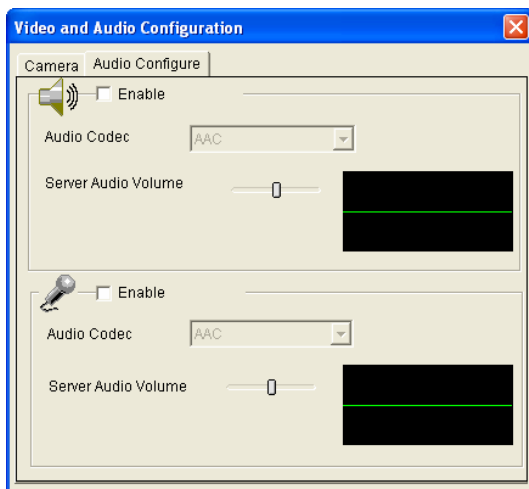

Figure 19-12

## 19.2.8 Remote Configuration

You can upgrade firmware over the network. Click the **Show System Menu** button (No. 8, Figure 19-3), and select **Remote Config**. The Remote Config dialog box will appear.

**[Firmware Upgrade]** In this tab, you can upgrade the firmware over the Internet. For details, see *Advanced Applications, Chapter 22*.

## 19.2.9 Camera Name Display

To display the streaming name on the image, click the **Show System Menu** button (No. 8, Figure 19-3), and select **Show Camera Name**.

## 19.2.10 Image Enhancement

To enhance the image quality of live video, click the **Show System Menu** button (No. 8, Figure 19-3), and select **Image Enhance**. This dialog box appears.

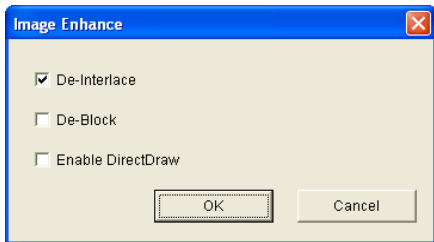

Figure 19-13

- **De-Interlace:** Converts the interlaced video into non-interlaced video.
- **De-Block:** Removes the block-like artifacts from low-quality and highly compressed video.
- **Enable DirectDraw:** Activates the DirectDraw function.

## 19.2.11 Visual PTZ

Note this feature is only available in **PTZ Camera** and **PT Camera**.

The Visual PTZ provides two types of PTZ control panels on live images for easy and direct PTZ operation.

### Activating Visual PTZ

Click the **PTZ Control** button  (No. 9, Figure 19-3) and select **Visual PTZ**. Alternatively right-click anywhere on the live view and select **Visual PTZ**.

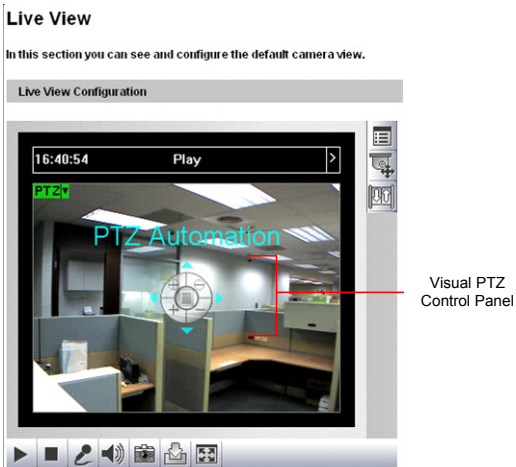

Figure 19-14



Figure 19-15

The Visual PTZ Panel provides the following features:

No.	Name	Description
1	Zoom In	Shortens the apparent distance between the camera and the view.
2	Zoom Out	Lengthens the apparent distance between the camera and the view.
3	Focus In	Adjusts the sharpness of the camera view.
4	Focus Out	
5	Home	Brings the camera to the home point.
6	Auto Focus	Automatically adjusts the sharpness of the camera view.
7	Preset Go	Starts a single movement in which the PTZ Camera moves towards a point in live view.
8	Go Sequence	Starts a series of movements in which the PTZ Camera moves towards at least two Preset points in live view.
9	Auto Pan	Starts a horizontal movement of the PTZ Camera in live view.

## Setting Visual PTZ Panel

Click the **PTZ** button on the top left corner and select Visual PTZ, the following options will appear.

- **PTZ Control Type:** Two types of visual PTZ control panels are available.
  - ⊙ **Type 1:** Appears only when a movement of the cursor is detected and disappears when it is static. When you place the cursor in one of the eight directions, i.e. up, down, left, right, left up, left down, right up and right down, a 5-level arrow appears. Click and hold onto the required level to move the camera. The speed level is indicated at the top right corner of the live view.
  - ⊙ **Type 2:** Appears with a click on the live view and disappears with the second click. As the cursor points to one of the eight directions, a 5-level arrow head appears. The further the arrow is away from the visual PTZ control panel, the faster the movement and vice versa. The speed level is indicated at the top right corner of the live view.
- **Set Color:** Changes the color of the arrow line and the speed indicated at the top right corner of the live view. Alternatively, you can right-click the live view (with Visual PTZ enabled). Three colors are available: **Red**, **Green** and **Blue**.
- **Transparency:** Changes the transparency level of the Visual PTZ Control Panel. Ten levels range from 10% (fully transparent) to 100% (fully opaque).

## 19.2.12 Digital PTZ

Note this function is only supported by **firmware V2.06**.

This function allows non-PTZ cameras to simulate PTZ movements on live view.

1. Right-click the live view and select **Digital PTZ**. The live view is labeled with “DPTZ” at the top left corner.



Figure 19-16

2. To zoom in / out, move the cursor to the live view and click the corresponding buttons. To bring the view back to its default image, click **Home**.

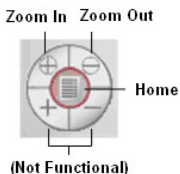
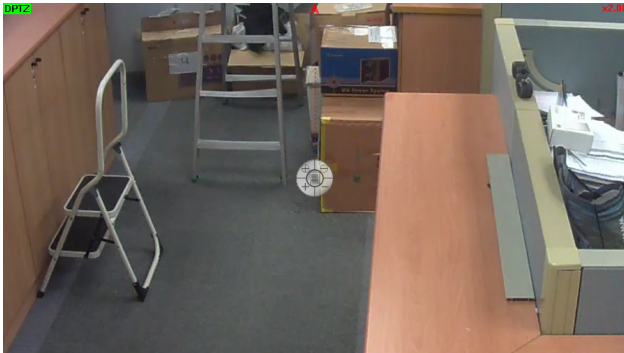

Figure 19-17

3. To pan and tilt the view, zoom the image first and then click and hold the arrow on the image. The arrow appears when you place the cursor in one of the eight directions, i.e. up, down, left, right, left up, left down, right up and right down.



*Figure 19-18*

4. To adjust the transparency level of the control panel, click the green **DPTZ** button and select **Transparency**. Ten levels range from 10% (fully transparent) to 100% (fully opaque) are available.

---

**Note:** The Focus In / Out and the speed level are not functional for Digital PTZ.

---

### 19.2.13 I/O Control

Note this function is only supported by cameras with I/O function.

The I/O Control window provides a real-time graphic display of camera status, I/O status, and alarm events. Additionally, you can remotely force output to be triggered.

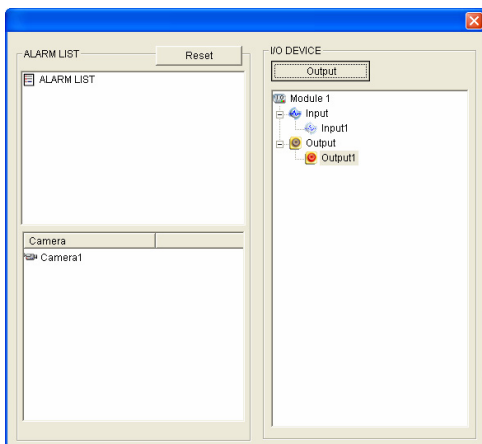

Figure 19-19

- To display the I/O control window, click the **I/O Control** button (No. 10, Figure 19-3) and select **I/O Control**.
- The Alarm List is displayed in three levels. The first level indicates date, the second indicates time, and the third indicates alarm ID. Clicking the **Reset** button will clear the list.
- To trigger an output device, highlight an output and then click the **Output** button.



## 19.2.14 Visual Automation

Note this function is only supported by cameras with I/O function.

The Visual Automation allows you to change the current state of the electronic device by simply clicking on its image, e.g. turning the light ON. This feature is only available when the Visual Automation is set ahead by the Administrator. For details, see 20.1.6 *Visual Automation*.

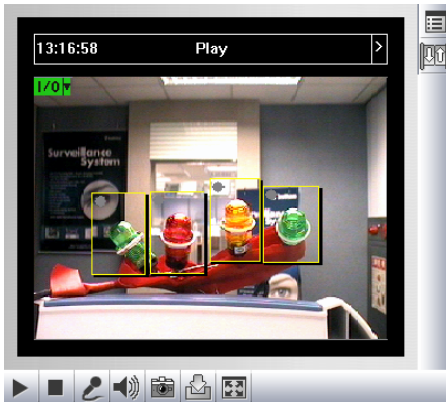

Figure 19-20

- To access this feature, click the **I/O Control** button (No. 10, Figure 19-3) and select **Visual Automation**.
- To change the style of the set areas, click the green **I/O** button on the top left corner. You will have these options:
  - **Show All:** Displays all set areas.
  - **Rect Float:** Embosses all set areas.
  - **Set Color:** Changes the frame color of all set areas

## 19.2.15 Network Status

To view the network status, in the left menu, click **Network** and select **Status**.

Network Status Information	
In this section you can see an overview of GV-IPCAM status.	
Current Status Information	
interface:	Wired
IP Acquirement:	Fixed
MAC Address:	0013E201DA81
IP Address:	192.168.2.11
Subnet Mask:	255.255.252.0
Gateway:	192.168.0.1
Domain Name Server 1:	168.95.192.1
Domain Name Server 2:	

Figure 19-21

## Chapter 20 Administrator Mode

The Administrator can access the system configuration through the network. Eight categories of configurations are involved in the system configuration: **Video and Motion**, **I/O Control** or **Digital I/O** and **PTZ**, **Events and Alerts**, **Monitoring**, **Recording Schedule**, **Remote ViewLog**, **Network** and **Management**.

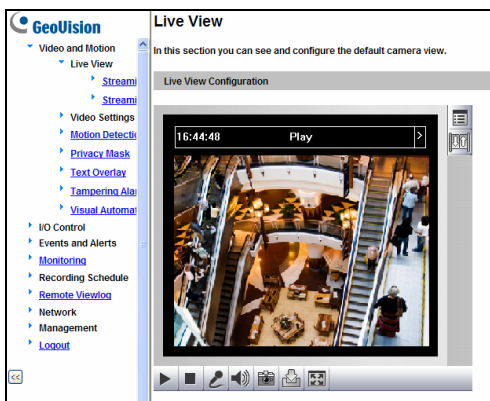

Figure 20-1

## List of Menu Options

Find the topic of interest by referring to the section number prefixed to each option. The available options vary among camera models.

20.1 Video and Motion	<ul style="list-style-type: none"> <li>20.1.1 Video Settings</li> <li>20.1.1 Motion Detection</li> <li>20.1.3 Privacy Mask</li> <li>20.1.4 Text Overlay</li> <li>20.1.5 Tampering Alarm</li> <li>20.1.6 Visual Automation</li> </ul>
20.2 Digital I/O and PTZ	<ul style="list-style-type: none"> <li>20.2.1 Input Settings</li> <li>20.2.2 Output Settings</li> <li>20.2.3 PTZ Settings</li> </ul>
20.3 Events and Alerts	<ul style="list-style-type: none"> <li>20.3.1 Email</li> <li>20.3.2 FTP</li> <li>20.3.3 Center V2</li> <li>20.3.4 VSM</li> <li>20.3.5 Backup Center</li> <li>20.3.6 Video Gateway/Recording Server</li> <li>20.3.7 ViewLog Server</li> <li>20.3.8 RTSP</li> <li>20.3.9 Speaker</li> </ul>
20.4 Monitoring	
20.5 Recording Schedule	<ul style="list-style-type: none"> <li>20.5.1 Camera</li> <li>20.5.2 I/O Monitor</li> </ul>
20.6 Remote ViewLog	
20.7 Network	<ul style="list-style-type: none"> <li>20.7.1 LAN</li> <li>20.7.2 Wireless-Client Mode</li> <li>20.7.3 Advanced TCP/IP</li> <li>20.7.4 IP Filtering</li> <li>20.7.5 SNMP Settings</li> </ul>

20.8 Management	20.8.1 Date and Time Settings 20.8.2 Storage Settings 20.8.3 User Account 20.8.4 Log Information 20.8.5 System Log 20.8.6 Tools 20.8.7 Language
-----------------	---

## 20.1 Video and Motion

The GV-IPCAM H.264 can simultaneously process one video source in two different codec and resolutions. The dual-stream design benefits for lower bandwidth environment, allowing Streaming 2 to be set with lower resolution and codec for live streaming, and Streaming 1 set with highest resolution and codec H.264 for best recording quality. Two setting pages **Streaming 1** and **Streaming 2** are provided for separate setup.

### Comparison between Streaming 1 and Streaming 2:

Video Setting Options	Streaming 1	Streaming 2
Watermark Setting	Yes	Not open for configuration. But settings in Streaming 1 are automatically applied to Streaming 2
Audio in Source		
Special View Setting		
Video Resolution	Yes. Different resolutions can be applied to Streaming 1 and Streaming 2.	
Audio Settings	Yes	No
TV Out	Yes	No
<b>Note:</b> <ol style="list-style-type: none"> <li><b>Audio In Source</b> is only available in GV-PTZ010D.</li> <li><b>Audio Settings</b> is not available for GV-PTZ010D.</li> <li><b>TV Out</b> is only available for Box Camera, IR Arctic Box Camera, Vandal Proof IP Dome and Fixed IP Dome.</li> </ol>		

This section includes the video image settings and how the images can be managed through Motion Detection, Privacy Mask, Text Overlay, Tampering Alarm, and Visual Automation.

## 20.1.1 Video Settings

### Video Settings

In this section you can define compression art, broadcasting method and privacy mask.

**Camera**

Name

**Connection template**

**Video Signal Type**

In this section you can configure camera's video signal, also the resolution and frame per second to be transmitted through the network

Video Format

Resolution	Frame per second
<input type="text" value="1920*1080 (16:9)"/>	<input type="text" value="30"/>

**Bandwidth Management**

In this section you can configure the bit rate used by video stream. When VBR (Variable Bit Rate) is selected, consistent image quality is achieved at the cost of varying bit rate. To set a consistent bit rate at the cost of varying image quality, select CBR (Constant Bit Rate).

<input checked="" type="radio"/>	VBR	Quality <input type="text" value="Good"/>	Maximal Bit Rate <input type="text" value="8"/>	Mbit
<input type="radio"/>	CBR	Maximal Bit Rate <input type="text" value="8192 Kbps"/>		

**Region Of Interest**

In this section you can configure ROI of H.264.

Enable [ROI Setting](#)

**GOP Structure and Length**

In this section you can configure the composition of the video stream (GOP structure). Using I-Frame only will significantly increase the video quality as well as the bandwidth.

Group of Picture(GOP) Size  (seconds)

**Video Slice Mode**

In this section you can decide Video Slice Mode for H.264 codec, in multi-slice mode, where a single frame is cut into multiple slices and processed separately by different CPU cores.

Video Slice Mode

Figure 20-2A

Record Settings	
<b>In this section you can configure pre-alarm and post-alarm settings.</b>	
Pre-alarm recording time	1 seconds
Post-alarm recording time	1 seconds with hard disk installed (1~30)
Split interval	5 minutes
<input type="checkbox"/> Record audio <input checked="" type="checkbox"/> Write recording data into local storage (If disabled, the camera will stop recording to local storage while live view is accessed through Web browsers or other applications.)	
Text Overlay Settings	
<b>In this section you can set up Text Overlay</b>	
<input type="checkbox"/> Overlaid with camera name <input type="checkbox"/> Overlaid with date stamps <input type="checkbox"/> Overlaid with time stamps <input type="checkbox"/> Overlay with digital input description name	
Watermark Setting	
<b>In this section you can set Watermark function.</b>	
<input type="checkbox"/> Enable	
TV-Out	
Signal Format <input type="radio"/> NTSC <input type="radio"/> PAL <input checked="" type="radio"/> Disable	
LED Control	
Ready LED <input checked="" type="radio"/> Enable <input type="radio"/> Disable	
Special View Setting	
<b>Additional functions for Live View</b>	
D/N <input checked="" type="radio"/> Auto    Sensitivity 5 <input type="radio"/> Black and White <input type="radio"/> Color	
IR Check Function: <input checked="" type="radio"/> Off <input type="radio"/> On <input type="radio"/> Trigger IR by D/N	
Auto Iris <input type="radio"/> Enable <input checked="" type="radio"/> Disable	
BLC <input checked="" type="radio"/> Off <input type="radio"/> On	
<input type="button" value="Apply"/>	

Figure 20-2B



**[Name]** Rename the video stream. To display the name of video stream on the Live View window, see *19.2.9 Camera Name Display*.

**[Connection Template]** Select the type of your network connection. Unless you select **Customized**, this option will automatically bring up the recommended video resolution, frame rate, bandwidth and GOP size.

**[Video Signal Type]** Select the video signal type, resolution and frame rate. Select between **H.264** and **MJPEG** as the codec type. For details on the resolutions and frame rates of each camera model, see *Appendix C*.

Note that for all the cameras (except GV-PTZ010D), the resolution options available for sub stream vary with the resolution selected for its main stream. For example, if a 4:3 resolution is selected for the main stream in GV-BX320D-0, two options, 640 x 480 and 320 x 240 will be available for its sub stream.

**[Bandwidth Management]** When using the H.264 codec, it is possible to control the bitrate, which in turn allows the amount of bandwidth usage to be controlled.

- **VBR (Variable Bitrate):** The quality of the video stream is kept as constant as possible at the cost of a varying bitrate. The bandwidth is much more efficiently used than a comparable CBR.

Set the image quality to one of the 5 standards: **Standard**, **Fair**, **Good**, **Great** and **Excellent**.

**Maximal Bit Rate:** When the actual bitrate exceeds the specified Maximal Bit Rate, the system will automatically lower its bitrate so as not to exceed it. Select one of the bitrates from the drop-down list or select **Auto** if you do not want to enable this function. The default maximal bitrate values are detailed as follows:

Camera Type		Default Max. Bitrate for VBR
1.3 MP	Stream 1	6 Mbit
	Stream 2	4 Mbit
2 MP	Stream 1	8 Mbit
	Stream 2	4 Mbit
3 MP	Stream 1	12 Mbit
	Stream 2	4 Mbit
4 MP	Stream 1	16 Mbit
5 MP	Stream 1	20 Mbit
	Stream 2	4 Mbit

- CBR (Constant Bitrate):** CBR is used to achieve a specific bitrate by varying the quality of the H.264 stream. Select one of the bitrates from the drop-down list.

**[Region of Interest]** Note this function is not supported for **Target Series**. Defines clarity and sets privacy mask to different parts of the live view for standalone GV-IP Cameras, GV-IP Cameras connecting to GV-System or third-party software through ONVIF/RTSP. This function is disabled by default.

---

**IMPORTANT:** If your GV-IP Camera is connected to GV-System or a third-party software that contains the privacy mask function, it is advised to use the privacy mask function on GV-System/third-party software to reduce the camera's loading.

---

Select **Enable** and click **ROI Setting** to configure:

1. On the popup window, use your mouse and draw directly on the live view to specify a region.

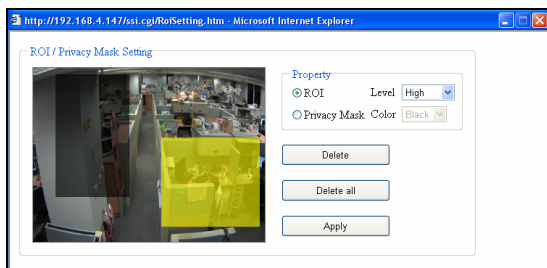

*Figure 20-3*

2. To define clarity to the region, select **ROI** and select **High**, **Medium** or **Low** using the drop-down list.
3. To set a Privacy Mask, select **Privacy Mask** and select a color using the drop-down list.
4. Click **Apply** to apply the configurations.

**[GOP Structure and Length]** Set the maximum number of seconds between every key frame.

**[Video Slice Mode]** Note this function is not supported for **Target Series**. Corrects the display mode of the camera when it is displayed on a third-party NVR/DVR software and the live view is incomplete or broken. Select **Single Slice** or **Multi Slice** to display the live view. The default is **Auto**.

**[Record Settings]** Note this function is not available for **IR Arctic Box Camera** and **Target Series**. The alarm settings allow you to capture images before and/or after the motion or I/O events happen.

- **Pre-alarm recording time:** Activates video recording before an event occurs. Set the recording time to 1 or 2 seconds. The recording is saved in the buffer of the camera.
- **Post-alarm recording time:** Activates video recording onto the inserted memory card after an event occurs. Set the recording time from 1 to 30 seconds.
- **Split-interval (Max. Video Clip):** Sets the maximum time length of each recorded file from 1 to 5 minutes.
- **Record audio:** Activates audio recording when an event occurs.
- **Write recording data into local storage:** Select this function for uninterrupted recording to the memory card while the live view is accessed through the Web interface or other applications. This option is enabled by default.

---

**IMPORTANT:** To ensure the quality of simultaneous recording and live view access, make sure you connect no more than two connections to the camera using Web interface or any other applications.

---

#### [Text Overlay Settings]

- **Overlaid with camera name:** Includes streaming names on live and recorded videos.
- **Overlaid with date stamps:** Includes date stamps on live and recorded videos.
- **Overlaid with time stamps:** Includes time stamps on live and recorded videos.
- **Overlaid with digital input description:** Note this function is only supported by cameras with I/O function. Includes the name of the selected input on live and recorded videos.

**[Watermark Setting]** Note this function is not supported for **Target Series**. Enable this option to watermark all recordings. The watermark allows you to verify whether the video has been tampered while it was recorded. See *22.4 Verifying Watermark*.

**[Audio In Source]** Note this function is only available in **GV-PTZ010D** which contain a built-in microphone and also allow you to install an external microphone.

- **Built-in Microphone:** Enable the built-in microphone to record sounds. By default the option is enabled.
- **External Microphone:** Enable the externally connected microphone to record sounds.

**[TV Out]** Note this function is only available for **Box Camera, IR Arctic Box Camera, Vandal Proof IP Dome and Fixed IP Dome**. Select the signal format of the Video Output on the camera as either NTSC or PAL.

---

**Note:** For smooth display of **Box Camera, IR Arctic Box Camera, Fixed IP Dome and Vandal Proof IP Dome** on TV monitor, the video resolution must be 1280 x 1024 or lower. If dual streams are enabled, the sub stream must be set as 640 x 480.

---

**[LED Control]** Note this function is not available in **GV-PTZ010D**.

- **Ready LED:** Select **Disable** if you do not wish to use the Status LED.
- **LAN LED, WAN LED, Monitoring LED:** Note this option is only available in **Advanced Cube Camera**. Select **Disable** if you do not wish to use the LEDs. For details on LED status, see *17.3 Overview*.
- **Alarm LED:** Sets the **white illumination LED** (No. 4, Figure 17-1) in **Advanced Cube Camera**. The LED is enabled by default.

- **Auto:** Select **Auto** for the white illumination LED to illuminate the scene automatically when the PIR sensor detects any motion within 5 meters.
- **Sensitivity:** Set the sensitivity for low light detection. The higher the value, the easier the white illumination LED is to be triggered. The default value is **5**.
- **The Interval between triggering:** Select the duration for the white illumination LED to light up at full intensity. If a motion persists over the specified period, the white illumination LED will light up with less intensity. This option is designed to keep the camera temperature within its precautionous range. The default value is **60** seconds.
- **Off:** Select to disable the white illumination LED.

#### [Special View Setting]

- **D/N:** Sets the sensitivity of day-night mode switch. The higher the sensitivity value, the more sensitive the switch is from day mode to night mode. The default value is **5**.
  - **Auto:** Select **Auto** for the camera to detect the amount of light present and automatically switch to monochrome in a poorly-lit scene. Move the slider to adjust the sensitivity level from 0 to 10.
  - **Black and White:** Select this option for the live view to be in monochrome.
  - **Color:** Select this option for the live view to be in color.
- **IR Check Function:** Note this option is only available for **Box Camera**. This function determines whether the surveillance area is illuminated by an externally installed infrared illuminator.
  - **Off:** The default setting. The infrared illuminator will be constantly off. It is advisable to enable this option when the color temperature of outdoor lighting is 6000 K or above.
  - **On:** The infrared illuminator will be constantly on.

- ⊙ **Trigger by Input / Trigger IR by D/N:** Select this option for the infrared illuminator to turn on under low light and turn off under sufficient light.

---

**Note:**

1. The **D/N** settings are not available for **GV-BX140DW**.
2. If an infrared illuminator is installed for outdoor surveillance, it is suggested to use the **Trigger by Input** or the **Trigger IR by D/N** function to avoid incorrect judgment of lighting and hence the action of the IR cut filter. See *2.5.2 Infrared Illuminators*.
3. If you select **Trigger by Input / Trigger IR by D/N** option, make sure you have set **D/N** as **Auto** and configured its sensitivity level.

- 
- **Auto Iris:** Note this function is not supported in cameras with fixed lens or fixed iris. The option is designed for auto iris lens (DC drive). Enable the auto iris function when the scene appears fuzzy and the Flicker Less function does not help to improve the situation.
  - **BLC:** Note this function is not supported by **GV-BX140DW**. Select **On** to enable Backlight Compensation (BLC). This function is used to adjust the color intensity of scenes with strong light at the background.

---

**Note:** To access the BLC function in PTZ camera, see *Other, 11.8.4 Image Settings*.

---

- **IR Light:** Note this function is only available for **Target Series, Ultra Box Camera, IR Arctic Box Camera, Bullet Camera, Ultra Bullet Camera, PT Camera, Vandal Proof IP Dome** and **Fixed IP Dome**. Select **Auto** for automatic switch between day mode and night mode depending on the amount of light detected. Select **Off** to completely disable IR LEDs.

## 20.1.2 Motion Detection

Note for firmware V1.07 or later and the Target Series (except GV-PTZ010D), motion detection is disabled by default; for GV-PTZ010D, motion detection is enabled by default.

Motion detection is used to generate an alarm whenever movement occurs in the video image. You can configure up to 8 areas with different sensitivity values for motion detection. Set up at least one area to enable this function.

### Motion Detection

In this section you can define different region(s) for motion detection.

To trigger digital output relay upon motions, be sure to set up the detection area on the Motion Detection page.

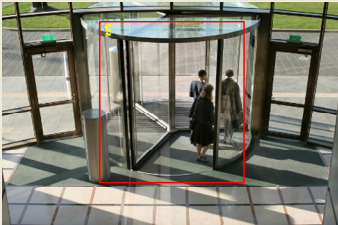

Camera 

  
Sensitivity: 9

---

#### Motion Detection

Use PIR to detect motion  
 Ignore environmental changes  
 Noise Tolerance

#### Advanced Setting

Please advise which action(s) should be taken when motion detection is activated.

Trigger digital output relay  Output 1

Figure 20-4



1. Select the desired sensitivity by moving the slider. There are ten values. The higher the value, the more sensitive the camera is to motion.
2. Drag an area on the image. Click **Add** when you are prompted to confirm the setting.
3. To create several areas with different sensitivity values, repeat steps 1 and 2.
4. Click **Save** to save the above settings.
5. Click **Reset** to delete all the selected areas.
6. If you want to detect motion using the PIR sensor (for **Advanced Cube Camera** only), select **Use PIR to detect motion**.
7. If you want to ignore environmental changes such as rain or snow, select **Ignore environmental changes**.
8. The **Noise Tolerance** function is enabled by default. It ignores video noise when the light intensity changes.
9. If you want to trigger the alarm output when motion is detected, select **Output 1** and click the **Apply** button. To activate the output settings, you must also start **Input** monitoring manually or by schedule. For related settings, see *20.4 Monitoring*.

### 20.1.3 Privacy Mask

The Privacy Mask function is used to block out sensitive areas on live view and recorded clips for cameras connecting to GeoVision software. This feature is ideal for locations with displays, keyboard sequences (e.g. passwords), and for anywhere else you don't want sensitive information visible.

---

**Note:** To set up a privacy mask on a GV-IP Camera connected to third-party software through ONVIF/RTSP, see *Region of Interest, 20.1.1 Video Settings*.

---

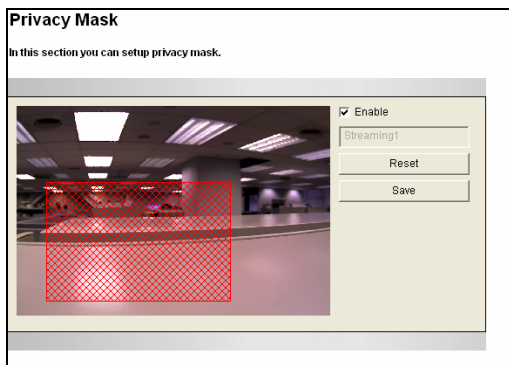

Figure 20-5

1. Select the **Enable** option.
2. Drag the area(s) where you want to block out on the image. Click **Add** when you are prompted to confirm the setting.
3. Click the **Save** button to save all the settings.

## 20.1.4 Text Overlay

The Text Overlay allows you to overlay any text in any place on the camera view. Up to 16 text messages can be created on one camera view. The overlaid text will be saved in the recordings.

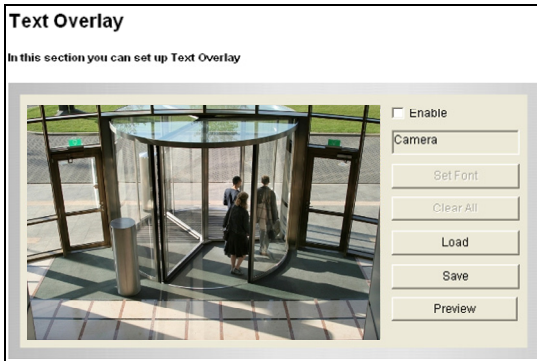

Figure 20-6

1. Select the font, font style and font size in a pop-up window.
2. Select the **Enable** option.
3. Click any place on the image. This dialog box appears.

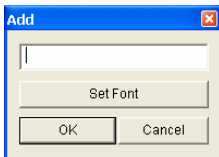

Figure 20-7

4. Type the desired text, and click **OK**. The text is overlaid on the image.
5. Drag the overlaid text to a desired place on the image.

6. Click **Set Font** to modify the font settings.
7. Click **Save** to apply the settings, or click **Load** (Undo) to revert to the last saved setting.
8. Click **Preview** to see how the text will appear on the image. Click **Close** to end the preview.

## 20.1.5 Tampering Alarm

Note this function is not available for **PTZ Camera** and **PT Camera**.

The Tampering Alarm is used to detect whether a camera is being physically tampered. An alarm can be generated when the camera is moved, covered up, or out of focus. The alarm approaches include the triggered output device and e-mail alert. To have the tampering alarm, first set up these alarm approaches properly:

- To trigger the output device when a tampering event occurs, enable the output setting and select **Tampering Alarm**. See *20.2.2 Output Settings*.
- To trigger the e-mail alert when a tampering event occurs, enable the e-mail setting and select **Tampering Alarm**. See *20.3.1 E-Mail*.

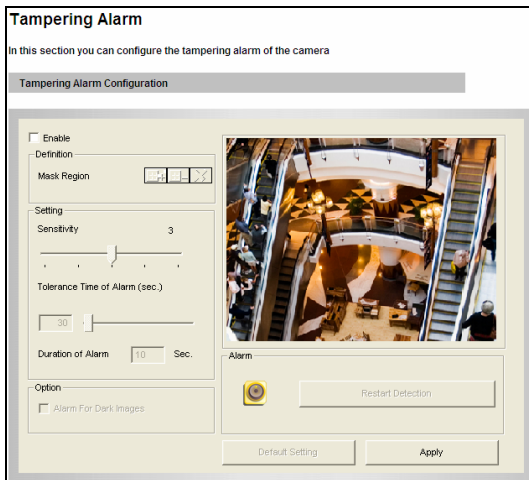



Figure 20-8

To configure the tampering alarm:

1. Select the **Enable** option.
2. If you want the camera to ignore any movement or scene change in certain areas, click the  button to drag areas on the camera view.
3. Select the desired detection sensitivity by moving the slider. The higher the value, the more sensitive the camera is to scene changes.
4. In the **Tolerance Time of Alarm** field, specify the time length allowed for scene changes before an alarm is generated.
5. In the **Duration of Alarm** field, specify the duration of the alarm after which the triggered output device will be turned off.
6. To trigger an alarm when the scene turns dark, e.g. the lens of camera has been covered, select **Alarm for Dark Images**.
7. Click **Apply** to save all the settings.
8. Start monitoring to enable the function. To have output alarm, it is required to start **Input** monitoring. See *20.4 Monitoring*.

When the camera has been tampered, the output device can be activated. To turn off the output device immediately, return to this setting page, and click **Restart Detection**.

## 20.1.6 Visual Automation

Note this function is only supported by cameras with I/O function.

This intuitive feature helps you automate any electronic device by triggering the connected output device. When you click on the image of the electronic device, you can simply change its current state, e.g. light ON.

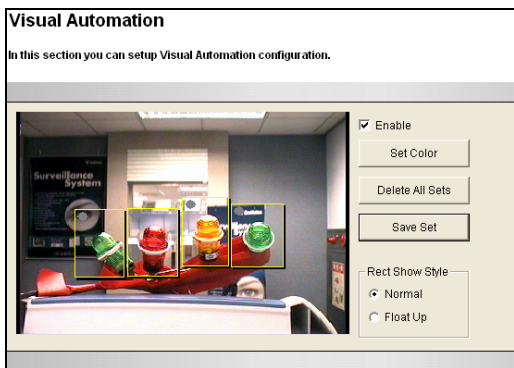

Figure 20-9

1. Select the **Enable** option.
2. Drag an area on the image of the electronic device. This dialog box appears.

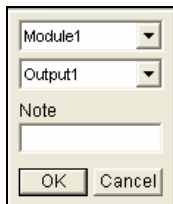

Figure 20-10

3. Assign the connected module and output device. In the Note field, type a note to help you manage the device. Click **OK** to save the settings.
4. To change the frame color of the set area, click the **Set Color** button.
5. To emboss the set area, select **Float Up**; or keep it flat by selecting **Normal**.
6. Click the **Save Set** button to apply the settings.
7. To perform the function, see *19.2.14 Visual Automation*.



## 20.2 I/O Settings

Note the I/O settings are only available for **Box Camera**, **Bullet Camera**, **Ultra Bullet Camera**, **PTZ Camera**, **PT Camera**, **Vandal Proof IP Dome** and **Fixed IP Dome**.

After installing the I/O device, you need to enable the I/O settings on the camera. For how to install the I/O device on the camera, see the following reference sections:

<b>GV-IPCAM H.264</b>	<b>Reference section</b>
Box Camera	<i>2.6 I/O Terminal Block</i>
Bullet Camera	<i>8.4.1 Connecting the Camera</i>
PTZ Camera	<i>11.7 I/O Terminal Block</i>
PT Camera	<i>12.7 I/O Terminal Block</i>
Vandal Proof IP Dome	<i>13.5 Connecting the Camera</i>
Fixed IP Dome	<i>15.6 I/O Terminal Block</i>

## 20.2.1 Input Settings

To activate the sensor input, select **Enable**.

### Input Setting

In this section you can configure GV-IPCAM digital input port.

**Digital Input 1**

Enable

Name

Normal State  Open Circuit (N/O)  Grounded Circuit (N/C)

Latch Mode  Enable

Trigger digital output relay  Output 1

Record  Camera

Send Video to CenterV2  Camera

PTZ Settings

Set PTZ camera to preset point

Input on  ▾

Input off  ▾

Duration to set preset after input off  seconds

Figure 20-11

- **Normal State:** You can set the input state to trigger actions by selecting **Open Circuit (N/O)** or **Grounded Circuit (N/C)**.
- **Latch Mode:** Enable this option to have a momentary output alarm.
- **Trigger digital output relay:** When this option is enabled, the output will be triggered once the input is activated.
- **Record:** Enable this option to start recording when the input is triggered.
- **Send Video to Center V2:** Enable this option to send the images to Center V2 when the input is triggered.

- **PTZ Settings:** Note this function is only available for **PTZ Camera** and **PT Camera**.
  - ⊙ **Input On:** Select a preset point to which the camera turns when an input is triggered.
  - ⊙ **Input Off:** Select a preset point to which the camera returns when the input triggering is off.
  - ⊙ **Duration to set preset after input off:** Specify the duration that the camera stays at the Input On point before returning to the Input Off point.

---

**Note:**

1. The GV-IP Cameras support dry-contact input device.
  2. The functions “triggering the output”, “starting the recording when the input is triggered” and “sending video to Center V2” only work after you start **Input** monitoring manually or by schedule. To configure the input monitoring, see *20.4 Monitoring*.
-

## 20.2.2 Output Settings

Select **Enable** to start the output device. Choose the output signal that mostly suits the device you are using: N/O (Open Circuit), N/C (Grounded Circuit), N/O Toggle, N/C Toggle, N/O Pulse or N/C Pulse. For **Toggle** output type, the output continues to be triggered until a new input trigger ends the output. For **Pulse** output type, the output is triggered for the amount of time you specify in the **Trigger Pulse Mode for x Seconds** field.

**[Alarm Settings]** You can choose to automatically trigger the digital output under these conditions: tampering alarm (not available for **PTZ Camera**), disk write error (Rec Error) and full memory card (HD Full).

### Output Setting

In this section you can configure GV IP-Camera digital output port.

**Digital Output 1 - Normal State**

Enable

Name

General Mode  Open Circuit (N/O)  Grounded Circuit (N/C)

Toggle Mode  Open Circuit (N/O)  Grounded Circuit (N/C)

Pulse Mode  Open Circuit (N/O)  Grounded Circuit (N/C)

Trigger Pulse Mode for  seconds(1~60)

**Digital Output 1 - Alarm Settings**

Tampering Alarm

Rec Error

HD Full

Figure 20-12

## 20.2.3 PTZ Settings

Note this function is only available in **PTZ Camera** and **PT Camera**.

You can change the image settings, configure sequences, and access settings including autopan speed, motor reset, digital zoom and system default loading. For details, see *Accessing the VISCA OSD Configuration* in *8.7.3 PTZ Camera Settings*.

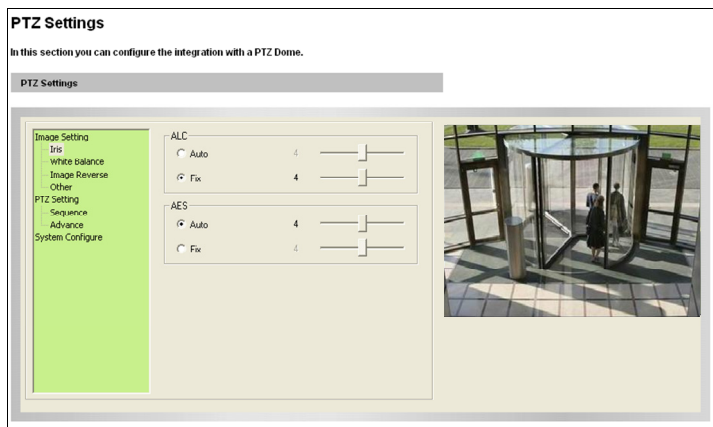

Figure 20-13

## 20.3 Events and Alerts

For the events of motion detection or I/O trigger, the Administrator can set up two trigger actions:

1. Send a captured still image by E-mail or FTP.
2. Notify Center Monitoring Station, Center V2 or VSM, by video or text alerts.

To have the above trigger actions, you must set the following functions in advance:

- Motion Detection (See *20.1.2 Motion Detection*)
- Input Setting (See *20.2.1 Input Setting*)
- For e-mail and FTP alerts, it is required to start monitoring (See *20.4 Monitoring*).

## 20.3.1 E-mail

After a trigger event, the camera can send the e-mail to a remote user containing a captured still image.

**Email**

In this section you can configure mailserver (SMTP) to handle events, videos, and error messages.

**Primary mail server**

Enable

Server URL/IP Address

Server Port

From email address

Send to  (Please use ";" to separate recipient's address)

Alerts Interval time in minute (0 to 60)

Need authentication to login

User Name

Password

This server requires a secure connection (SSL)

**Email - Alarm Settings**

Tampering Alarm

Rec Error

HD Full

Motion Detection

Digital Input

Figure 20-14

**[Enable]** Select to enable the e-mail function.

- **Sever URL/IP Address:** Type the URL address or IP address of the SMTP Server.
- **Server Port:** Modify the port number of the SMTP Server. Or keep the default value 25.
- **From email address:** Type the sender's e-mail address.
- **Send to:** Type the e-mail address(s) you want to send alerts to.

- **Alerts Interval Time:** Specify the interval between e-mail alerts. The interval is between 0 and 60 minutes. The option is useful for the frequent event occurrence, by which any event triggers during the interval period will be ignored.

**[Need authentication to login]** If the SMTP Server needs authentication, enable this option and type a valid username and password to log in the SMTP server.

**[E-Mail Alarm Settings]** You can choose to automatically send an e-mail alert under these conditions: tampering alarm, disk write error (Rec Error), full memory card (HD Full), motion detection and input trigger. Note that the alert condition is only supported if the corresponding function is supported in that camera model.

---

**IMPORTANT:** To send e-mail alerts upon motions, be sure to set up detection area on the Motion Detection's page.

---

For the related settings to send e-mail alerts, see *20.1.2 Motion Detection*, *20.2.1 Input Setting* and *20.4 Monitoring*.



## 20.3.2 FTP

You can also send the captured still image to a remote FTP server for alerts.

**FTP Client and Server Setting**

In this section you can configure a ftp server (File Transfer Protocol) to handle events, videos, and error messages.

**Upload to a FTP server**

Enable

Server URL/IP Address

Server Port

User Name

Password

Remote Directory

Alerts Interval time in minute (0 to 60)

**FTP - Alarm Settings**

Motion Detection

Continuously send images upon trigger events(Motion)

Digital Input

Continuously send images upon trigger events(Input)

**Act as FTP server**

In this section you can enable/disable GV-IPCAM internal ftp server for file transfer.

Enable ftp access to the GV-IPCAM

Use alternative Port

Figure 20-15

### [Upload to an FTP Server]

- **Enable:** Select to enable the FTP function.
- **Server URL/IP Address:** Type the URL address or IP address of the FTP Server.
- **Server Port:** Type the port number of the FTP Server. Or keep the default value 21.
- **User Name:** Type a valid username to log into the FTP Server.

- **Password:** Type a valid password to log into the FTP Server.
- **Remote Directory:** Type the name of the storage folder on the FTP Server.
- **Alerts Interval time in minute:** Specify the interval between FTP alerts. The interval can be between 0 and 60 minutes. The option is useful for the frequent event occurrence by which any event triggers during the interval period will be ignored.

### [Alarm Settings]

- **Motion Detection:** When a motion is detected on the camera, a still image will be sent to the FTP Server.
  - **Continuously send images upon trigger events (motion):** A sequence of snapshots is uploaded to the FTP Server when a motion is detected. This stops as soon as no motion is detected.
- **Digital Input:** Note this function is only supported by cameras with I/O function. Once the input is triggered, a still image will be sent to the FTP Server.
  - **Continuously send images upon trigger events (input):** A sequence of snapshots is uploaded to the FTP Server when the input is triggered.

---

**IMPORTANT:** To send FTP alerts upon motions, be sure to set up detection area on the [Motion Detection's](#) page.

---

**[Act as FTP Server]** Note this function is not available for **Target Series**.

- **Enable FTP access to the GV-IP Cam:** The camera acts as an FTP server, enabling users to download AVI files.
- **Use alternative port:** The default port is set to 21.

To access the internal FTP server through a web browser, enter the IP address or the domain name of the camera in your browser like this:

ftp://192.168.0.10

When you are prompted for Username and Password, enter the default value username **ftpuser** and password **123456**. Then you should find the AVI files recorded after trigger events.

To change login information of the internal FTP server, see *20.8.3 User Account*. For related settings to send FTP alerts, see *20.1.2 Motion Detection*, *20.2.1 Input Settings* and *20.4 Monitoring*.

### 20.3.3 Center V2

After a motion or an I/O triggered event, the central monitoring station Center V2 can be notified by live videos and text alerts. For the live monitoring through Center V2, you must already have a subscriber account on Center V2. A camera can connect to up to 2 Center V2 stations simultaneously.

---

**IMPORTANT:** To notify Center V2 server upon motions, be sure to set up detection areas on the Motion Detection's page,

---

Connection 1
Connection 2

## Center V2

In this section you can configure the connection to Center V2 and tasks to perform.

### Center V2 server

Activate Link

Host name or IP Address:

Port number:

User Name:

Password:

Cease motion detection messages from  Camera

Cease input trigger message from  Input 1

Enable schedule mode

### Select schedule time

Span 1     Next Day

Span 2     Next Day

Span 3     Next Day

Weekend  Saturday and Sunday  Only Sunday

### Connection Status

Status: Connected. Connected Time: Mon Sep 20 13:36:50 2010

Figure 20-16

To enable the Center V2 connection:

1. **Activate Link:** Enable the monitoring through Center V2.
2. **Host Name or IP Address:** Type the host name or IP address of Center V2.
3. **Port Number:** match the port to the Port 2 value on Center V2 or keep the default value **5551**.
4. **User Name:** type a valid username to log into Center V2.
5. **Password:** Type a valid password to log into Center V2
6. Click **Apply**. The Connection Status should display “Connected” and connected time.
7. To establish connection to the second Center V2 server, click the **Connection 2** tab and repeat the above steps for setup.

You can also find the following options on this Center V2 setting page:

- **Cease motion detection messages from:** Stops notifying Center V2 of motion-triggered events.
- **Cease input trigger messages from:** Note this function is only supported by cameras with I/O function. Stops notifying Center V2 of input-triggered events.
- **Enable schedule mode:** Starts the monitoring through Center V2 based on the schedule you set in the **Select Schedule Time** section. Refer to *20.5 Recording Schedule* for the same settings.

For related settings to activate the monitoring through Center V2, see *20.1.2 Motion Detection*, *20.2.1 Input Setting* and *24.1 Center V2*.

## 20.3.4 VSM

After a motion or an I/O triggered event, the central monitoring station VSM can get notified by text alerts. For the monitoring through VSM, you must already have a subscriber account on VSM. A camera can connect up to 2 VSM simultaneously.

---

**IMPORTANT:** To notify VSM server upon motions, be sure to set up detection areas on the Motion Detection's page,

---

Connection 1 | Connection 2

### Vital Sign Monitor Server Setting

In this section you can configure the connection to VSM Server and tasks to perform.

**Vital Sign Monitor Server**

Activate Link	<input checked="" type="checkbox"/>
Host name or IP Address:	<input style="width: 150px;" type="text" value="192.168.3.62"/>
Port number:	<input style="width: 50px;" type="text" value="5609"/>
User Name:	<input style="width: 150px;" type="text" value="1"/>
Password:	<input style="width: 150px;" type="password" value="•"/>
Cease motion detection messages from	<input type="checkbox"/> Camera
Cease input trigger message from	<input type="checkbox"/> Input 1
Enable schedule mode	<input type="checkbox"/>

**Select schedule time**

<input type="checkbox"/> Span 1	<input type="text" value="00"/>	<input type="text" value=":00"/>	<input type="text" value="~00"/>	<input type="text" value=":00"/>	<input checkbox"="" type="text" value="Next Day&lt;/td&gt; &lt;/tr&gt; &lt;tr&gt; &lt;td&gt;&lt;input type="/> Span 2	<input type="text" value="00"/>	<input type="text" value=":00"/>	<input type="text" value="~00"/>	<input type="text" value=":00"/>	<input checkbox"="" type="text" value="Next Day&lt;/td&gt; &lt;/tr&gt; &lt;tr&gt; &lt;td&gt;&lt;input type="/> Span 3	<input type="text" value="00"/>	<input type="text" value=":00"/>	<input type="text" value="~00"/>	<input type="text" value=":00"/>	<input checkbox"="" type="text" value="Next Day&lt;/td&gt; &lt;/tr&gt; &lt;tr&gt; &lt;td&gt;&lt;input type="/> Weekend	<input checked="" type="radio"/> Saturday and Sunday <input type="radio"/> Only Sunday				
---------------------------------	---------------------------------	----------------------------------	----------------------------------	----------------------------------	---	---------------------------------	----------------------------------	----------------------------------	----------------------------------	---	---------------------------------	----------------------------------	----------------------------------	----------------------------------	--	--	--	--	--	--

**Connection Status**

Status: Connected. Connected Time: Mon Sep 20 14:09:21 2010

Figure 20-17

To enable the VSM connection:

1. **Activate Link:** Enable the monitoring through VSM.
2. **Host Name or IP Address:** Type the host name or IP address of VSM.
3. **Port Number:** Match the port to the Port 2 value on VSM. Or keep the default value 5609.
4. **User Name:** Type a valid username to log into VSM.
5. **Password:** Type a valid password to log into VSM.
6. Click **Apply**. The Connection Status should display “Connected” and connected time.
7. To establish connection to the second VSM, click the **Connection 2** tab and repeat the above steps for setup.

These options you can also find on this VSM setting page:

- **Cease motion detection messages from:** Stops notifying VSM of motion-triggered events.
- **Cease input trigger messages from:** Note this function is only supported by cameras with I/O function. Stops notifying VSM of input-triggered events.
- **Enable schedule mode:** Starts the monitoring through VSM based on the schedule you set in the **Select Schedule Time** section. Refer to *20.5 Recording Schedule* for the same settings.

For related settings to activate the monitoring through VSM, see *20.1.2 Motion Detection* and *20.2.1 Input Settings*, and *24.2 VSM*.

## 20.3.5 Backup Center

For the supported version of different models, see *Appendix D*. Note that Backup Center is not supported for **Target Series**.

The connection to the GV-Backup Center allows you to back up another copy of recordings and system log to the GV-Backup Center on an offsite location while the camera is saving these data to the memory card. The GV-Backup Center provides a PC-based storage and backup solution. For details on the GV-Backup Center, see *GV-Backup Center User's Manual*.

### Backup Center

In this section you can configure the connection to Backup Center and tasks to perform

**Backup Center**

Activate Link

Host name or IP Address:

Port number:

User Name:

Password:

Backup Video

Compact Video

Resend all files

Automatic Failover Support

Host name or IP Address:

Port number:

User Name:

Password:

Enable schedule mode

**Select schedule time**

Span 1     Next Day

Span 2     Next Day

Span 3     Next Day

Weekend  Saturday and Sunday  Only Sunday

**Connection Status**

Status: Disconnected

Figure 20-18



To enable connection to GV-Backup Center:

1. **Activate Link:** Enable the connection to the GV-Backup Center.
2. **Host Name or IP Address:** Type the host name or IP address of the GV-Backup Center.
3. **Port Number:** Match the communication port on the GV-Backup Center or keep the default value **30000**.
4. **User Name:** Type a valid user name to log into the GV-Backup Center.
5. **Password:** Type a valid password to log into the GV-Backup Center.
6. **Backup Video:** Select the streams to back up their recordings to the GV-Backup Center.
7. **Compact Video:** Select the streams to only back up their Key Frames to the GV-Backup Center, instead of full recordings. This option is useful to save the backup time.
8. **Resend all files:** Select this option to send all the recorded files that have received by the Backup Center again.
9. **Enable Schedule Mode:** Enable the GV-Backup Center connection on the schedule you set in the Select Schedule Time section. Refer to *20.5 Recording Schedule* for the same settings.
10. Click **Apply**. The Connection Status should display “Connected” and connected time.

If you have a failover GV-Backup Center server which provides uninterrupted backup services in case the first GV-Backup Center failed, configure the failover GV-Backup Center as below.

1. **Automatic Failover Support:** Enable the automatic connection to the failover GV-Backup Center once the connection between camera and the first GV-Backup Center is interrupted.

2. **Host Name or IP Address:** Type the host name or IP address of the failover GV-Backup Center.
3. **Port Number:** Match the communication port on the failover GV-Backup Center or keep the default value **30000**.
4. **User Name:** Type a valid user name to log into the failover GV-Backup Center.
5. **Password:** Type a valid password to log into the failover GV-Backup Center.
6. Click **Apply**.

## 20.3.6 Video Gateway / Recording Server

For the supported version of different models, see *Appendix D*.

The GV-Video Gateway / GV-Recording Server is a video streaming server designed for large-scale video surveillance deployments. The GV-Video Gateway / GV-Recording Server (with recording capability) can receive up to **128** channels from various IP video devices, and distribute up to **300** channels to its clients. With the GV-Video Gateway / GV-Recording Server, the desired frame rate can be ensured while the CPU loading and bandwidth usage of the IP video devices are significantly reduced.

Connection 1
Connection 2

### Video Gateway / Recording Server

In this section you can configure the connection to Video Gateway / Recording Server.

To notify the Video Gateway/Recording Server upon motions, be sure to set up the detection area on the Motion Detection page.

**Video Gateway / Recording Server**

Activate Link

Host name or IP Address:

Port number:

User Name:

Password:

Enable schedule mode

**Select schedule time**

Span 1     Next Day

Span 2     Next Day

Span 3     Next Day

Weekend  Saturday and Sunday  Only Sunday

**Connection Status**

Status: Disconnected

Figure 20-19

The supported GV-IPCAM H.264 can connect up to two GV-Video Gateway / GV-Recording Server. To send the video images to the GV-Video Gateway or GV-Recording Server, follow the steps below.

1. **Activate Link:** Enable the connection to the GV-Video Gateway / GV-Recording Server.
2. **Host Name or IP Address:** Type the host name or IP address of the GV-Video Gateway / GV-Recording Server.
3. **Port Number:** Match the communication port on the GV-Video Gateway / GV-Recording Server or keep the default value **50000**.
4. **User Name:** Type a valid user name to log into the GV-Video Gateway / GV-Recording Server.
5. **Password:** Type a valid password to log into the GV-Video Gateway / GV-Recording Server.
6. **Enable Schedule mode:** Enable the GV-Video Gateway / GV-Recording Server on the schedule you set in the **Select Schedule Time** section. Refer to *20.5 Recording Schedule* for the same settings.
7. Click **Apply**. The Connection Status should display "Connected" and the connected time.
8. To establish connection to the second GV-Video Gateway / GV-Recording Server, click the **Connection 2** tab and repeat the above steps for setup.

## 20.3.7 ViewLog Server

Note that ViewLog Server is not supported for **Target Series**.

The ViewLog Server is designed for remote playback function. This server allows you to remotely access the recorded files saved at the GV-IPCAM H.264 and play back video with the ViewLog player.

This function is enabled by default using port **5552**. Keep the default setting and only modify it when necessary. For details on the remote playback, see *21.2.2 Playback over Network*.

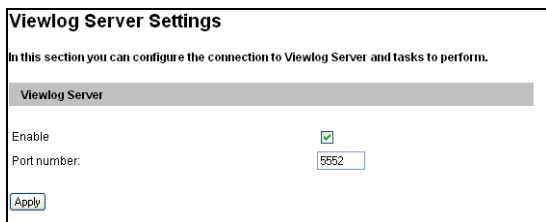

**Viewlog Server Settings**

In this section you can configure the connection to Viewlog Server and tasks to perform.

**Viewlog Server**

Enable

Port number:

Figure 20-20

### 20.3.8 RTSP

The RTSP enables video and audio streaming to your 3G-enabled mobile phone. The RTSP streaming is enabled by default.

**RTSP**

**RTSP Server**

Activate Link

RTSP/TCP port

RTP/UDP port  ~

Max connection

Enable Audio

Disable Authentication

Figure 20-21

- **Activate Link:** Enable the RTSP service.
- **RTSP/TCP Port:** Keep the default value 8554, or modify it if necessary.
- **RTP/UDP Port:** Keep the default range from 17300 to 17319, or modify it if necessary. The number of ports for use is limited to 20.
- **Max Connection:** Set the maximum number of RTSP and 3GPP connections to the GV-IPCAM H.264. The maximum value is 8.
- **Enable Audio:** Note this function is not available for **Target Bullet Camera** and **Ultra Bullet Camera**. Turns audio streaming on or off. For the supported firmware versions, see *Appendix D*.
- **Disable Authentication:** By default, when accessing live view through RTSP command, the ID and password of the camera are required. Select this option to disable the authentication prompt. For the supported firmware versions, see *Appendix D*.

For details on remote monitoring with mobile phones, see *Mobile Phone Connection, Chapter 25*. For RTSP command, see *Appendix E*.

## 20.3.9 Speaker

Note this function is only available for **Advanced Cube Camera**.

The Advanced Cube camera is equipped with an alarm. With the Speaker settings, your camera can sound the speaker (No. 1, Figure 17-1) when it is being tampered or when motions are detected. This function is disabled by default.

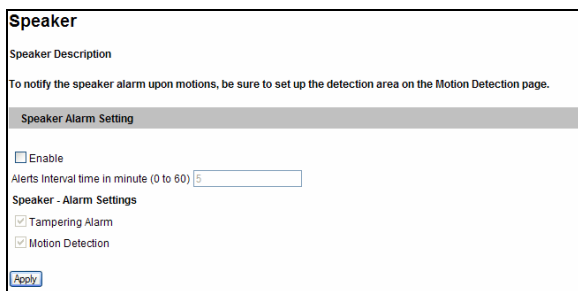

**Speaker**

Speaker Description

To notify the speaker alarm upon motions, be sure to set up the detection area on the Motion Detection page.

**Speaker Alarm Setting**

Enable

Alerts Interval time in minute (0 to 60)

**Speaker - Alarm Settings**

Tampering Alarm

Motion Detection

Figure 20-22

1. Select **Enable**.
2. Type the duration time in the Alerts Interval time field. The default value is **5** (minutes). When a motion is detected, the alarm will be on for the specified amount of time.
3. Select **Tampering Alarm** and/or **Motion Detection** under Alarm Settings.

To sound the alarm upon motion events, make sure you have enabled motion detection. For details, see *20.1.2 Motion Detection*.

## 20.4 Monitoring

Recording function is not supported in **Target Series**. Refer to *20.4.1 Monitoring Settings for Target Series* for the corresponding page.

You can start monitoring manually, by schedule or by input trigger.

---

**Note:** See *Note for Connecting to GV-System* at the beginning of the manual.

---

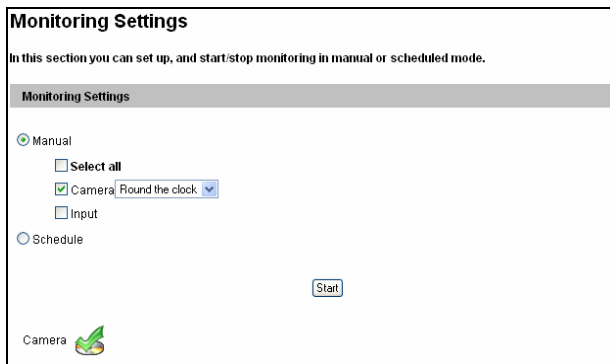

Figure 20-23

**[Manual]** Manually activates motion detection and I/O monitoring. Select one of the following options and then click the **Start** button.

- **Select all:** Manually starts both motion detection and I/O monitoring.
- **Camera:** Manually starts recording. Select the desired recording mode for recording.



- **Input:** Note this function is only supported by cameras with I/O function. Manually starts I/O monitoring. When the sensor input is triggered, its associated camera and output will be activated for recording and alerting. For this setting, see *20.2.1 Input Setting*.

**[Schedule]** The system starts motion detection and I/O monitoring according to the schedule you have set. For schedule settings, see *20.5 Recording Schedule*.

### **[Camera Status Icon]**



: On standby



: Enabled for motion detection and input trigger



: Recording is on.

## **20.4.1 Monitoring Settings for Target Series**

In the Monitoring Settings page for Target Series, click **Start** to activate e-mail and FTP alert functions. Be sure to complete related settings on the Motion Detection and FTP page.

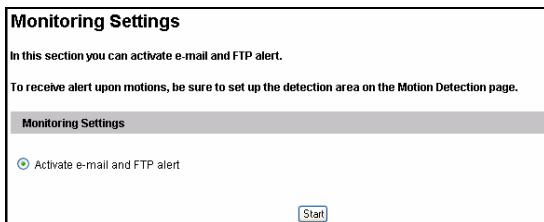

*Figure 20-24*

## 20.5 Recording Schedule

Note this function is not available for **Target Series**.

The schedule is provided to activate recording and I/O monitoring on a specific time each day.

### 20.5.1 Recording Schedule Settings

You can set the schedule for recording.

**Recording Schedule Settings**

In this section you can configure schedule time.

**Select schedule time**

Span 1 Round the clock [v] [00] [v] [00] [v] [00] [v] [00] [v] Next Day

Span 2 Round the clock [v] [00] [v] [00] [v] [00] [v] [00] [v] Next Day

Span 3 Round the clock [v] [00] [v] [00] [v] [00] [v] [00] [v] Next Day

Weekend Round the clock [v]  Saturday and Sunday  Only Sunday

Special Day Round the clock [v] (MM/DD)

01. [ ] 02. [ ] 03. [ ] 04. [ ]

05. [ ] 06. [ ] 07. [ ] 08. [ ]

09. [ ] 10. [ ] 11. [ ] 12. [ ]

[Apply]

Figure 20-25

- **Span 1- Span 3:** Set a different recording mode for each time frame during the day. Each day can be divided into 3 time frames, represented by Span 1 to Span 3.
- **Weekend:** Enable this option to start monitoring all day on the weekend and select the recording mode to be used. Define whether your weekend includes **Saturday and Sunday** or **Only Sunday**.
- **Special Day:** Set the recording mode on a specified day.

## 20.5.2 I/O Monitoring Settings

Note this function is only supported by cameras with I/O function.

You can set the schedule for I/O monitoring to start.

### I/O Monitor Settings

In this section you can configure I/O monitor time.

Select monitor time

Span 1    01 : 00 ~ 08 : 00  
 Span 2    19 : 00 ~ 01 : 00 Next Day  
 Span 3    00 : 00 ~ 00 : 00 Next Day

Weekend     Saturday and Sunday     Only Sunday

Special Day (MM/DD)

01. <input style="width: 40px;" type="text"/>	02. <input style="width: 40px;" type="text"/>	03. <input style="width: 40px;" type="text"/>	04. <input style="width: 40px;" type="text"/>
05. <input style="width: 40px;" type="text"/>	06. <input style="width: 40px;" type="text"/>	07. <input style="width: 40px;" type="text"/>	08. <input style="width: 40px;" type="text"/>
09. <input style="width: 40px;" type="text"/>	10. <input style="width: 40px;" type="text"/>	11. <input style="width: 40px;" type="text"/>	12. <input style="width: 40px;" type="text"/>

Figure 20-26

- **Span 1- Span 3:** Set different time frames during the day to enable I/O monitoring. Each day can be divided into 3 time frames, represented by Span 1 to Span 3.
- **Weekend:** Enable this option to start I/O monitoring all day on the weekend and define whether your weekend includes **Saturday and Sunday** or **Only Sunday**.
- **Special Day:** Enable I/O monitoring on a specified day.

---

**Note:** In Recording Schedule and I/O Monitoring Schedule, if the settings for Special Day conflict with those for Span 1-3 or Weekend, the Special Day settings will get the priority.

---

## 20.6 Remote ViewLog

Note this function is not available for **Target Series**.

With the Remote ViewLog player, you can play back the files recorded at the GV-IPCAM H.264 over TCP/IP network.

For the first-time user, you need to install the Remote ViewLog program from the Software CD. To allow remote access to the camera, make sure the ViewLog Server function is enabled. See *20.3.7 ViewLog Server*.

For details on connecting to the camera for playback, see *21.2.2 Playback over Network*.

## 20.7 Network

The Network section includes some basic but important network configurations that enable the camera to be connected to a TCP/IP network.

### 20.7.1 LAN Configuration

According to your network environment, select among Static IP, DHCP and PPPoE.

#### LAN Configuration

In this section you can configure GV-IPCAM to work inside of LAN.

---

**Optional Network type**

Wired Ethernet Select this option to use wired 10/100Mbps ethernet  
 Wireless Select this option to use Wireless

---

**LAN Configuration**

Dynamic IP address Select this option to obtain IP address from a DHCP server Test DHCP  
 Static IP address Select this option to enter a Static IP address manually

IP Address:   
 Subnet Mask:   
 Router/Gateway:   
 Primary DNS:   
 Secondary DNS:  (Optional)

PPPoE Select this option to establish a DSL connection  
 Username:   
 Password:

---

**Wireless Settings**

Dynamic IP address Select this option to obtain IP address from a DHCP server Test DHCP  
 Static IP address Select this option to enter a Static IP address manually

IP Address:   
 Subnet Mask:   
 Router/Gateway:   
 Primary DNS:   
 Secondary DNS:  (Optional)

Figure 20-27

**[Optional Network Type]**

Note the Wireless Settings are only available in **GV-BX1200 Series / 1300 Series / 1500 Series / 2400 Series / 2500 Series / 3400 Series / 5300 Series, GV-CBW120 / 220, GV-CAW120 / 220 and GV-MFD1501 Series / 2401 Series / 2501 Series / 3401 Series / 5301 Series**. According to the network environment, select **Wired Ethernet** or **Wireless**. Before enabling the **Wireless** option, follow the steps in *18.1.3 Configuring the Wireless Connection* to configure the wireless settings first.

**[LAN Configuration]**

- **Dynamic IP address:** The network environment has a DHCP server which will automatically assign a dynamic IP address to the camera. Click the **Test DHCP** button to see the currently assigned IP address or look up the dynamic IP address using GV-IP Device Utility.
- **Static IP address:** Assign a static IP or fixed IP to the camera and fill out the required settings. The default values are as below.

	Wired Ethernet	Wireless
IP address	192.168.0.10	192.168.100.10
Subnet Mask	255.255.255.0	255.255.255.0
Router/Gateway	192.168.0.1	192.168.0.1
Primary DNS server	192.168.0.1	192.168.0.1
Secondary DNS server	192.168.0.2	192.168.0.2

- **PPPoE:** The network environment is xDSL connection. Type the Username and Password provided by ISP to establish the connection. If you use the xDSL connection with dynamic IP addresses, first use the DDNS function to obtain a domain name linking to the camera's changing IP address.

For details on Dynamic DNS Server Settings, see *20.7.3 Advanced TCP/IP*.

## 20.7.2 Wireless Client Mode

Note this function is only supported in **GV-BX1200 Series / 1300 Series / 1500 Series / 2400 Series / 2500 Series / 3400 Series / 5300, GV-CBW120 / 220, GV-CAW120 / 220 and GV-MFD1501 Series / 2401 Series / 2501 Series / 3401 Series / 5301 Series** and when GV-WiFi Adapter is installed. Set up the client mode before enabling the wireless function.

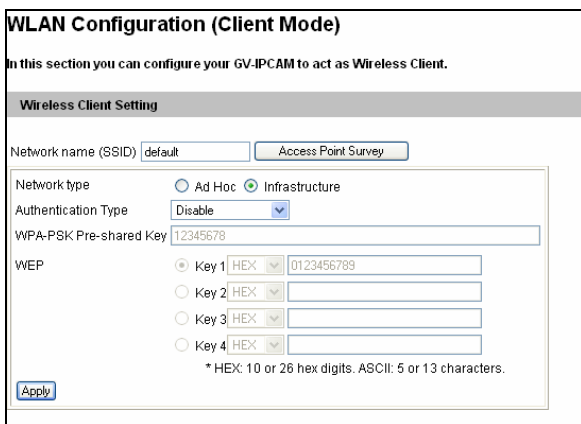

Figure 20-28

- **Network type:** Select the network mode **Ad Hoc** or **Infrastructure**.
  - **Infrastructure:** Connect to the Internet via the Access Point. This mode further gives wireless access to the Internet or data sharing under a previously wired environment.
  - **Ad-Hoc:** A Peer-to-Peer mode. This mode connects to other computer with the WLAN card, and does not need the Access Point to connect to each other.

- **Network name (SSID):** The SSID (Service Set Identify) is a unique name that identifies a particular wireless network. Type SSID of the Wireless LAN group or Access Point you are going to connect to.
- **Access Point Survey:** Click this button to search all the available Access Points (Infrastructure mode) and wireless stations (AD-Hoc mode) within the LAN.
- **Authentication Type:** Select one of these network authentication and data encryption: **Disable**, **WEP**, **WPAPSK-TKIP**, **WPAPSK-AES**, **WPA2PSK-TKIP** or **WPA2PSK-AES**.
  - **Disabled:** No authentication is needed within the wireless network.
  - **WEP (Wired Equivalent Privacy):** A type of data encryption. Type up to four WEP Keys in HEX or ASCII format. Note that if you use HEX format, only digits 0-9 and letters A-F, a-f are valid.
  - **WPAPSK-TKIP and WPA2PSK-TKIP:** Type WPA-PSK (Pre-Shared Key) for data encryption.
  - **WPAPSK-AES and WPA2PSK-AES:** Type WPA-PSK (Pre-Shared Key) for data encryption.

For step-by-step instruction on wireless connection, see *18.1.3 Configuring the Wireless Connection*.

---

**Note:**

1. Your encryption settings must match those used by the Access Points or wireless stations with which you want to associate.
  2. When you lose the wireless access, you can still access the unit by connecting it to a LAN and search for the camera using GV IP Device Utility.
  3. When **Ad Hoc** is used, only **WEP** encryption is supported.
-



## 20.7.3 Advanced TCP/IP

This section provides the advanced TCP/IP settings, including DDNS Server, HTTP port, HTTPS, streaming port, UPnP, QoS and network connection check.

### Advanced TCP/IP

In this section you can set the advanced TCP/IP configuration

**Dynamic DNS Server Settings**

In this section you can configure your GV-IPCAM to obtain a domain name by using a dynamic IP.

Enable

Service Provider: GeoVision DDNS Server [Register GeoVision DDNS Server](#)

Host Name:

User Name:

Password:

Update Time: [Refresh](#)

**HTTP Port Settings**

In this section you can change the default HTTP port number (80) to any port within the range 1024-65535. It is a simple method to increase system security using port mapping. You can configure HTTP connection to an alternative port.

HTTP Port:

**HTTPS Settings**

In this section you can change the default HTTPS port number (443) to any port within the range 1024-65535. It is a simple method to increase system security using port mapping. You can configure HTTPS connection to an alternative port.

Enable

HTTPS Port:

External storage is not available. Cannot upload customized certification and private key

Use customized certification and private key. External storage is necessary.

Certificate File:

Certificate Key File:

Password:

**GV-IPCAM Streaming Port Settings**

In this section you can configure Streaming connection from a determine port. The default setting is 10000.

VSS Port:

Figure 20-29A

The screenshot displays three sections of the camera's configuration interface:

- UPnP Settings:** A header bar followed by the text "In this section you can enable or disable UPnP function." Below this, the "UPnP" label is followed by two radio buttons: "Enable" (which is selected) and "Disable". An "Apply" button is located below the radio buttons.
- QoS Settings:** A header bar followed by the text "QoS DSCP Settings. The DSCP value can be in decimal or hexadecimal format between 0-63". Below this, the "DSCP Value" label is followed by a text input field containing the number "0". An "Apply" button is located below the input field.
- Network Connection Check Settings:** A header bar followed by the text "Enable or disable the network connection check. If the network connection failure to function, the camera will reboot automatically in response." Below this, there is a checked checkbox followed by the label "Enable". An "Apply" button is located below the checkbox.

Figure 20-29B

**[Dynamic DNS Server Settings]** DDNS (Dynamic Domain Name System) provides a convenient way of accessing the camera when using a dynamic IP. DDNS assigns a domain name to the camera, so that the Administrator does not need to go through the trouble of checking if the IP address assigned by DHCP Server or ISP (in xDSL connection) has changed. Before enabling the following DDNS function, the Administrator should have applied for a Host Name from the DDNS service provider's website. There are 2 providers listed in the camera: GeoVision DDNS Server and DynDNS.org.

**To enable the DDNS function:**

1. **Enable:** Enable the DDNS function.
2. **Service Provider:** Select the DDNS service provider you have registered with.

3. **Host Name:** Type the host name used to link to the camera. For the users of GeoVision DDNS Server, it is unnecessary to fill the field because the host name will be detected and brought up automatically.
4. **User Name:** Type the username used to enable the service from the DDNS.
5. **Password:** Type the password used to enable the service from the DDNS.
6. Click **Apply**.

**[HTTP Port Settings]** The HTTP port enables connection of the camera to the web. For security integration, the Administrator can hide the server from the general HTTP port by changing the default HTTP port of 80 to a different port number within the range of 1024 through 65535.

---

**Note:** The .pem file format is supported by Certificate and Private Key.

---

**[GV-IPCAM Streaming Port Settings]** The VSS port enables connecting the camera to the GV-System. The default setting is **10000**.

**[UPnP Settings]** UPnP (Universal Plug & Play) is a networking architecture that provides compatibility among networking equipment, software and peripherals of the 400+ vendors that are part of the Universal Plug and Play Forum. It means that they are listed in the network devices table for the operating system (such as Windows XP) supported by this function. Enabling this function means you can connect to the camera directly by clicking on the camera listed in the network devices table.

**[QoS Settings]** The Quality of Service (QoS) is a bandwidth control mechanism that guarantees delay-sensitive data flows such as voice and video streams, obtain a certain amount of bandwidth to keep the streaming smooth.

To apply QoS to GV-IPCAM H.264, all network routers must support QoS and QoS must be enabled on these devices. To enable the QoS on GV-IPCAM H.264, enter a Differentiated Services Code Point (DSCP) value. This value is a field in an IP packet that enables different levels of services for the network traffic. When the video stream from GV-IPCAM H.264 reaches a router, the DSCP value will tell the router what service level to be applied, e.g. the bandwidth amount. This value ranges from 0 to 63 in decimal format. The default value is 0, meaning QoS is disabled.

**[Network Connection Check Settings]** The camera checks for Internet connection, and reboots when it is disconnected from the Internet. This function is enabled by default.

---

**Note:** If you do not intend to connect the camera to the network, disable this function to prevent automatic reboot.

---

## 20.7.4 IP Filter Settings

The Administrator can set IP filtering to restrict access to the camera.

### IP Filter Setting

In this section you can allow or deny network connection listed in the table. (Only 4 filter entries are supported.)

IP Filtering

Enable IP Filtering

No.	IP Address Range in CIDR format	Action	Customize
1	192.168.2.100	Allow	<a href="#">Remove</a>

Filtered IP:  ex: 192.168.1.2 or 192.168.1.0/24

Action to take:

Figure 20-30

To enable the IP Filter function:

1. **Enable IP Filtering:** Enable the IP Filter function.
2. **Filtered IP:** Type one IP address or a range of IP addresses you want to restrict the access.
3. **Action to take:** Select the action of **Allow** or **Deny** to be taken for the IP address(es) you have specified.
4. Click **Apply**.

## 20.7.5 SNMP Settings

The Simple Network Management Protocol (SNMP) allows you to monitor the status of the camera through SNMP network management software.

### SNMP Setting

In this section you can configure the SNMP settings.

#### SNMP Configuration

Enable SNMPv1, SNMPv2c

Read/Write community

Read only community

Enable SNMPv3

Read/Write Security name

Authentication Type

Authentication Password

Encryption Password

Read only Security name

Authentication Type

Authentication Password

Encryption Password

Figure 20-31

1. Select **Enable SNMPv1 SNMPv2c** to enable the function.
2. To enable access to **Read/Write community**, type a community string. This will serve as a password to allow read and write access to the camera from the SNMP software.
3. To enable **Read only community**, type a community string to allow read-only access to the camera from the SNMP software.
4. For a more secured connection, select **Enable SNMPv3** to enable SNMP version 3.
5. To enable access to SNMPv3 **Read/Write community**, type a community string.
6. Select an **Authentication Type** to use for SNMP requests.
7. Type the **Authentication Password** and **Encryption Password**. You will need to type these passwords in the SNMP software to be able to access the camera.
8. To enable access to SNMPv3 **Read only community**, follow steps 5 ~ 7.
9. Click **Apply** to save the settings.

## 20.8 Management

The Management section includes the settings of data and time and user account. You can also view the firmware version and execute certain system operations.

### 20.8.1 Date & Time Settings

The date and time settings are used for date and time stamps on the image.

#### Date and Time Settings

In this section you can configure time and date or just synchronize with a NTP server.

**Date and Time on GV-IPCAM**

Sat Sep 18 15:05:30 2010

**Time Zone**

[GMT+08:00] China,Hong Kong,Australia W/estern,Singapore,Taiwan,Russia ▾

Enable Daylight Saving Time

Start  (MM/dd/hh:mm)

End  (MM/dd/hh:mm)

**Synchronized with a Network Time Server**

Synchronized with Network Time Server (NTP)

Host name or IP Address:

Update period: 24 hours; Update Time:  :

**Synchronized with your computer or modify manually**

Modify manually

Date  (yyyy/mm/dd)

Time  (hh:mm:ss)

Synchronized with your computer

**Date and time overlay setting**

Show date as  ▾

(This is a format of date where yyyy stands for year in 4 digits or yy in 2 digits, mm stands for month, and dd stands for day)

Display order

Date prior to time (Ex 2007/05/21 17:00:00)

Time prior to date(Ex:17:00:00 2007/05/21)

Figure 20-32



**[Date & Time on GV-IP Camera]** Displays the current date and time on the camera.

**[Time Zone]** Sets the time zone for local settings. Select **Enable Daylight Saving Time** to automatically adjust the camera for daylight saving time. Type the Start Time and End Time to enable the daylight saving function. To play back, see *21.2.4 Playback of Daylight Saving Time Events*. To automatically synchronize the Daylight Saving Time with the GV-System, see *23.1.1 Customizing IP Camera Settings*.

**[Synchronized with a Network Time Server]** By default, the camera uses the timeserver of [time.windows.com](http://time.windows.com) to automatically update its internal clock every 24 hours. You can change the host name or IP setting to the timeserver of interest, and specify a time for time update.

**[Synchronized with your computer or modify manually]** Manually changes the camera's date and time. Or, synchronize the camera's date and time with those of the local computer.

**[Date and Time Overlay Setting]** Select the display format of date and time stamps on the image. For this function to work, you must also enable the **Overlaid with date stamps** and **Overlaid with time stamps** options in Figure 20-2.

## 20.8.2 Storage Settings

Note this function is not available for **Target Series**.

Based on Linux file system, the GV-IPCAM H.264 supports memory cards for video and audio recordings. You need to format the storage device by using the following Storage Settings. After being formatted, the storage device will be ready to use by Linux OS of the camera.

### Storage Settings

In this section you can configure the disk storage to archive videos and events.

**Storage Settings**

Enable recycling  
 Stop recording or recycle disk when free space of disk is smaller than 256M

Keep days (1-255) 30

Record Disk Type Default

Enable debug message to the storage.

Enable auto formatting when disk or partition is unable to record.

Apply

**Disk Information**

Disk No.	Total Size	Used Size	Free space	Utilization	Remove	Format
Disk0	1862.852	2.841	1860.010	0%	<span style="border: 1px solid gray; padding: 2px;">Remove</span>	<span style="border: 1px solid gray; padding: 2px;">Format</span>

**Partition Information**

Disk No.	Partition No.	Total Size	Used Size	Free space	Utilization	Status	Other
Disk0	10	195.298	0.196	195.102	0%	OK	<span style="border: 1px solid gray; padding: 2px;">Format</span>
Disk0	11	195.298	0.183	195.115	0%	OK	<span style="border: 1px solid gray; padding: 2px;">Format</span>
Disk0	12	195.298	0.183	195.115	0%	OK	<span style="border: 1px solid gray; padding: 2px;">Format</span>
Disk0	13	195.298	0.183	195.115	0%	OK	<span style="border: 1px solid gray; padding: 2px;">Format</span>
Disk0	14	105.148	0.183	104.965	0%	OK	<span style="border: 1px solid gray; padding: 2px;">Format</span>
Disk0	5	195.298	1.160	194.137	0%	OK	<span style="border: 1px solid gray; padding: 2px;">Format</span>
Disk0	6	195.298	0.182	195.115	0%	OK	<span style="border: 1px solid gray; padding: 2px;">Format</span>
Disk0	7	195.298	0.183	195.115	0%	OK	<span style="border: 1px solid gray; padding: 2px;">Format</span>
Disk0	8	195.298	0.103	195.115	0%	OK	<span style="border: 1px solid gray; padding: 2px;">Format</span>
Disk0	9	195.298	0.183	195.115	0%	OK	<span style="border: 1px solid gray; padding: 2px;">Format</span>

**Network Neighborhood Disk Information**

Disk No.	Total Size	Used Size	Free space	Utilization
No HDD connected				

(Unit: Gigabyte)

Figure 20-33

### [Storage Settings]

- **Enable recycling:** If **Enable recycling** is selected, when the space of the storage device is lower than the specified space, the system will overwrite the oldest recorded files. If **Enable recycling** is not selected, the system will stop recording when the specified space is reached.
- **Keep days (1-255):** Specify the number of days to keep the files from **1** day to **255** days. When both **Keep days** and **Enable recycling** are selected, the system applies whichever condition comes first. For example, if the specified smallest amount of storage space comes earlier than the designated keep days, then recycle is applied first.
- **Enable debug message to the storage:** Debug message (see *20.8.4 Log Information*) is deleted after reboot. Select this option to store log information to an inserted storage device.
- **Enable auto formatting when disk or partition is enable to record:** Select this option for the camera to automatically format the storage device when there is error during recording.

### [Disk Information]

This section shows the details of the attached storage device. Use the **Format/Remove** button to format or unload a storage device. For detail steps, see *Partition Information* below.

### [Partition Information]

This section shows the partition details of the attached storage device.

To add a storage device:

1. Insert the storage device to the camera.
2. Click the **Format** button.
3. After the format is complete, the partition information will display. The maximum space for one partition is 200 GB.

To remove a storage device:

1. Click the **Remove** button.
2. When you are prompted to ensure the action, click **Yes**. The page will be refreshed and the partition information will be cleaned.
3. Remove the storage device from the camera.

The storage device status is indicated in the status column:

Status	Description
Formatting	The storage device is being formatted.
Unknown	The camera can not recognize the format of the storage device or the device can not be found.
OK	Storage formatting is successful.
Try Mount	The camera is attempting to connect to the storage device.
Error File System	There is a recording error in the storage device. All the recording data is inaccessible under the status.
Read Only	The storage device cannot be written due to abnormal power disruption.
Repairing	The system is attempting to repair the recording data.

---

**Note:**

1. If **Enable Recycle** is selected, the available space of the storage device must be higher than the space you specified at the **Stop recording or recycle disk when free space of disk is smaller than x** option. Otherwise no video will be recorded.
2. The recording data may be lost if you remove the storage device during recording.
3. If you do not remove the storage device properly, the data cannot be read in another computer. In this case, re-plug the storage device back to the camera. The system will repair the data automatically. When the system is repairing the data, the Remove field will display "Repairing".
4. To upgrade the firmware from versions earlier than V2.07 to the latest version, be sure to back up the recordings on the camera's storage device first before the upgrade, and re-format the memory card after the upgrade. If you have not done so, this warning message appears when you view the Monitoring or Storage Settings' Web interface:

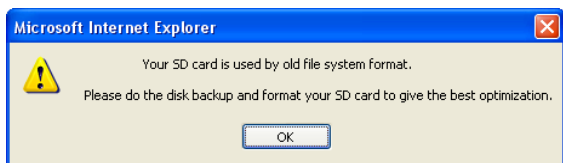

*Figure 20-34*

---

### 20.8.3 User Account

You can change the login name and password of Administrator and Guest. The default Administrator login name and password are **admin**; the default Guest login name and password are **guest**. To allow a Guest user log in without entering name and password, select **Disable authentication for guest account**. To prevent automatic logout of an Administrator / Guest account user after reboot, select **Disable auto logout when reboot**.

#### User Account

In this section you can change the administrator account and password

##### Administrator Account

Username:

Old Password:

New Password:

Confirm Password:

##### Guest User Account

Username:

Old Password:

New Password:

Confirm Password:

Disable authentication for guest account

Disable auto logout when reboot

Figure 20-35

## 20.8.4 Log Information

The log information contains dump data that is used by service personnel for analyzing problems. The logs available may vary depending on the camera model.

### Log Information

In this section you can see all system activities.

**Startup time log**

In this section you can see latest booting time of system.

**Debug Messages**

This section shows the data used for debugging.

```

Oct  3 13:27:17 Video Server[1067]: (1135)
ALG_vidEncSetDynamicParams[1854]: VidEnc: mbMvOutEnable =0
Oct  3 13:27:17 Video Server[1067]: (1135)
ALG_vidEncSetDynamicParams[1856]: VidEnc:
encStatus.bufInfo.minNumInBufs is 2
Oct  3 13:27:17 Video Server[1067]: (1135)
ALG_vidEncSetDynamicParams[1858]: VidEnc: minInBufSize[0] is
[3145728]
Oct  3 13:27:17 Video Server[1067]: (1135)
ALG_vidEncSetDynamicParams[1858]: VidEnc: minInBufSize[1] is
[1572864]
Oct  3 13:27:17 Video Server[1067]: (1135)
ALG_vidEncSetDynamicParams[1860]: VidEnc:
encStatus.bufInfo.minNumOutBufs is 2
Oct  3 13:27:17 Video Server[1067]: (1135)
ALG_vidEncSetDynamicParams[1862]: VidEnc: minOutBufSize[0] is
[4718592]
Oct  3 13:27:17 Video Server[1067]: (1135)
ALG_vidEncSetDynamicParams[1862]: VidEnc: minOutBufSize[1] is
[800]
Oct  3 13:27:22 Video Server[1067]: (1135)
davinci_encoder_rate_control_update[6208]: Encoder Stream Dynamic
Params Update: [Quantization]: QP Down to (37) from (36) ----
Oct  3 13:27:22 Video Server[1067]: (1135)

```

Figure 20-36-1

**System Message**

This section shows the data used for debugging.

```

dwAlarmSpeaker[Off][2], dwSpeakerLevel[80], dwVoiceType[0],
dwAlarmTm[5]
(01067)(10/03/13 11:49:45 2013 GMT8:00): IR Alarm LED: dwEnableLED
[Off][2], dwIR_Level[50], dwIRMode[0], dwFlashTm[60], Auto
Sensitivity[5]
(01067)(10/03/13 11:49:45 2013 GMT8:00): IR Alarm Speaker:
dwAlarmSpeaker[Off][2], dwSpeakerLevel[80], dwVoiceType[0],
dwAlarmTm[5]
(01135)(10/03/13 11:49:46 2013 GMT8:00): CMEM Pool Init: Memory
alloc (6291456)B=(6144)KB for Encoder Stream (0)
(01135)(10/03/13 11:49:46 2013 GMT8:00): CMEM Pool Init: Memory
alloc (655360)B=(640)KB for Encoder Stream (1)
(01135)(10/03/13 11:49:46 2013 GMT8:00): CMEM Pool Init: Memory
alloc (6291456)B=(6144)KB for Snapshot Stream (0)
(01135)(10/03/13 11:49:46 2013 GMT8:00): CMEM Pool Init: Memory
alloc (655360)B=(640)KB for Snapshot Stream (1)
(01135)(10/03/13 11:49:46 2013 GMT8:00): Share Memory Crate :
Memory alloc (6291456)B=(6144)KB for JPEG Stream (0)
(01135)(10/03/13 11:49:46 2013 GMT8:00): Share Memory Crate :
Memory alloc (655360)B=(640)KB for JPEG Stream (1)
(01135)(10/03/13 11:49:46 2013 GMT8:00): CMEM Pool Init: Memory
alloc (327680)B=(320)KB for Scene Decton (1)
(01135)(10/03/13 11:49:46 2013 GMT8:00): CMEM Pool Init: Memory
alloc (327680)B=(320)KB for Motion Detect (1)

```

**Notice Message**

This section shows the data used for debugging.

No Record

Figure 20-36-2



## 20.8.5 System Log

Note this function is not available for **Target Series**. For the supported versions, see *Appendix F*.

The System Log records the events in the four types of logs: **System Event**, **Monitoring Event**, **I/O Event** and **Login/Logout Event**. With the System Log, you can search and obtain the detailed information of an event. To use the System Log, a micro SD card (SD/SDHC, version 2.0 only, Class 10) is required to be inserted to the GV-IP Camera H.264.

1. For the first-time user of the System Log, first click **Create** to create a system log database (access file) on the inserted micro SD card.

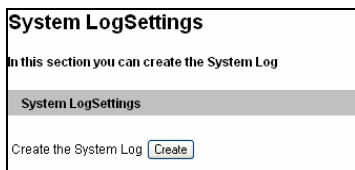

Figure 20-37

---

**Note:** If you have created the system log database on the micro SD card, clicking **Create** again will clean your System Log.

---

2. Select the log type **System Event**, **Monitoring Event**, **I/O Event** or **Login/Logout Event** from the left menu of the Web interface.
3. Select the filtering criteria. For example, we want to know the login and logout information during a specific period of time.

4. Click **Query**. The filtering results may look like the figure below.

Monitor Event Query						
<b>Camera</b>	<input checked="" type="checkbox"/> Select all GV-BL110D <input checked="" type="checkbox"/> Camera <input checked="" type="checkbox"/> Camera		<b>Event Type</b>	Select all <input type="text"/>		
<b>DST</b>	Select all <input type="text"/>		<b>Time</b>	2000-01-01	00	00
				23	59	59
						2000-01-01
<input type="button" value="Query"/> <input type="button" value="Reset"/>						
The page show record 1-15, total number of records : 16 <input type="button" value="&lt;&lt;"/> <input type="button" value="&lt;"/> <input type="button" value="&gt;"/> <input type="button" value="&gt;&gt;"/> Page <input type="text" value=""/> <input type="button" value="go"/> total number of pages : 2						
Query Result List						
Device Name	Camera	Event Type	Time	DST	Video Clip	
GV-BL110D	Camera	Motion	2000-01-01 13:27:59	N	N	
GV-BL110D	Camera	Motion	2000-01-01 13:27:54	N	N	
GV-BL110D	Camera	Motion	2000-01-01 13:27:49	N	N	
GV-BL110D	Camera	Motion	2000-01-01 13:27:45	N	N	

Figure 20-38

## 20.8.6 Tools

You can execute certain system operations and view the firmware version.

### Additional Tools

In this section you can set the additional tools

---

#### Host Settings

In this section you can determine a hostname and camera name for identification.

Host Name

---

#### Auto Reboot Setup

In this section you can set the system's auto reboot time.

Enable

Day Interval  days

RebootTime  :

---

#### Repair Record Database

In this section you can set the system repair record database.

---

#### Repair Database Status

Unknown

---

#### Firmware Update

In this section you can see GV-IPCAM firmware version.

---

#### System Settings

Restore to factory default settings

---

#### Internal Temperature

Internal Temperature Normal Range : 0°C ~ 95°C \*(32°F ~ 203°F)\*

Current internal temperature is  °C /  °F

---

#### Reboot

Do you wish to reboot now?

Figure 20-39

**[Host Settings]** Enter a descriptive name for the camera.

**[Auto Reboot Setup]** Select **Enable** to activate automatic reboot and specify the time for reboot in the sub fields.

- **Day Interval:** Type the day interval between each reboot.
- **Reboot Time:** Use the drop-down lists to specify the time for automatic reboot.

**[Repair Record Database]** Note this function is not available for **Target Series**. Click **Apply** to repair the database when errors occur while playing back the recordings with the Remote ViewLog player. Problems can occur when there are errors in firmware or damages to the micro SD card.

**[Database Status]** Note this function is not available for **Target Series**. Displays the repairing status of database.

**[Firmware Update]** This field displays the firmware version of the camera.

### **[System Settings]**

- **Load Default:** Clicking the **Load Default** button to restore factory default settings. After applying the default settings configure the camera's network setting again.

**[Temperature Status]** Note this function is not available for **Target Series**, **Cube Camera** and **Advanced Cube Camera**. Displays the current chipset temperature inside the camera.

**[Reboot]** Clicking the **Reboot** button will make the camera perform software reset.

## 20.8.7 Language

Note this function is not available in **GV-PTZ010D**.

You can select the language for the Web interface.

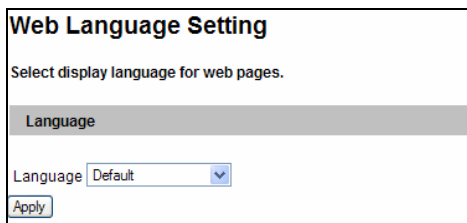

**Web Language Setting**

Select display language for web pages.

**Language**

Language

*Figure 20-40*

Use the **Language** drop-down list to select a language for the Web interface. By default, the language on the Web interface will be the same with the one used for the operating system.

# Chapter 21 Recording and Playback

Note that Recording and Playback function is not available for **Target Series**.

The GV-IPCAM H.264 can record video and audio directly to the memory card. You can play back the recorded files on the GV-System or over the TCP/IP network.

---

**Note:** See *Note for Recording* at the beginning of the manual.

---

## 21.1 Recording

To enable the recording function:

1. Insert the memory card to the camera. See "To add a memory card", *20.8.2 Storage Settings*.
2. If you like to set up the pre-recording, post-recording or audio recording, see *20.1.1 Video Settings*.
3. If you like to set up the schedule for video recording or I/O monitoring, see *20.5 Recording Schedule*.
4. If you like to configure the areas and sensitivity values for motion detection, see *20.1.2 Motion Detection*.
5. If you want the recording to be triggered by input device, configure the operation of input device. See *20.2.1 Input Settings*.
6. To start recording and I/O monitoring, see *20.4 Monitoring*.

The camera will start recording in case of motion detection, I/O trigger, or during the scheduled time.

## 21.2 Playback

These methods are available to play back the video files recorded at the GV-IPCAM H.264:

- Playback from the memory card by connecting it directly to the GV-System through a card reader
- Playback by using the Remote ViewLog function over the TCP/IP network
- Playback by using the recorded files downloaded from built-in FTP Server

### 21.2.1 Playback from the Memory Card

You can play back the files recorded at the GV-IP Camera by connecting the memory card to GV-System through a card reader. However, the videos on GV-IP devices are recorded in the Linux format and GV-System runs on a Windows-based computer. For Linux files to be readable and accessible on Windows, we use the Ext2Fsd program. Follow the steps below to download, install and execute the Ext2Fsd program.

---

#### **IMPORTANT:**

1. Due to the compatibility issue, the Ext2Fsd program is required for GV-IP Camera firmware V2.07 or later.
  2. The Ext2Fsd program only works on Windows 2000, XP, 2003, vista, 7, 8 and Server 2012 (32-bit and 64-bit).
  3. The Ext2Fsd program is subject and under term/condition of The GNU General Public License version 2 (GPLv2). Please read <http://www.gnu.org/licenses/gpl-2.0.html> before installation.
-

1. Install the Ext2Fsd from the Software CD.

---

**Note:** If you are using **Windows 8** or **Windows Server 2012**, change its compatibility before installing the Ext2Fsd program:

- A. Right-click the Ext2Fsd program and select **Properties**. This dialog box appears.

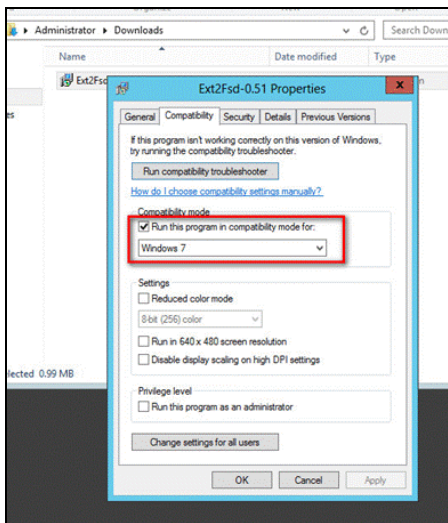

Figure 21-1

- B. Select the **Compatibility** tab.
  - C. Select **Windows 7** using the drop-down list.
-



- On Your desktop, click **Start**, select **Programs**, locate the **Ext2Fsd** folder and select **Ext2 Volume Manager**. All the connected drives are shown.

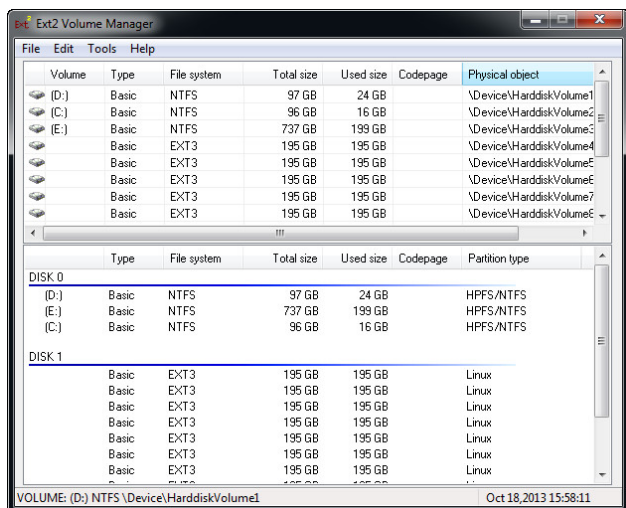

Figure 21-2

3. For the first-installation, execute the Ext2Fsd Service.
  - A. From the Ext2 Volume Manager window, select **Tools** and select **Service Management**. This dialog box appears.

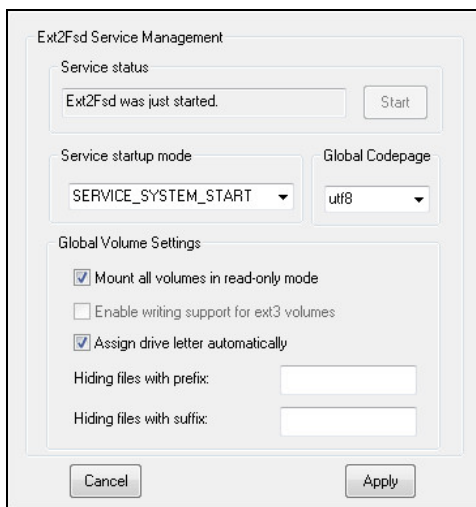

Figure 21-3

- B. Click **Apply**.

4. Mount the storage drive to your computer.
  - A. From the Ext2Fsd Volume Manager window, right-click the storage drive and select **Ext2 Management**. This dialog box appears.

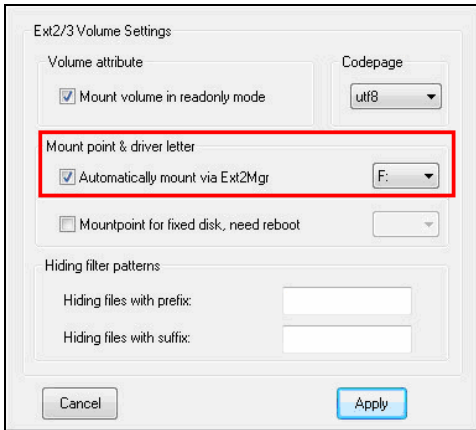

Figure 21-4

- B. Under the Mount point & driver letter section, select **Automatically mount via Ext2Mgr**, specify a disk drive using the drop-down list and click **Apply**.

- C. On the Ext2 Volume Manager window, the storage drive is successfully mounted to your computer when it is indicated with the disk drive you specified.

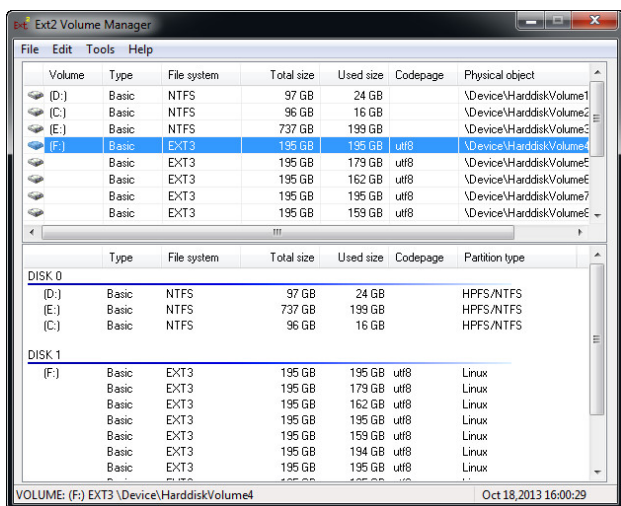

Figure 21-5

5. Access the recording files from the specified drive of your computer.

## 21.2.2 Playback over Network

With the Remote ViewLog function, you can play back the files recorded at the GV-IPCAM H.264 over TCP/IP network.

1. The camera needs to allow the remote access with **ViewLog Server** activated. See 20.3.7 *ViewLog Server*.
2. For the first-time user, run the **Remote ViewLog** program from the Software CD. Next time whenever you like to use this remote playback function, access this option from the camera's Web interface.
3. When the Remote ViewLog player is open, you will be prompted to select Remote ViewLog Service or Remote Storage System. Select **Remote ViewLog Service**.
4. When this dialog box appears, type the camera's IP address, login ID and password. Keep the default port **5552** or modify it if necessary.

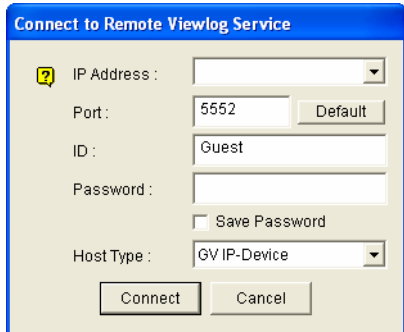

**Connect to Remote Viewlog Service**

? IP Address :

Port :

ID :

Password :

Save Password

Host Type :

*Figure 21-6*

4. In the Host Type field, select **GV-IP Device**.
5. Click **Connect** to access the files of the camera for playback.

### 21.2.3 Access to the Recorded Files through FTP Server

The built-in FTP Server allows you to download the recorded files saved on the memory card. You can play back the downloaded files of AVI format with Media Player. For details to download files, see [Act as FTP Server], 20.3.2 *FTP*.

---

**Note:** To play back videos, ensure you have installed Geovision codec on the computer. The codec is available on the Software CD. If you have installed the Remote Playback player on the computer, it is not required to install the codec.

---

### 21.2.4 Playback of Daylight Saving Time Events

On GV-System, you can retrieve the events recorded during the Daylight Saving Time (DST) period from the GV-IPCAM H.264 for playback. You can also connect the memory card to GV-System for playback.

The following instructions describe how to retrieve the recorded files from the GV-IPCAM H.264 over network. If you like to use the memory card for playback, first follow the instructions in 21.2.1 *Playback Using the Memory Card* to load the recorded files to ViewLog, and then follow Steps 4-5 below to play back DST events.

1. The camera must allow the remote access with **ViewLog Server** activated. See 21.3.7 *ViewLog Server*.

2. To remotely connect to the camera from GV-System, click the **Tools** button and select **Remote ViewLog Service**. The Connect to Remote ViewLog Service dialog box appears.
3. Enter the connection information of the camera, and click **Connect**. Once the connection is established, the video events will be displayed on the Video Event list.
4. On the Date Tree, select the date of Daylight Saving Time. A separate DST subfolder will be displayed as illustrated below.

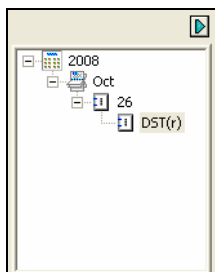

*Figure 21-7*

5. On the Video Event list, select desired events, and click the **Play** button to start.

---

**Note:**

1. The playback function is only compatible with the GV-System of version 8.3 and later.
  2. The AVI file recorded during the DST period is named with the prefix "GvDST", e.g. GvDST20081022xxxxxxxx.avi, to differentiate from the regular AVI file named with the prefix "Event", e.g. Event20081022xxxxxxxx.avi.
-

# Chapter 22 Advanced Applications

This chapter introduces more advanced applications.

## 22.1 Upgrading System Firmware

GeoVision periodically releases updated firmware on the website. Simply download the new firmware into the GV-IPCAM H.264 using the Web interface or IP Device Utility included in the Software CD.

### Important Notes before You Start

Before you start updating the firmware, please read these important notes:

1. To update the camera firmware from versions earlier than V2.07 to the latest version, **back up the recordings on the storage device to another device first** before the upgrade.
2. If you use the IP Device Utility for firmware upgrade, the computer used to upgrade firmware must be under the same network of the camera.
3. Stop monitoring of GV-IPCAM H.264.
4. Stop all the remote connections including Center V2, VSM, ViewLog Server and 3GPP/RTSP.
5. Stop the connection to GV-System.
6. While the firmware is being updated,
  - A) the power supply must not be interrupted, and
  - B) do not unplug the Ethernet cable if the cable is the source of power supply (Power over Ethernet or PoE supported).



---

**WARNING:** The interruption of power supply during updating causes not only update failures but also damages to the camera. In this case, please contact your sales representative and send your device back to GeoVision for repair.

---

7. Do not turn the power off within 10 minutes after the firmware is updated.
8. If firmware upgrade fails, you will need to restore the camera to its default settings. For details, see *22.3 Restoring to Factory Default Settings*.
9. Since the firmware adopts different storage format from V2.07 onward, be sure to re-format the memory card after firmware upgrade. If you have not done so, this warning message appears when you view the Monitoring or Storage Settings' Web interface:

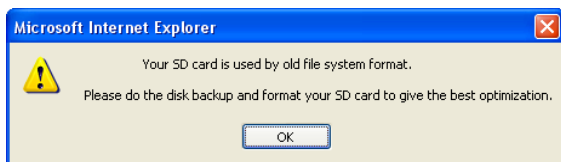

Figure 22-1

## 22.1.1 Using the Web Configuration Interface

1. In the Live View window, click the **Show System Menu** button (No. 8, Figure 19-3) and select **Remote Config**. This dialog box appears.

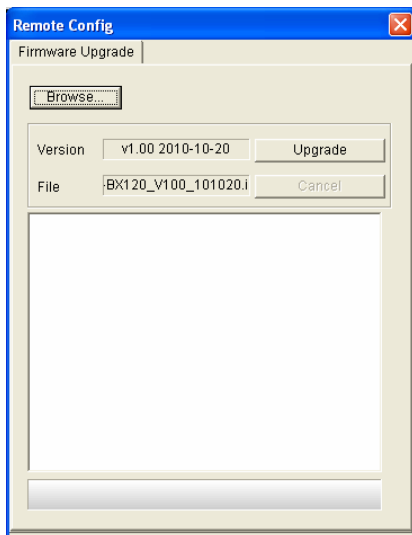

Figure 22-2

2. Click the **Browse** button to locate the firmware file (.img) saved at your local computer.
3. Click the **Upgrade** button to start the upgrade.

## 22.1.2 Using the IP Device Utility

The IP Device Utility provides a direct way to upgrade the firmware to multiple units of GV-IPCAM H.264. Note the computer used to upgrade firmware must be under the same network of the camera.

1. Insert the Software CD, select **GeoVision IP Device Utility**, and follow the onscreen instructions to install the program.
2. Double-click the **IP Device Utility** icon created on your desktop. This dialog box appears.

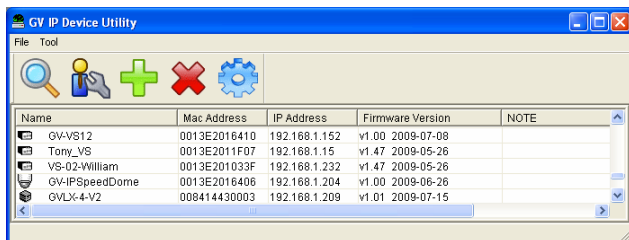

Figure 22-3

3. Click the **Search** button to locate available cameras on the same LAN. Or click the **New** button and assign the IP address to locate the camera over the Internet. Or highlight one camera in the list and click the **Delete** button to remove it.

4. Double-click one camera in the list. This dialog box appears.

Figure 22-4

5. Click the **Firmware Upgrade** tab. This dialog box appears.

Figure 22-5

6. Click the **Browse** button to locate the firmware file (.img) saved at your local computer.
7. If you like to upgrade all the cameras in the list, select **Upgrade all devices**.
8. Type **Password**, and click **Upgrade** to start the upgrade.

## 22.2 Backing Up and Restoring Settings

With the IP Device Utility included in the Software CD, you can back up the configurations in the GV-IPCAM H.264, and restore the backup data to the current camera or import it to another camera.

### To back up the settings:

1. Run **IP Device Utility** and locate the desired camera. See Steps 1-3 in 22.1.2 *Using the IP Device Utility*.
2. Double-click the camera in the list. Figure 19-4 appears.
3. Click the **Export Settings** button. This dialog box appears.

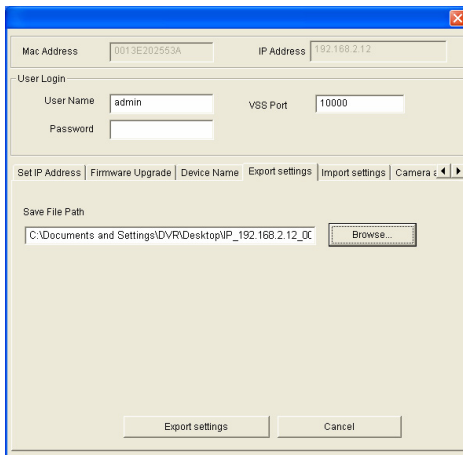

Figure 22-6

4. Click the **Browse** button to assign a file path.
5. Type **Password**, and click the **Export Settings** button to save the backup file.

### To restore the settings:

1. In Figure 22-4, click the **Import Settings** tab. This dialog box appears.

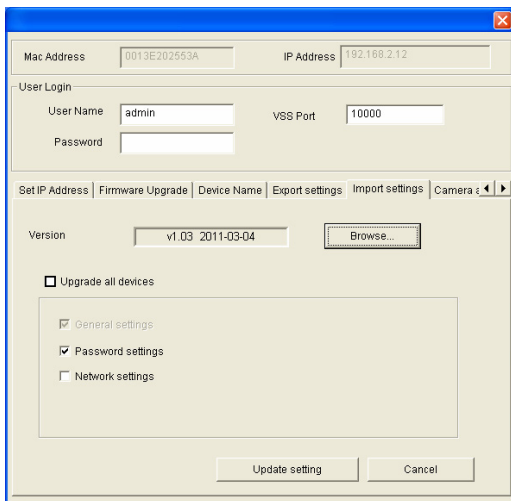

Figure 22-7

2. Click the **Browse** button to locate the backup file (.dat).
3. Select **Upgrade all devices** to import the settings into the same type of device in the same LAN. To import password settings and/or network settings, select **Password Settings** and/or **Network settings**.
4. Click the **Update Settings** button to start restoring.

## 22.3 Restoring to Factory Default Settings

Please refer to the corresponding section of your camera type and follow the steps to restore factory default settings.

### Box Camera

1. Keep the power and network cables connected to the camera.
2. Use a pin to press and hold the **default** button on the back panel of the camera.

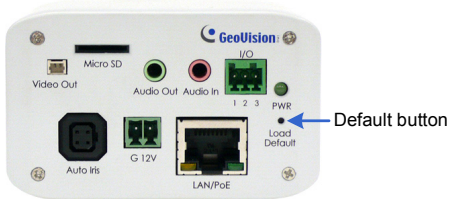

Figure 22-8

3. Release the **default** button when the **status LED** blinks. This shall take about 8 seconds.



Figure 22-9

4. When the **status LED** fades, the process of loading default settings is completed and the camera reboots automatically.

### Ultra Box Camera and Target Box Camera

1. Keep the power and network cables connected to the camera.
2. Use a pin to press and hold the **default** button on the back panel of the camera.

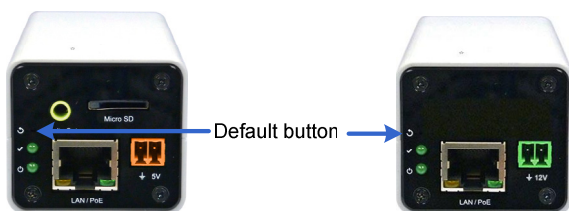

Figure 22-10

3. Release the **default** button when the **status LED** blinks. This shall take about 8 seconds.

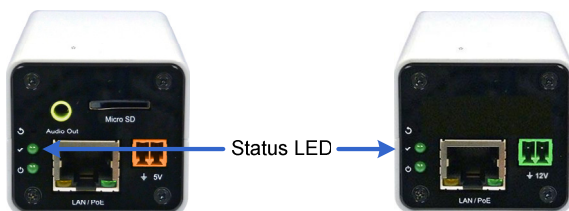

Figure 22-11

4. When the **status LED** fades, the process of loading default settings is completed and the camera reboots automatically. When the status LED turns on (green), the camera is ready for use.



### Mini Fixed Dome

1. Keep the power and network cables (or PoE) connected to the camera.
2. Press and hold the **default** button.



Figure 22-12

(GV-MFD120 / 130 / 220 / 320 / 520)



Figure 22-13

(GV-MFD1501 Series / 2401 Series / 2501 Series / 3401 Series / 5301 Series)

3. Release the **default** button when the **status LED** blinks. This shall take about 8 seconds.
4. When the **status LED** fades, the process of loading default settings is completed and the camera reboots automatically.

### Mini Fixed Rugged Dome

1. Keep the PoE cable connected to the camera.
2. Press and hold the **default** button.

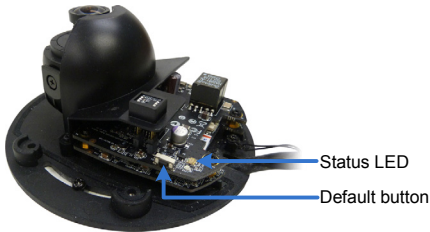

Figure 22-14

3. Release the **default** button when the **status LED** blinks. This shall take about 8 seconds.
4. When the **status LED** fades, the process of loading default settings is completed and the camera reboots automatically.

### Target Mini Fixed Dome

1. Keep the PoE cable connected to the camera.
2. Press and hold the **default** button for about 8 seconds.

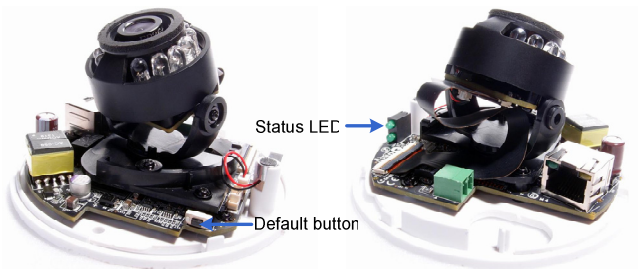

Figure 22-15

3. Release the **default** button when the **status LED** blinks.
4. When the **status LED** fades, the process of loading default settings is completed and the camera reboots automatically.

### Bullet Camera

1. Keep the power and network cables connected to the camera.
2. Loosen the camera's cover and remove the **Silica Gel Bag**.
3. Press and hold the **default** button for 8 seconds.

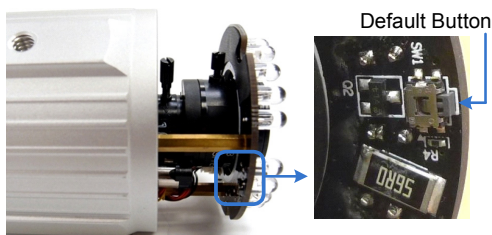

Figure 22-16

4. Release the **default** button. When the process of loading default settings is completed, the camera reboots automatically.
5. Insert a new **Silica Gel Bag** and fasten the camera's cover immediately.

### Ultra Bullet Camera

1. Keep the power and network cables (or PoE) connected to the camera.

2. Press and hold the **default** button.

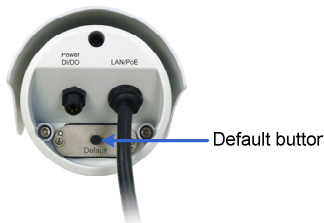

Figure 22-17

3. Release the **default** button when the **status LED** blinks. This shall take about 8 seconds.
4. When the **status LED** fades, the process of loading default settings is completed and the camera reboots automatically.

### Target Bullet Camera

1. Keep the power and network cables (or PoE) connected to the camera.
2. Loosen the camera's cover.
3. Press and hold the **default** button for about 8 seconds.

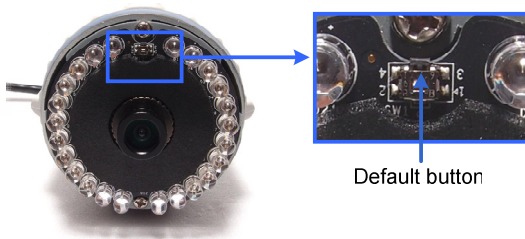

Figure 22-18

4. Release the **default** button. When the process of loading default settings is completed, the camera reboots automatically.
5. Replace the **Silica Gel Tape** inside the camera cover and fasten the camera's cover immediately.

## PTZ Camera

There are two types of default settings: **camera default settings** and **system default settings**. Camera default settings include all settings on Iris, White Balance, Image Reverse and Other in the VISCA OSD Configuration dialog box (Figure 11-19). System default settings refer to all the settings except the camera settings.

- **To load camera default settings:**

1. On the left menu of Web interface, select **Digital I/O and PTZ**, select **PTZ Settings**, and select **System Configure**. The VISCA OSD Configure dialog box appears.
2. Click the **Load Camera Default** button.

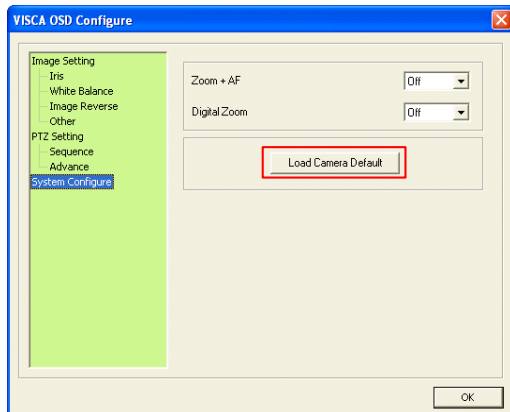

Figure 22-19

- **To load system default settings:**

1. Unplug the power cable and the network cable (or the PoE cable).
2. Press and hold the **default** button (No. 10, Figure 11-1).
3. Power on the camera using the power cable or the PoE cable.
4. Hold the **default** button until the two network LEDs fade. This will take about 25 seconds.

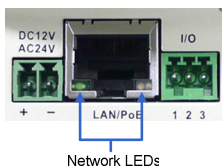

Figure 22-20

5. When default loading is completed, the camera will pan and tilt to its full range and return to the home point.

### PT Camera

1. Keep the power and network cables connected to the camera.
2. Use a pin to press and hold the **default** button on the panel.



Figure 22-21

3. Release the **default** button when the **status LED** blinks. This shall take about 8 seconds.
4. When the **status LED** turns orange, the process of loading default settings is completed and the camera is ready for use.

### Vandal Proof IP Dome

1. Keep the power and network cables (or PoE) connected to the camera.
2. Use a pin to press and hold the **default** button on the inner housing.



Figure 22-22

3. Release the **default** button when the **status LED** blinks. This shall take about 8 seconds.
4. When the **status LED** fades, the process of loading default settings is completed and the camera reboots automatically.

### Fixed IP Dome

1. Keep the power and network cables (or PoE) connected to the camera.
2. Use a pin to press and hold the **default** button on the panel.



Figure 22-23

3. Release the **default** button when the **status LED** blinks. This shall take about 8 seconds.
4. When the **status LED** fades, the process of loading default settings is completed and the camera reboots automatically.



### Cube Camera

1. Keep the power and network cables connected to the camera.
2. Use a pin to press and hold the **default** button on the panel.

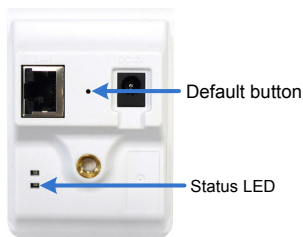
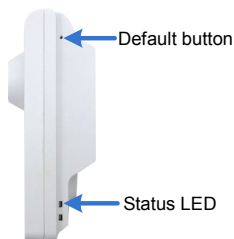

*Figure 22-24*

3. Release the **default** button when the **status LED** blinks. This shall take about 8 seconds.
4. When the **status LED** turns orange, the process of loading default settings is completed and the camera is ready for use.

### Advanced Cube Camera

1. Keep the power and network cables connected to the camera.
2. Use a pin to press and hold the **default** button on the panel.



*Figure 22-25*

3. Release the **default** button when the **status LED** blinks. This shall take about 8 seconds.
4. When the **status LED** turns green, the process of loading default settings is completed and the camera is ready for use.

## 22.4 Verifying Watermark

The watermark is an encrypted and digital signature embedded in the video stream during the compression stage, protecting the video from the moment of creation. Watermarking ensures that an image is not edited or damaged after it is recorded. To enable the watermark function, see [Watermark Setting], 20.1.1 *Video Settings*.

The **Watermark Proof** is a watermark-checking program. It can verify the authenticity of the recording before you present it in court.

### 22.4.1 Accessing AVI Files

To verify watermark, first you have to access the recorded AVI files by one of these methods:

1. Use the **File Save** function (No.6, Figure 19-3) to start recording on the local computer.
2. Use the **Act as FTP Server** function to download AVI files from the GV-IPCAM H.264. See 20.3.2 *FTP*.
3. Use the files recorded on the memory card. Since the files saved on the memory card are of Linux file system, remember to run **Ext2Fsd program** for Windows-based system to read and access Linux-based files. For the instructions, see 21.2.1 *Playback from the Memory Card*.

## 22.4.2 Running Watermark Proof

1. Install **Watermark Proof** from the Software CD. After installation, a **WMPProof** icon is created on your desktop.
2. Double-click the created icon. The Water Mark Proof window appears.
3. Click **File** from the menu bar, select **Open** and locate the recording (.avi). The selected recording is then listed on the window. Alternatively, you can drag the recording directly from the storage folder to the window.
4. If the recording is unmodified, a check mark will appear in the **Pass** column. On the contrary, if the recording is modified or does not contain watermark during recording, a check mark would appear in the **Failed** column. To review the recording, double-click the listed file on the window.

## 22.4.3 The Watermark Proof Window

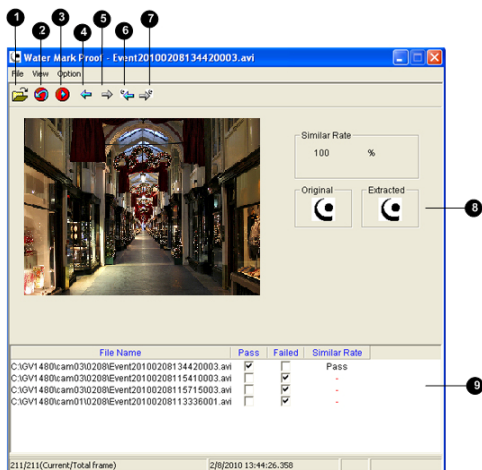

Figure 22-26

The controls in the window:

No.	Name	Description
1	Open File	Opens the recording.
2	First Frame	Goes to the first frame of the file.
3	Play	Plays the file.
4	Previous Frame	Goes to the previous frame of the file.
5	Next Frame	Goes to the next frame of the file.
6	Previous Watermarked Frame	Goes to the previous frame that contains watermark.
7	Next Watermarked Frame	Goes to the next frame that contains watermark.
8	Original vs. Extracted	The Extracted icon should be identical with the Original icon. If not, it indicates the recording has been tampered.
9	File List	Displays the proof results.

## 22.5 Downloading Videos from the Micro SD Card

When connections of GV-IP Cameras to the GV-System are lost, recordings are automatically saved to the memory cards inserted in the GV-IP Cameras. To automatically synchronize and download recordings from the micro SD cards to a local folder, install and execute the **GV-SDCardSync Utility** program.

---

**Note:** GV-SDSyncCard Utility is only supported in GV-System V8.5.4 or later and in GV-IPCam H.264 V1.11 or later.

---

## 22.5.1 Installing the GV-SDCardSync Utility

1. Download the **GV-SD Card Sync Utility** program from [http://ftp.geovision.tw/FTP/neo/Utility/GvSDCardSync\\_Setup.zip](http://ftp.geovision.tw/FTP/neo/Utility/GvSDCardSync_Setup.zip)

---

**Note:** The GV-SD Card Sync Utility must be installed on the computer installed with GV-System V8.5.4 or later.

---

2. Execute the **GV-SDCard Sync Utility** program. The main window and the Setting window appear. The Setting window pops up automatically upon first execution. Otherwise, click the **Setting** button .

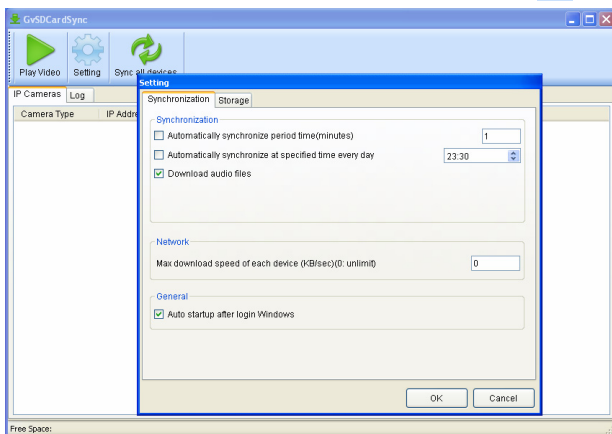

Figure 22-27

3. To configure synchronization, network and startup settings, see the steps below.

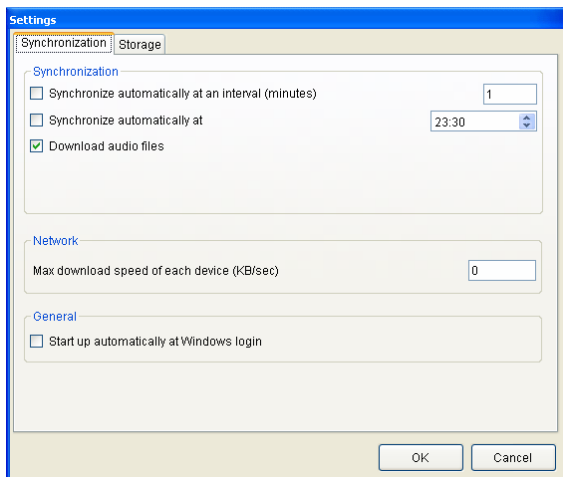

Figure 22-28

### [Synchronization]

- **Synchronize automatically at an interval:** Automatically synchronize videos from micro SD cards to a local folder at the specified interval.
- **Synchronize automatically at:** Automatically synchronize videos from micro SD cards to a local folder at the specified time.
- **Download Audio Files:** You may choose to download audio files along with the video files. This option is enabled by default.



**[Network]**

- **Max. download speed of each device (Kb/sec):** To make sure the bandwidth is not completely taken up while downloading files from the memory card, specify a maximum download speed. If you do not want to set a bandwidth limit, type **0**.

**[General]**

- **Start up automatically at Windows login:** GV-SDSync Utility launches automatically when Windows starts up.
4. By default, downloads are saved to **:\GvSDCardSync** and are not recycled automatically. To configure the storage and recycling settings, select the **Storage** tab on the Setting window. This page appears.

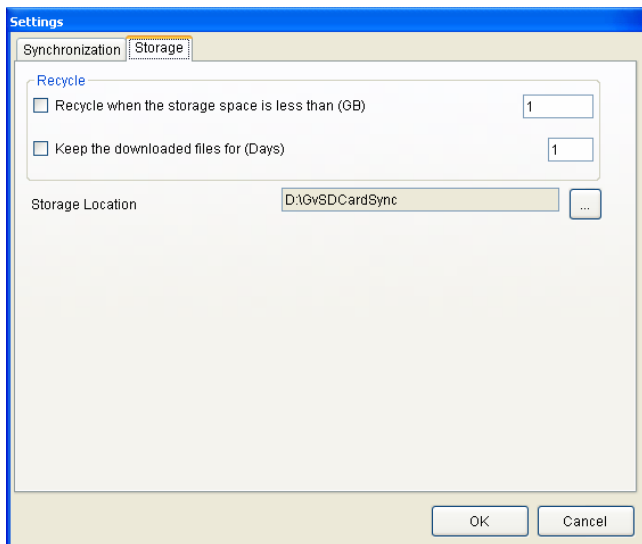

*Figure 22-29*

**[Recycle]**

- **Recycle when the storage space is less than (GB):** Specify a minimum free space of your local storage for file recycling.
- **Keep the downloaded files for (Days):** Specify the number of days to keep the download files at the local hard drive.

**[Storage Location]**

To configure the storage path, click the button next to the location field and specify a storage location.

5. Click **OK** to save the configuration or exit the Setting window.

---

**Note:** Keep the GV-SDCardSync Utility running in the background to automatically synchronize and download videos.

---

## 22.5.2 The GV-SDCardSync Utility Window

After you have installed the GV-SDCardSync Utility, point to **Start**, select **Programs**, select **GV-SDCardSync** and select  **GvSDCardSync** to launch the program. This window appears.

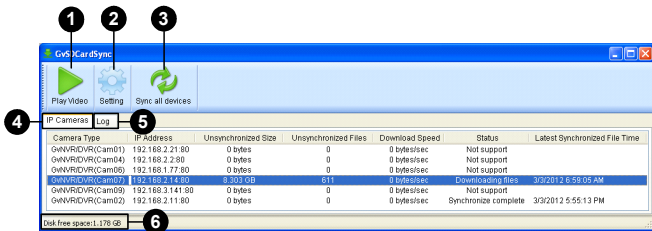

Figure 22-30

No.	Name	Description
1	Play Video	Plays downloaded recordings of the selected GV-IP Cameras using the ViewLog player. For details, see Chapter 4, <i>DVR User's Manual</i> on Surveillance System Software DVD.
2	Setting	Contains settings on synchronization, network, storage location and recycling criteria. See step 4 in <i>22.5.1 Installing the GV-SDCardSync Utility</i> .
3	Sync all devices	Manually synchronizes and downloads the recording files stored at GV-IP Cameras.
4	IP Camera Tab	Shows information of GV-IP Cameras connected to the GV-System, including channel number, IP address, size and number of unsynchronized files, download speed, status and the last synchronization time.

No.	Name	Description
5	Log Tab	Displays up to 100 event entries of the GV-SDCardSync Utility. Once the entries are full, recycling will start from the oldest file.
6	Storage Space	Shows the storage space of the designated hard drive.

**Note:**

1. The synchronization time is recorded according to the system time of the GV-IP Camera.
2. The logs are deleted once the GV-SDCardSync Utility is re-activated.

## Chapter 23 DVR Configurations

The GV-System provides hybrid solution, integrating the digital videos from IP cameras with other analog videos. For the digital videos, the GV-System provides the complete video management, such as video viewing, recording, playback, alert settings and almost every feature of the system. Following is the integration specifications:

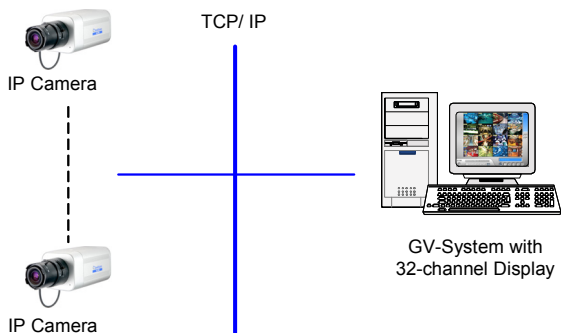

Figure 23-1

- The compatible version of GV-System for each camera model:

Camera	Models	Compatible version of GV-System	
Box Camera	GV-BX120D GV-BX220D Series GV-BX320D Series	V8.4 or later	
	GV-BX130D Series GV-BX140DW GV-BX520D	V8.5 or later	
	GV-BX1200-0F ~ 2F GV-BX1200-3V GV-BX1300-0F ~ 2F GV-BX1300-3V GV-BX2400-0F ~ 2F GV-BX2400-3V ~ 4V GV-BX3400-0F ~ 2F GV-BX3400-4V ~ 5V GV-BX5300-6V	V8.5.5 or later	
	GV-BX1500-0F ~ 2F GV-BX1500-3V	V8.5.7 or later	
	GV-BX1500-8F GV-BX2400-8F GV-BX3400-8F GV-BX5300-8F	V8.5.8 or later	
	GV-BX2500 Series	V8.5.9 or later	
	Ultra Box Camera	GV-UBX1301 Series GV-UBX2301 Series GV-UBX3301 Series	V8.5.6 or later
	Target Box Camera	GV-EBX1100-0F ~ 1F	V8.5.9 or later

Camera	Models	Compatible version of GV-System
IR Arctic Camera	GV-BX120D-E GV-BX220D-E GV-BX320D-E GV-BX520D-E	V8.4 or later
	GV-BX1500-E	V8.5.8 or later
	GV-BX2400-E GV-BX3400-E GV-BX5300-E	V8.5.7 or later
Mini Fixed Dome	GV-MFD120 GV-MFD130 GV-MFD220 GV-MFD320 GV-MFD520	V8.5 or later
	GV-MFD1501 Series	V8.5.7 or later
	GV-MFD2401 Series GV-MFD3401 Series GV-MFD5301 Series	V8.5.8 or later
	GV-MFD2501 Series	V8.5.9 or later
Mini Fixed Rugged Dome	GV-MDR120 GV-MDR220 GV-MDR320 GV-MDR520	V8.5 or later
	GV-MDR1500 Series GV-MDR2400 Series GV-MDR2500 Series GV-MDR3400 Series GV-MDR5300 Series	V8.5.9 or later
Target Mini Fixed Dome	GV-EFD1100-0F ~ 1F	V8.5.9 or later

Camera	Models	Compatible version of GV-System	
Bullet Camera	GV-BL120D GV-BL220D GV-BL320D	V8.4 (with patch files) or later	
	GV-BL130D	V8.5 or later	
	GV-BL1200 GV-BL1300 GV-BL2400 GV-BL3400 GV-BL1210 GV-BL2410 GV-BL3410 GV-BL5310	V8.5.6 or later	
	GV-BL1500	V8.5.7 (with patch files) or later	
	GV-BL1510	V8.5.8	
	GV-BL2500 GV-BL2510	V8.5.9 or later	
	Ultra Bullet Camera	GV-UBL1211 GV-UBL2411 GV-UBL3411 GV-UBL1301 Series GV-UBL2401 Series GV-UBL3401 Series	V8.5.6 or later
		GV-UBL1511	V8.5.8 or later
GV-UBL2511		V8.5.9 or later	
Target Bullet Camera	GV-EBL1100-0F ~ 1F	V8.5.9 or later	



Camera	Models	Compatible version of GV-System
PTZ Camera	GV-PTZ010D	V8.4 or later
PT Camera	GV-PT130D GV-PT220D GV-PT320D	V8.5.7 or later
Vandal Proof IP Dome	GV-VD120D Series GV-VD220D Series GV-VD320D Series	V8.4 (with patch files) or later
	GV-VD1500	V8.5.8 or later
	GV-VD2400 GV-VD3400	V8.5.6 or later
	GV-VD1530/1540 GV-VD2430/2440 GV-VD2500/2530/2540 GV-VD2540-E GV-VD3430/3440 GV-VD5340 GV-VD5340-E	V8.5.9 or later
	GV-FD120D GV-FD220D GV-FD320D	V8.4.3 (with patch files) or later
Fixed IP Dome	GV-FD1200 GV-FD2400 GV-FD3400 GV-FD5300	V8.5.7 or later

Camera	Models	Compatible version of GV-System
Fixed IP Dome	GV-FD1210 GV-FD2410 GV-FD3410	V8.5.7 or later
	GV-FD1500 GV-FD1510	V8.5.8 or later
	GV-FD2500 GV-FD2510	V8.5.9 or later
Cube Camera	GV-CB120 GV-CB220	V8.4.3 (with patch files) or later
	GV-CBW120 GV-CBW220	V8.5 or later
Advanced Cube Camera	GV-CA120 GV-CA220 GV-CAW120 GV-CAW220	V8.5.5 or later

- The maximum number of streams which the GV-IPCAM H.264 allows varies according to its resolution:

Camera Models	Max. No. of Streams
GV-PTZ010D	3
1.3 M models except GV-PTZ010D	8
2 M models	6
3 M models	
5 M models	

- When a GV-IPCAM H.264 is connected to IE browser or any other applications, it takes up 1 stream; when a GV-IPCAM H.264 is connected to GV-System, it takes up 2 streams.

---

**Note:**

1. The above maximum numbers of streams are based on the maximum resolution for each camera and the codec H.264.
  2. By default, GV-IPCAM H.264 is in dual streams and will take up 2 streams when connected to GV-System.
- 

- The hardware compression and the “Pre-Recording Using RAM” feature cannot work on the videos from GV-IPCAM H.264.

## 23.1 Setting up an IP Camera

To set up the GV-IPCAM H.264 on the GV-System, follow these steps:

1. On the main screen, click the **Configure** button, select **System Configure**, select **Camera Install** and click **IP Camera Install**. This dialog box appears.

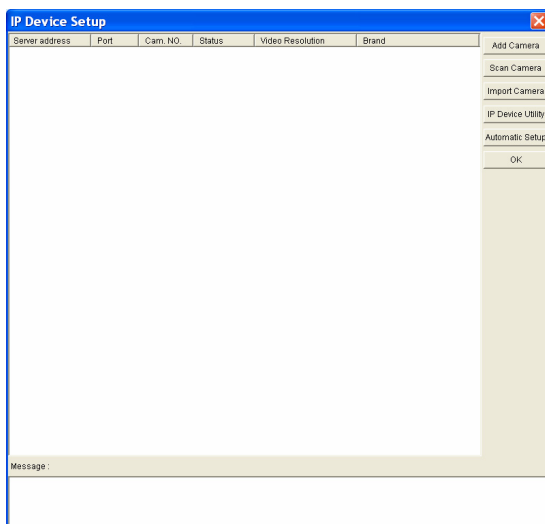

Figure 23-2

- To add an IP camera from a list of the IP cameras on the LAN, click **Scan Camera**.
- To manually set up an IP camera, follow steps 2 to 7

2. Click **Add Camera**. The dialog box appears.



*Figure 23-3*

3. Type the IP address, username and password of the IP camera. Select the camera brand and device from the drop-down lists. This dialog box appears.

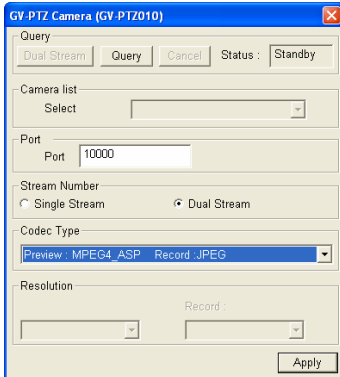

*Figure 23-4*

4. The GV-System will automatically query for the IP camera, and the status will be indicated as "Standby". If not, modify the HTTP port (Figure 23-3) and streaming port (Figure 23-4) to match those of the IP camera, and click the **Query** button to detect the IP camera again.

5. The options in the setup dialog box may vary depending on the camera model.
  - **Dual Stream:** Click this button to set the codec type to H.264 in the main stream and to MJPEG in the sub stream, and each stream with a different resolution. For details on supported versions and resolutions in different cameras, see *Appendix G*.
  - **Port:** Video streaming port number.
  - **Stream Number:** You have the option of single streaming only or both single and dual streaming.
  - **Codec type:** You have the options of JPEG and H.264. If the selected camera supports dual streaming, the preview codec and recording codec can be set differently.
  - **Resolution:** Select resolutions for preview and recording.
6. Click **Apply**. The IP camera is added to the list.
7. Click the listed camera, and select **Display position** to map the IP camera to a channel on the GV-System.

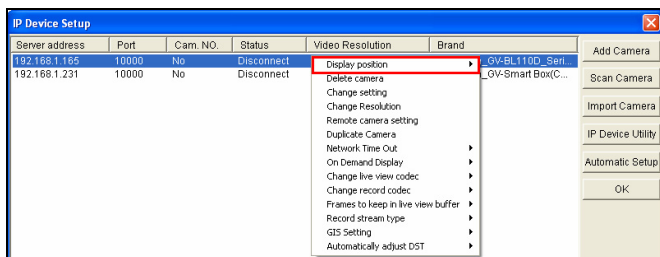

Figure 23-5

8. The Status column now should display **“Connected”**. Click **OK**.

## 23.1.1 Customizing IP Camera Settings

After the IP camera is connected and assigned with a display position, you can configure the camera's settings such as frame rate, codec type and resolution. Right-click the desired camera to see the following list of options:

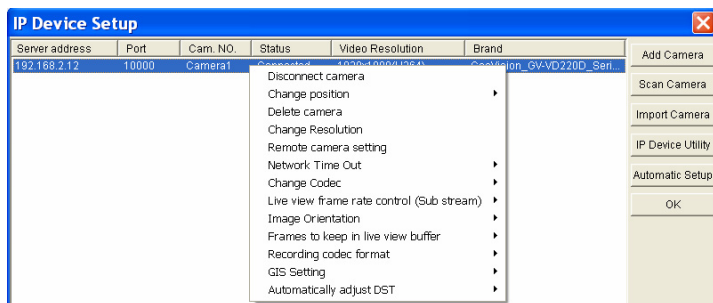

Figure 23-6

- **Change Resolution:** Changes the display ratio, live view resolution and record resolution
- **Network Time Out:** When network disconnection exceeds the specified time period, the camera status will be displayed as Connection Lost.
- **Change Live View Codec:** Changes the live view codec.
- **Change Record Codec:** Changes the recording codec.
- **Live-view frame rate control (Sub stream):** Sets the live view frame rate of the sub stream to help reduce the CPU usage. If you have set the live view codec to be **JPEG**, select the number of frames to allow in a second. If you chose the **H.264** codec, select one of the following options:
  - ⊙ **Maximum Live-view Frame Rate:** View the video at the maximum frame rate possible.

- ⊙ **Live-view Key Frame only:** You can choose to view the key frames of the videos only instead of all frames on the live view. This option is related to the GOP setting of the IP camera. For example, if the GOP value is set to 30, there is only one key frame among 30 frames.
- **Live-view frame rate control (Main stream):** Sets the live view frame rate of the main stream with higher resolution when On Demand function is enabled. Refer to Live-view frame rate control above to see the options available.
- **Image Orientation:** You can adjust the image orientation by selecting **Normal, Horizontal Mirror, Vertical Flip** or **Rotate 180**.
- **Frames to keep in live view buffer:** Specifies the number of frames to keep in the live view buffer.
- **Recording Codec Format:** Specifies whether to record in standard or GeoVision type of JPEG or H.264 codec.
- **GIS Setting:** Records the video with the GPS data. To record the GPS data, remember to also enable the GIS function of the GV-System (Configure button < Accessories < Enable Local GIS).
- **Automatically Adjust DST:** If enabled, the time on the GV-IP device Web interface will be synchronized with the time of the GV-System when DST period starts or ends on the GV-System.



## 23.2 Remote Monitoring with Multi View

You can use the Multi View to monitor and manage the GV-IPCAM H.264.

### 23.2.1 Connecting to the IP Camera

1. On the Multi View window, click the **Edit Host** button. The Edit Host window appears.
2. To create a host, click the **New** button. You need to create a group before creating a host.
3. Select **GV-IP Camera, GV-IP Speed Dome** from the Device drop-down list. Type the host name, IP address, user name and password of the camera. Modify the default VSS port **10000** if necessary.

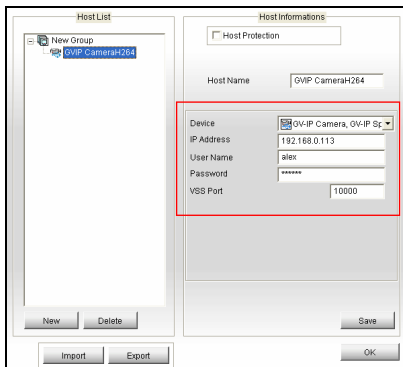

Figure 23-7

4. Click **Save** to establish connection.

For details on the Multi View functions, see “Multi View Viewer”, *Remote Viewing, DVR User’s Manual* on the Surveillance System Software DVD.

## 23.3 Remote Monitoring with E-Map

You can use the Remote E-Map to monitor and manage the GV-IPCAM H.264.

### 23.3.1 Creating an E-Map for the IP Camera

With the E-Map Editor, you can create an E-Map for the GV-IPCAM H.264. The E-Map Editor is available in the two applications: Main System and E-Map Server. The following is an example of running the E-Map Editor included in the Main System.

1. Go to Windows **Start** menu, point to **Programs**, select **GV folder** and click **E-Map Editor**.
2. To create an E-Map, click the **Add Map** button on the toolbar. A New Map file appears.
3. Double-click the New Map file, and click the **Load Map** button on the toolbar to import a graphic file
4. To create a host, click the **Add Host** button on the toolbar and select **Add IPCam**.
5. Right-click the created New Host in the Host View, and select **Host Settings**. This dialog box appears.

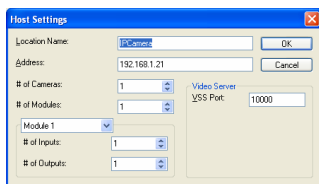

Figure 23-8

6. Give the camera a location name, and type its IP address (or domain name). Modify the default VSS port **10000** if necessary.

7. Click **OK** to save the settings.
8. Expand the created host folder. Drag and drop the icons of camera and I/O devices onto the imported E-Map.
9. Close the E-Map Editor. Click **Yes** when you are promoted to save the file.

For details on creating an E-Map file on the E-Map Server, see “E-Map Server”, *E-Map Application, DVR User’s Manual* on the Surveillance System Software DVD.

### 23.3.2 Connecting to the IP Camera

Depending on where you save the created E-Map file (DVR, E-Map Server or Control Center), the steps to open the Remote E-Map window for monitoring may vary slightly. The following is the connection example when you store the E-Map file on the DVR.

1. To enable the remote access to the DVR, click the **Network** button, select **WebCam Server** to display the Server Setup dialog box, and click **OK** to start the WebCam Server.
2. At the local computer, open the web browser and type the address of the DVR. The Single View page appears.
3. Select **Emap**. A valid user name and password are required for login. For the first-time user, you will be directed to the Download page. Install the E-Map program before you can run it.
4. On the Remote E-Map window, click the **Login** button and select the camera host to access its videos and I/O devices. A valid user name and password are required to log in the camera.

For details on the Remote E-Map functions, see “The Remote E-Map Window”, *E-Map Application, DVR User’s Manual* on the Surveillance System Software DVD.

## Chapter 24 CMS Configurations

This section introduces the related settings to enable connecting to the GV-IPCAM H.264 in the central monitoring stations Center V2, VSM and Dispatch Server.

### 24.1 Center V2

The Center V2 can monitor and manage the camera and I/O devices connected to the GV-IPCAM H.264.

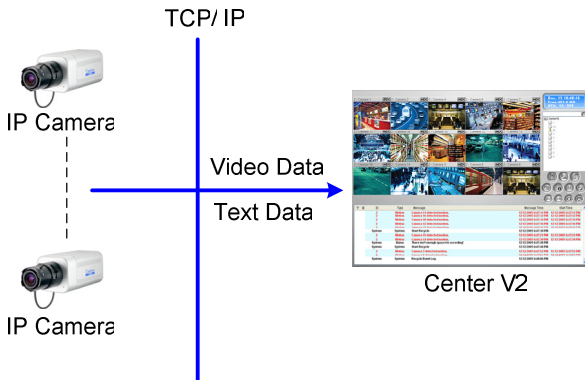

Figure 24-1

- To set the appropriate port for IP camera connection, click the **Preference Settings** button, select **System Configure**, click the **Network** tab, and select **Accept connections from GV-Compact DVR, Video Server & IP Cam**. Keep default port **5551**, or modify it to match the Center V2 port on the IP camera.

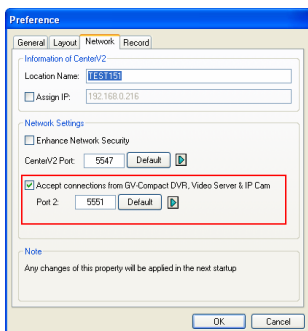

Figure 24-2

- To define how to display the received video on motion detection and input trigger from the IP camera, click the **Preference Settings** button and select **System Configure**. This dialog box appears.

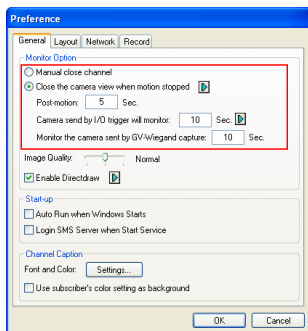

Figure 24-3

- **Manual close channel:** Closes the triggered camera view manually.
- **Close the camera view when motion stopped:** Closes the triggered camera view automatically when motion stops.
- **Post Motion:** Specify the duration of the camera view remaining on the monitoring window after a motion stops.
- **Camera send by I/O trigger will monitor:** Specify the duration of the camera view remaining on the monitoring window when an I/O device is triggered.

To keep the camera view remaining on the monitoring window even after the alarm is finished, click the right-arrow button, and uncheck **Latch Trigger**. Then the camera view will remain on the monitoring window for the specified time. For example, if the alarm is triggered for 5 minutes and you set 10 minutes, the camera view will be displayed for 15 minutes.

For further information on how to manage the video received from the IP camera, see *GV-CMS Series User's Manual*.

## 24.2 VSM

The VSM is designed to monitor and manage the camera and I/O devices connected to the GV-IPCAM H.264 under low bandwidth network.

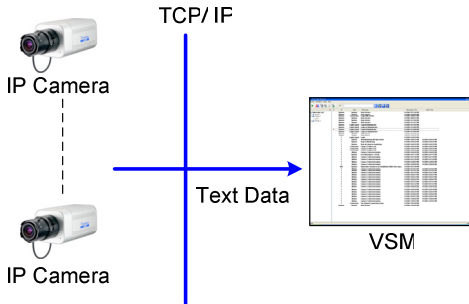

Figure 24-4

- To set the appropriate port connecting to the IP camera, click **Configure** on the window menu, and select **System Configure** to display this dialog box. In the Connective Port field, keep the default port **5609**, or modify it to match the VSM port on the IP camera.

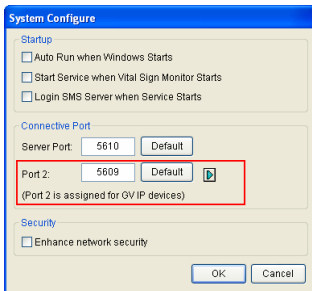

Figure 24-5

For further information on how to manage the video received from the IP camera, see *GV-CMS Series User's Manual*.



## 24.3 Dispatch Server

The Dispatch Server minimizes overloading of Center V2 Servers by re-distributing GV-IPCAM H.264 subscribers to the least busy Center V2 Server.

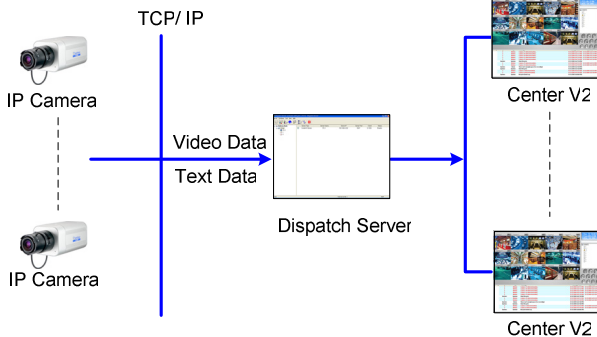

*Figure 24-6*

- To set the appropriate port connecting to the IP camera, click the **Server Setting** button on the toolbar, and select **Allow GV IP devices to login as subscriber from port**. Keep the default port as **5551**, or modify it to match the Center V2 port on the IP camera.

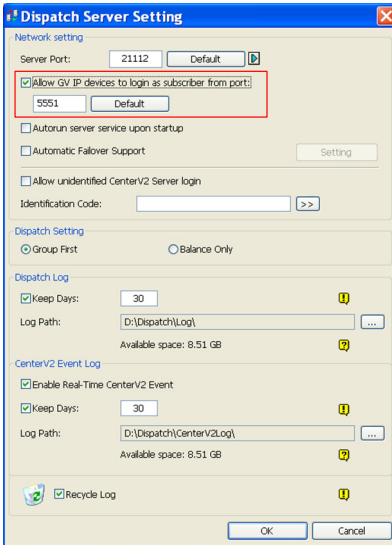

Figure 24-7

For further information on how to manage the video received from the IP camera, see *GV-CMS Series User's Manual*.

## Chapter 25 Smart Device Connection

You can access the live view and play back recordings on your mobile devices using the following GV-Mobile applications:

1. GV-Eye for Android Smartphone and Tablet
2. GV-Eye HD for iPad
3. GV-Eye for iPhone and iPod Touch

For details on system requirements, installation and setup, visit our website:

[http://www.geovision.com.tw/english/5\\_4\\_iview.asp](http://www.geovision.com.tw/english/5_4_iview.asp)

---

**Note:** To receive the live video from the camera, enter the TCP/IP port on your mobile phone. To play video back, enable **ViewLog Server** on the camera and enter the RPB Port on your mobile phone.

---

## Appendix

### A. Settings for Internet Explorer 8

If you use Internet Explorer 8, it is required to complete the following setting.

1. Set the Security to **Medium-high (default)**.
2. Enable **Allow previously unused ActiveX controls to run without prompt**.
3. Disable **Only allow approved domains to use ActiveX without prompt**.

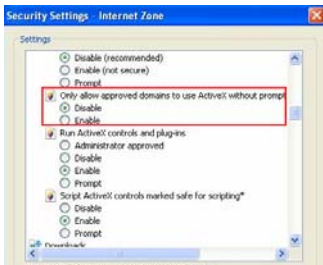
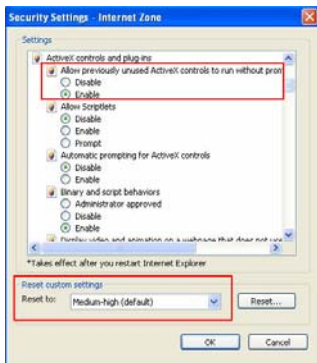

## B. Supported Lenses for Box Camera

Provider	Model No.
Fujian Forecam Optics	RV0409D.IR
	RV0515D.IR
	RV0820D.IR
EVETAR	EVD03618F-IR
	EVD04218F-IR
	EVD06018F-IR
	EVD08018F-IR
	EVD12018F-IR
	EVD16018F-IR
Pentax	TS3VP213ED-M

## C. Resolution and Frame Rate

Note that the frame rate and the performance may vary depending on the number of connections and data bitrates (different scenes).

GV-IP Camera	Stream	Ratio	Resolution	Max. Frame Rate	
GV-BL120D	Main	4:3	1280 x 960	30 fps	
GV-BL130D		16:9	1280 x 720		
GV-BL1200		5:4	1280 x 1024		
GV-BL1300	Sub	4:3	640 x 480		
GV-BL1210			320 x 240		
GV-BL1500			16:9		640 x 360
GV-BL1510		448 x 252			
GV-BX120D		5:4			640 x 512
GV-BX130D Series					320 x 256
GV-BX1200 Series					GV-PT130D
GV-BX1300 Series					
GV-BX1500 Series					
GV-BX120D-E					
GV-BX1500-E					
GV-CA120					
GV-CAW120					
GV-CB120					
GV-CBW120					
GV-FD120D					
GV-FD1200					
GV-FD1210					
GV-FD1500					
GV-FD1510					
GV-MDR120					
GV-MDR1500 Series					
GV-MFD120					
GV-MFD130					
GV-MFD1501 Series					

GV-IP Camera	Stream	Ratio	Resolution	Max. Frame Rate		
<b>GV-UBL1301 Series</b> <b>GV-UBL1511</b> <b>GV-UBX1301 Series</b> <b>GV-VD120D</b> <b>GV-VD121D</b> <b>GV-VD122D</b> <b>GV-VD123D</b> <b>GV-VD1500</b> <b>GV-VD1530</b> <b>GV-VD1540</b>	<b>Main</b>	4:3	1280 x 960	30 fps		
		16:9	1280 x 720			
		5:4	1280 x 1024			
	<b>Sub</b>	4:3	640 x 480 320 x 240			
		16:9	640 x 360 448 x 252			
		5:4	640 x 512 320 x 256			
	<b>GV-BX140DW</b>	<b>Main</b>	16:9		1280 x 720	30 fps
		<b>Sub</b>	16:9		640 x 360 448 x 252	
	<b>GV-EBL1100</b> <b>GV-EBX1100</b> <b>GV-EFD1100</b>	<b>Main</b>	4:3		1280 x 960 640 x 480 448 x 336	30 fps
16:9			1280 x 720 640 x 360 448 x 252			
5:4			1280 x 1024 640 x 512 448 x 360			
<b>Sub</b>		4:3	640 x 480 448 x 336			
		16:9	640 x 360 448 x 252			
		5:4	640 x 512 448 x 360			

GV-IP Camera	Stream	Ratio	Resolution	Max. Frame Rate
<b>GV-BL220D</b> <b>GV-BL2400</b> <b>GV-BL2410</b> <b>GV-BL2500</b> <b>GV-BL2510</b> <b>GV-BX220D Series</b> <b>GV-BX2400 Series</b> <b>GV-BX2500 Series</b> <b>GV-BX220D-E</b> <b>GV-BX2400-E</b> <b>GV-CA220</b> <b>GV-CAW220</b> <b>GV-CB220</b> <b>GV-CBW220</b> <b>GV-FD220D</b> <b>GV-FD2400</b> <b>GV-FD2410</b> <b>GV-FD2500</b>	<b>Main</b>	4:3	1600 x 1200 1280 x 960	30 fps
		16:9	1920 x 1080 1280 x 720	
		5:4	1280 x 1024	
	<b>Sub</b>	4:3	640 x 480 320 x 240	
		16:9	640 x 360 448 x 252	
		5:4	640 x 512 320 x 256	



GV-IP Camera	Stream	Ratio	Resolution	Max. Frame Rate
GV-FD2510 GV-MDR220 GV-MDR2400 Series GV-MDR2500 Series GV-MFD220 GV-MFD2401 Series GV-MFD2501 Series	Main	4:3	1600 x 1200 1280 x 960	30 fps
		16:9	1920 x 1080 1280 x 720	
		5:4	1280 x 1024	
GV-PT220D GV-UBL2411 GV-UBL2511 GV-UBL2401 Series GV-UBX2301 Series GV-VD220D GV-VD221D GV-VD222D GV-VD223D GV-VD2400 GV-VD2430 GV-VD2440 GV-VD2500 GV-VD2530 GV-VD2540 GV-VD2540-E	Sub	4:3	640 x 480 320 x 240	
		16:9	640 x 360 448 x 252	
		5:4	640 x 512 320 x 256	

GV-IP Camera	Stream	Ratio	Resolution	Max. Frame Rate	
<b>GV-BL320D</b> <b>GV-BL3400</b> <b>GV-BL3410</b> <b>GV-BX320D Series</b> <b>GV-BX3400 Series</b> <b>GV-BX320D-E</b> <b>GV-BX3400-E</b> <b>GV-FD320D</b> <b>GV-FD3400</b> <b>GV-FD3410*</b> <b>GV-MDR320</b> <b>GV-MDR3400 Series</b> <b>GV-MFD320</b> <b>GV-MFD3401 Series</b> <b>GV-PT320D</b> <b>GV-UBL3411</b> <b>GV-UBL3401 Series</b> <b>GV-UBX3301 Series</b> <b>GV-VD320D</b> <b>GV-VD321D</b> <b>GV-VD322D</b> <b>GV-VD323D</b> <b>GV-VD3400*</b> <b>GV-VD3430</b> <b>GV-VD3440</b>	<b>Main</b>	4:3	2048 x 1536	20 fps	
			1600 x 1200 1280 x 960		
		16:9	1920 x 1080 1280 x 720		
		5:4	1280 x 1024		30fps
		4:3	640 x 480 320 x 240		
		<b>Sub</b>	16:9		

GV-IP Camera	Stream	Ratio	Resolution		Max. Frame Rate
<b>GV-BL5310</b> <b>GV-BX520D</b> <b>GV-BX5300 Series</b> <b>GV-BX520D-E</b> <b>GV-BX5300-E</b> <b>GV-FD5300</b> <b>GV-MDR520</b> <b>GV-MDR5300 Series</b> <b>GV-MFD520</b> <b>GV-MFD5301 Series</b> <b>GV-VD5340</b> <b>GV-VD5340-E</b>	<b>Main</b>	4:3	2560 x 1920		10 fps
			2048 x 1536		20 fps
			1600 x 1200 1280 x 960		30 fps
		16:9	1920 x 1080 1280 x 720		
			5:4	1280 x 1024	
		<b>Sub</b>	4:3	640 x 480 320 x 240	
	16:9		640 x 360 448 x 252		
	5:4		640 x 512 320 x 256		
	<b>GV-PTZ010D</b>	<b>Main</b>	n/a	NTSC	704 x 480 704 x 240 352 x 240
PAL				704 x 576 704 x 288 352 x 288	25 fps
<b>Sub</b>		n/a	NTSC	704 x 480 704 x 240 352 x 240	30 fps
			PAL	704 x 576 704 x 288 352 x 288	25 fps

## D. Support Lists

- Support List for GV-Backup Center, GV-Video Gateway and GV-Recording Server

GV-IP Camera	Model	Supported Version
<b>Box Camera</b>	GV-BX120D GV-BX220D Series GV-BX320D Series	V1.03 or later
	GV-BX130D Series	V1.04 or later
	GV-BX520D	V1.05 or later
	GV-BX1200 Series GV-BX1300 Series GV-BX2400 Series GV-BX3400 Series GV-BX5300 Series	V1.15 or later
<b>IR Arctic Box Camera</b>	GV-BX120D-E GV-BX220D-E GV-BX320D-E GV-BX520D-E	V1.07 or later
<b>Mini Fixed Dome</b>	GV-MFD130	V1.04 or later
	GV-MFD120 GV-MFD220 GV-MFD320 GV-MFD520	V1.05 or later
<b>Mini Fixed Rugged Dome</b>	GV-MDR120 GV-MDR220 GV-MDR320 GV-MDR520	V1.07 or later

<b>GV-IP Camera</b>	<b>Model</b>	<b>Supported Version</b>
<b>Bullet Camera</b>	GV-BL120D GV-BL220D GV-BL320D	V1.03 or later
	GV-BL130D	V1.04 or later
<b>PTZ Camera</b>	GV-PTZ010D	V1.08 or later
<b>Vandal Proof IP Dome</b>	GV-VD120D Series	V1.03 or later
	GV-VD220D Series	
	GV-VD320D Series	
<b>Fixed IP Dome</b>	GV-FD120D GV-FD220D GV-FD320D	V1.03 or later
	GV-CB120 GV-CB220	V1.03 or later
		GV-CBW120 GV-CBW220
<b>Advanced Cube Camera</b>	GV-CA120 GV-CA220 GV-CAW120 GV-CAW220	V1.15 or later

- Support List for Transmit Audio

GV-IP Camera	Model	Supported Version
<b>Box Camera</b>	GV-BX120D GV-BX220D Series GV-BX320D Series	V1.05 or later
	GV-BX130D Series	V1.04 or later
	GV-BX520D	V1.05 or later
	GV-BX1200 Series GV-BX1300 Series GV-BX2400 Series GV-BX3400 Series GV-BX5300 Series	V1.15 or later
<b>IR Arctic Box Camera</b>	GV-BX120D-E GV-BX220D-E GV-BX320D-E GV-BX520D-E	V1.07 or later
<b>Mini Fixed Dome</b>	GV-MFD130	V1.04 or later
	GV-MFD120 GV-MFD220 GV-MFD320 GV-MFD520	V1.05 or later
<b>Mini Fixed Rugged Dome</b>	GV-MDR120 GV-MDR220 GV-MDR320 GV-MDR520	V1.07 or later

<b>GV-IP Camera</b>	<b>Model</b>	<b>Supported Version</b>
<b>Bullet Camera</b>	GV-BL120D GV-BL220D GV-BL320D	V1.05 or later
	GV-BL130D	V1.04 or later
<b>PTZ Camera</b>	GV-PTZ010D	V1.08 or later
<b>Vandal Proof IP Dome</b>	GV-VD120D Series	V1.05 or later
	GV-VD220D Series	
	GV-VD320D Series	
<b>Fixed IP Dome</b>	GV-FD120D GV-FD220D GV-FD320D	V1.05 or later
	GV-CB120 GV-CB220	V1.03 or later
	GV-CBW120 GV-CBW220	V1.07 or later
<b>Advanced Cube Camera</b>	GV-CA120 GV-CA220 GV-CAW120 GV-CAW220	V1.15 or later

- Support List for System Log

GV-IP Camera	Model	Supported Version
<b>Box Camera</b>	GV-BX120D GV-BX220D Series GV-BX320D Series	V1.11 or later
	GV-BX130D Series	
	GV-BX520D	V1.15 or later
	GV-BX1200 Series GV-BX1300 Series GV-BX2400 Series GV-BX3400 Series GV-BX5300 Series	
<b>IR Arctic Box Camera</b>	GV-BX120D-E GV-BX220D-E GV-BX320D-E GV-BX520D-E	V1.11 or later
<b>Mini Fixed Dome</b>	GV-MFD130 GV-MFD120 GV-MFD220 GV-MFD320 GV-MFD520	V1.11 or later
<b>Mini Fixed Rugged Dome</b>	GV-MDR120 GV-MDR220 GV-MDR320 GV-MDR520	V1.11 or later



<b>GV-IP Camera</b>	<b>Model</b>	<b>Supported Version</b>
<b>Bullet Camera</b>	GV-BL120D GV-BL130D GV-BL220D GV-BL320D	V1.11 or later
<b>PTZ Camera</b>	GV-PTZ010D	V1.08 or later
<b>Vandal Proof IP Dome</b>	GV-VD120D Series	V1.11 or later
	GV-VD220D Series	
	GV-VD320D Series	
<b>Fixed IP Dome</b>	GV-FD120D GV-FD220D GV-FD320D	V1.11 or later
<b>Cube Camera</b>	GV-CB120 GV-CB220 GV-CBW120 GV-CBW220	V1.11 or later
<b>Advanced Cube Camera</b>	GV-CA120 GV-CA220 GV-CAW120 GV-CAW220	V1.15 or later

## E. RTSP Protocol Command

The GV-IPCAM H.264 can support RTSP protocol for both audio and video streaming.

- If you use the QuickTime player, enter:

**rtsp://<IP of the GV-IPCAM H.264:8554/<CH No.>.sdp**

For example, rtsp://192.168.3.111:8554/CH001.sdp

- If you use the VLC, and if authentication is required, enter:

**rtsp://username:password@<IP of the GV-IPCAM H.264:8554/<CH No.>.sdp**

For example, rtsp://admin:admin@192.168.3.111:8554/CH001.sdp

- If you use the VLC, and if authentication is *not* required, enter:

**rtsp://@<IP of the GV-IPCAM H.264:8554/<CH No.>.sdp**

For example, rtsp://@192.168.3.111:8554/CH001.sdp

---

### Note:

1. The RTSP streaming is supported over HTTP, UTP and TCP port.
  2. The RTSP server must be enabled on the Web interface. See Figure 20-20.
  3. Only VLC and QuickTime players are supported for streaming video via RTSP protocol.
  4. For GV-PTZ010D, the RTSP streaming provides source video images of 352 x 240 / 352 x 288 only.
-

## F. The CGI Command

Please note the supported version of the CGI command in different models:

<b>GV-IP Camera</b>	<b>Supported Version</b>
<b>GV-PTZ010D</b>	V1.07 or later
<b>GV-BX120D</b> <b>GV-BX220D-2 / 223D-3</b> <b>GV-BX320D-0 / 320D-1</b>	V1.00 or later
<b>GV-BL120D / 220D / 320D</b> <b>GV-VD120D / 121D / 122D / 123D</b> <b>GV-VD220D / 221D / 222D / 223D</b> <b>GV-VD320D / 321D / 322D / 323D</b>	V1.02 or later
<b>GV-FD120D / 220D / 320D</b>	V1.03 or later
<b>GV-CB120 / 220</b>	V1.03 or later
<b>GV-BL130D</b> <b>GV-BX130D Series</b> <b>GV-MFD130</b>	V1.04 or later
<b>GV-BX520D</b> <b>GV-MFD120 / 220 / 320 / 520</b>	V1.05 or later
<b>GV-BX120D-E</b> <b>GV-BX220D-E</b> <b>GV-BX320D-E</b> <b>GV-BX520D-E</b> <b>GV-CBW120 / 220</b> <b>GV-MDR120 / 220 / 320 / 520</b>	V1.07 or later
<b>GV-BX140DW</b>	V1.10 or later

GV-IP Camera	Supported Version
<b>GV-BX1200 Series</b> <b>GV-BX1300 Series</b> <b>GV-BX2400 Series</b> <b>GV-BX3400 Series</b> <b>GV-BX5300 Series</b> <b>GV-CA120 / 220</b> <b>GV-CAW120 / 220</b>	V1.15 or later

You can use the CGI command to obtain a snapshot of the live view or access the User Account Web interface. For a GV-IPCAM H.264 with the following details:

IP address: 192.168.2.11

Username: admin

Password: admin

Desired stream: 1

- To obtain a snapshot of the live view, type the following into your web browser:

<http://192.168.2.11/PictureCatch.cgi?username=admin&password=admin&channel=1>

- To access the User Account Web interface, type the following into your web browser:

<http://192.168.2.11/ConfigPage.cgi?username=admin&password=admin&page=UserSetting>

## G. Dual Stream Support List

The table lists the firmware versions of GV-IP Cameras that support dual stream and the default resolutions after the camera is added to GV-System.

GV-IP Camera	Supported Firmware Version	Resolution	
		Main Stream (H.264)	Sub Stream (MJPEG)
<b>GV-BX120D</b>	V1.00 or later	1280 x 1024	320 x 256
<b>GV-BX1200 Series</b>	V1.15 or later		
<b>GV-MFD120</b>	V1.05 or later		
<b>GV-BX120D-E</b>	V1.07 or later		
<b>GV-CBW120</b>			
<b>GV-MDR120</b>			
<b>GV-BL120D</b>	V1.02 or later		
<b>GV-VD120D</b>			
<b>GV-VD121D</b>			
<b>GV-VD122D</b>			
<b>GV-VD123D</b>			
<b>GV-CB120</b>	V1.03 or later		
<b>GV-FD120D</b>			

GV-IP Camera	Supported Firmware Version	Resolution	
		Main Stream (H.264)	Sub Stream (MJPEG)
GV-BL130D GV-BX130D Series GV-MFD130	V1.04 or later	1280 x 1024	320 x 256
GV-BX1300 Series	V1.15 or later		
GV-BX140DW	V1.10 or later	1280 x 720	640 x 360
GV-BX220D Series	V1.00 or later	1920 x 1080	448 x 252
GV-BX2400 Series	V1.15 or later		
GV-MFD220	V1.05 or later		
GV-BX220D-E GV-CBW220 GV-MDR220	V1.07 or later		
GV-BL220D GV-VD220D GV-VD221D GV-VD222D GV-VD223D	V1.02 or later		
GV-CB220 GV-FD220D	V1.03 or later		
GV-CA220 GV-CAW220	V1.15 or later		

GV-IP Camera	Supported Firmware Version	Resolution	
		Main Stream (H.264)	Sub Stream (MJPEG)
<b>GV-BX320D Series</b>	V1.00 or later	2048 x 1536	320 x 240
<b>GV-BX3400 Series</b>	V1.15 or later		
<b>GV-MFD320</b>	V1.05 or later		
<b>GV-BX320D-E</b> <b>GV-MDR320</b>	V1.07 or later		
<b>GV-BL320D</b> <b>GV-VD320D</b> <b>GV-VD321D</b> <b>GV-VD322D</b> <b>GV-VD323D</b>	V1.02 or later		
<b>GV-FD320D</b>	V1.03 or later		
<b>GV-BX520D</b> <b>GV-MFD520</b>	V1.05 or later	2560 x 1920	320 x 240
<b>GV-BX5300 Series</b>	V1.15 or later		
<b>GV-BX520D-E</b> <b>GV-MDR520</b>	V1.07 or later		
<b>GV-PTZ010D-N</b>	V1.07 or later	704 x 480	352 x 240
<b>GV-PTZ010D-P</b>	V1.07 or later	704 x 576	325 x 288

## H. Power Supply Support List

The supported power type is indicated with a tick (✓) and the unsupported power type with a cross (✗).

GV-IP Camera		DC Power	AC Power	PoE
Box Camera		✓	✗	✓
Ultra Box Camera		✓	✗	✓
Target Box Camera		✓	✗	✓
IR Arctic Box Camera		✗	✗	✓
Mini Fixed Dome		✓	✗	✓
Mini Fixed Rugged Dome		✗	✗	✓
Target Mini Fixed Dome		✓	✗	✓
Bullet Camera		✓	✓	✓
Ultra Bullet Camera		✓	✗	✓
Target Bullet Camera		✓	✗	✓
PTZ Camera		✓	✓	✓
PT Camera		✓	✓	✓
Vandal Proof IP Dome		✓	✓	✓
Fixed IP Dome		✓	✓	✓
Cube Camera		✓	✗	✗
Advanced Cube Camera	GV-CA120/220	✓	✗	✓
	GV-CAW120/220	✓	✗	✗



## I. Supported Firmware for Flash Memory

The 128 MB flash memory is supported in **V1.09 or later** in all models of GV-IPCam H.264 Series except GV-PTZ010D.

To look up if the camera contains a 128 MB type flash memory, access the web interface or the GV IP Device Utility:

- **Web Interface**

Click **Management** and click **Tools**. The “128 MB” should be noted after the firmware version.

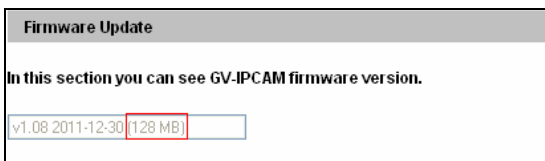

- **GV IP Device Utility**

The “128 M” should appear under the NOTE column.

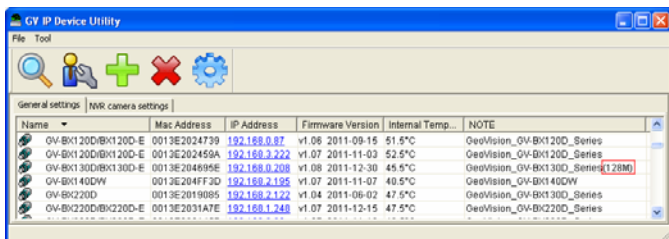

## Specifications: Box Camera (Part 1)

This section details the specifications on **GV-BX120D / 130D Series / 140DW / 220D Series / 320D Series / 520D**.

### Camera

Image Sensor	GV-BX120D	1/3" progressive scan low lux CMOS	
	GV-BX140DW	1/3" progressive scan CMOS	
	GV-BX130D Series GV-BX220D Series GV-BX320D Series GV-BX520D	1/2.5" progressive scan CMOS	
Picture Elements	GV-BX140DW	1280 (H) x 720 (V)	
	GV-BX120D GV-BX130D Series	1280 (H) x 1024 (V)	
	GV-BX220D Series	1920 (H) x 1080 (V)	
	GV-BX320D Series	2048 (H) x 1536 (V)	
	GV-BX520D	2560 (H) x 1920 (V)	
Minimum Illumination	GV-BX120D	Color	0.05 Lux
		B/W	0.03 Lux
		IR ON	0 Lux
	GV-BX130D-0 GV-BX130D-1	Color	0.15 Lux
		B/W	0.10 Lux
		IR On	0 Lux

<b>Minimum Illumination</b>	<b>GV-BX140DW</b>	<b>Color</b>	0.2 Lux
		<b>B/W</b>	0.08 Lux
		<b>IR On</b>	0 Lux
	<b>GV-BX220D Series GV-BX320D Series GV-BX520D</b>	<b>Color</b>	0.15 lux
		<b>B/W</b>	0.10 Lux
		<b>IR On</b>	0 Lux
<b>Shutter Speed</b>	<b>GV-BX140DW</b>	Automatic	
	<b>GV-BX120D GV-BX130D Series GV-BX220D Series GV-BX320D Series GV-BX520D</b>	Automatic, Manual (1/5 ~ 1/8000 sec)	
	<b>White Balance</b>		Automatic, Manual (2800K ~ 8500K)
	<b>Gain Control</b>		Automatic
	<b>S/N Ratio</b>	<b>GV-BX120D</b>	50 dB
<b>GV-BX130D Series</b>		45 dB	
<b>GV-BX140DW</b>		50 dB	
<b>GV-BX220D Series GV-BX320D Series GV-BX520D</b>		45 dB	
<b>WDR Pro</b>		<b>GV-BX140DW</b>	Yes (with WDR sensor)
<b>WDR</b>		Yes	

## Specifications: Box Camera (Part 1)

### Fixed Focal Lens (GV-BX130D-1 only)

<b>Megapixel</b>	Yes	
<b>Day/Night</b>	Yes (with removable IR-cut filter)	
<b>Focal Length</b>	4.0 mm	
<b>Maximum Aperture</b>	F/1.5	
<b>Mount</b>	CS	
<b>Image Format</b>	1/3"	
<b>Operation</b>	<b>Focus</b>	Manual
	<b>Zoom</b>	Fixed
	<b>Iris</b>	Fixed
<b>Max. Torque (Focus Screw)</b>	0.049 N.m	

### Varifocal Lens

<b>Megapixel</b>		Yes
<b>Day/Night</b>		Yes (with removable IR-cut filter)
<b>Focal Length</b>	GV-BX120D GV-BX130D-0 GV-BX140DW GV-BX220D-3	2.8 ~ 12 mm
	GV-BX320D-0	3.1 ~ 8 mm
	GV-BX220D-2 GV-BX320D-1	2.8 ~ 6 mm
	GV-BX520D	4.5 ~ 10 mm

<b>Maximum Aperture</b>	GV-BX120D GV-BX130D-0 GV-BX140DW GV-BX220D-3	F/1.4		
	GV-BX320D-0	F/1.2		
	GV-BX220D-2 GV-BX320D-1	F/1.3		
	GV-BX520D	F/1.6		
<b>Mount</b>		CS		
<b>Image Format</b>	GV-BX120D GV-BX130D-0 GV-BX140DW GV-BX220D-2 GV-BX220D-3 GV-BX320D-0 GV-BX320D-1	1/3"		
	GV-BX520D	1/2"		
<b>Operation</b>	<b>Focus</b>	Manual (w/lock)		
	<b>Zoom</b>	Manual (w/lock)		
	<b>Iris</b>	GV-BX120D GV-BX130D-0 GV-BX220D Series GV-BX320D Series	DC drive	
		GV-BX140DW	Fixed	
GV-BX520D		Manual (w/lock)		
<b>Max. Torque (Focus/ Zoom Screws)</b>		0.049 N.m		

## Specifications: Box Camera (Part 1)

### Operation

<b>Video Compression</b>		H.264, MJPEG
<b>Video Stream</b>		Dual streams from H.264 or MJPEG
<b>Frame Rate</b>	<b>GV-BX120D GV-BX130D Series</b>	30 fps at 1280 x 1024
	<b>GV-BX140DW</b>	30 fps at 1280 x 720
	<b>GV-BX220D Series</b>	30 fps at 1920 x 1080
	<b>GV-BX320D Series</b>	20 fps at 2048 x 1536 30 fps at 1920 x 1080
	<b>GV-BX520D</b>	10 fps at 2560 x 1920
<b>Image Setting</b>		Brightness, Contrast, Saturation, Sharpness, Gamma, White Balance, Flicker-less, Image Orientation, Shutter Speed, D/N Sensitivity, Backlight Compensation, WDR, Defog
<b>Audio Compression</b>		G.711, AAC (Optional)
<b>Audio Support</b>		Two-Way Audio
<b>Sensor Input</b>		1 input (Dry Contact)
<b>Alarm Output</b>		1 Digital Output (200mA 5V DC)
<b>Note:</b> <ol style="list-style-type: none"><li>1. The frame rate and performance may vary depending on the number of connections and data bitrates (different scenes).</li><li>2. GV-BX140DW does not support D/N sensitivity, backlight compensation, manual shutter speed, WDR and defog adjustment settings.</li></ol>		

## Video Resolution

<b>GV-BX120D</b> <b>GV-BX130D Series</b>	<b>Main Stream</b>	<b>4:3</b>	1280 x 960, 640 x 480, 320 x 240
		<b>16:9</b>	1280 x 720, 640 x 360, 448 x 252
		<b>5:4</b>	1280 x 1024, 640 x 512, 320 x 256
	<b>Stream Sub</b>	<b>4:3</b>	640 x 480, 320 x 240
		<b>16:9</b>	640 x 360, 448 x 252
		<b>5:4</b>	640 x 512, 320 x 256
<b>GV-BX140DW</b>	<b>Main Stream</b>	<b>16:9</b>	1280 x 720, 640 x 360, 448 x 252
	<b>Sub Stream</b>	<b>16:9</b>	640 x 360, 448 x 252
<b>GV-BX220D Series</b>	<b>Main Stream</b>	<b>4:3</b>	1600 x 1200, 1280 x 960, 640 x 480, 320 x 240
		<b>16:9</b>	1920 x 1080, 1280 x 720, 640 x 360, 448 x 252
		<b>5:4</b>	1280 x 1024, 640 x 512, 320 x 256
	<b>Sub Stream</b>	<b>4:3</b>	640 x 480, 320 x 240
		<b>16:9</b>	640 x 360, 448 x 252
		<b>5:4</b>	640 x 512, 320 x 256
<b>GV-BX320D Series</b>	<b>Main Stream</b>	<b>4:3</b>	2048 x 1536, 1600 x 1200, 1280 x 960, 640 x 480, 320 x 240
		<b>16:9</b>	1920 x 1080, 1280 x 720, 640 x 360, 448 x 252
		<b>5:4</b>	1280 x 1024, 640 x 512, 320 x 256
	<b>Sub Stream</b>	<b>4:3</b>	640 x 480, 320 x 240
		<b>16:9</b>	640 x 360, 448 x 252
		<b>5:4</b>	640 x 512, 320 x 256

## Specifications: Box Camera (Part 1)

GV-BX520D	Main Stream	4:3	2560 x 1920, 2048 x 1536, 1600 x 1200, 1280 x 960, 640 x 480, 320 x 240
		16:9	1920 x 1080, 1280 x 720, 640 x 360, 448 x 252
		5:4	1280 x 1024, 640 x 512, 320 x 256
	Sub Stream	4:3	640 x 480, 320 x 240
		16:9	640 x 360, 448 x 252
		5:4	640 x 512, 320 x 256

### Network

Interface	10/100 Ethernet
Protocol	DHCP, DynDNS, FTP, HTTP, HTTPS, NTP, ONVIF (Profile S), PSIA, QoS (DSCP), RTSP, SNMP, SMTP, TCP, UDP, UPnP, 3GPP/ISMA

### Mechanical

Temperature Detector		Yes
Connectors	Power	2-pin terminal block, PoE
	Ethernet	Ethernet (10/100 Base-T), RJ-45 cable
	Audio	1 In (Using the built-in microphone or externally connecting a microphone) 1 Out (Stereo phone jack, 3.5 mm / 0.14")



<b>Connectors</b>	<b>Auto Iris</b>	<b>GV-BX130D-1</b> <b>GV-BX140DW</b> <b>GV-BX520D</b>	Not functional
		<b>GV-BX120D</b> <b>GV-BX130D-0</b> <b>GV-BX220D Series</b> <b>GV-BX320D Series</b>	Yes
	<b>Local Storage</b>	Micro SD card slot (SD/SDHC, version 2.0 only, Class 10)	
	<b>TV-Out</b>	BNC connector (640 x 480 resolution)	
	<b>Digital I/O</b>	3-pin terminal block, pitch 2.5 mm / 0.1"	
<b>LED Indicator</b>		2 LEDs: Power, Status	
<p><b>Note:</b></p> <ol style="list-style-type: none"> <li>SDXC and UHS-I card types are not supported.</li> <li>The TV-Out function only works in 640 x 480 resolution. For TV-Out to work properly, you must set the video resolution to 1280 x 1024 or lower. If both streams are enabled, the Sub Stream must be set to 640 x 480.</li> </ol>			

## General

<b>Environment Temperature</b>	0°C ~ 50°C (32°F ~ 122°F)
<b>Humidity</b>	10% to 90% (no condensation)
<b>Power Source</b>	12V DC / PoE
<b>Max. Power Consumption</b>	7 W
<b>Dimensions (L X W X H)</b>	75.5 x 75 x 54 mm (2.97" x 2.95" x 2.13") (without lens)
<b>Weight</b>	321 g (0.71 lb)
<b>Regulatory</b>	CE, FCC, C-Tick, RoHS compliant

## Specifications: Box Camera (Part 1)

### Power over Ethernet

<b>PoE Standard</b>	IEEE 802.3af Power over Ethernet / PD
<b>PoE Power Supply Type</b>	End-Span
<b>PoE Power Output</b>	Per Port 48V DC, 350mA. Max. 15.4 watts
<b>Note:</b> An STP cable can only work with a one-port PoE adapter.	

### Web Interface

<b>Installation Management</b>	Web-based configuration
<b>Maintenance</b>	Firmware upgrade through Web Browser or Utility
<b>Access from Web Browser</b>	Camera live view, video recording, change video quality, bandwidth control, image snapshot, digital I/O control, audio, Picture in Picture, Picture and Picture, Privacy Mask, Visual Automation, Tampering Alarm, Text Overlay, Digital PTZ
<b>Language</b>	Arabic / Bulgarian / Czech / Danish / Dutch / English / Finnish / French / German / Greek / Hebrew / Hungarian / Indonesian / Italian / Japanese / Lithuanian / Norwegian / Persian / Polish / Portuguese / Romanian / Russian / Serbian / Simplified Chinese / Slovakian / Slovenian / Spanish / Swedish / Thai / Traditional Chinese / Turkish

## Application

<b>Network Storage</b>	GV-NVR, GV-System, GV-Backup Center, GV-Recording Server
<b>Smart Device Access</b>	GV-Eye for Android smartphone, tablet, iPhone, and iPod Touch; GV-Eye HD for iPad
<b>Live Viewing</b>	IE, mobile phone
<b>CMS Server support</b>	GV-Control Center, GV-Center V2, GV-VSM

All specifications are subject to change without notice

## Specifications: Box Camera (Part 2)

This section details the specifications on **GV-BX1200 Series / 1300 Series / 1500 Series / 2400 Series / 2500 Series / 3400 Series / 5300 Series**.

### Camera

Image Sensor	<b>GV-BX1200 Series</b>	1/3" progressive scan low lux CMOS	
	<b>GV-BX1500 Series</b>	1/3" progressive scan super low lux CMOS	
	<b>GV-BX2400 Series</b> <b>GV-BX3400 Series</b>	1/3.2" progressive scan CMOS	
	<b>GV-BX1300 Series</b> <b>GV-BX5300 Series</b>	1/2.5" progressive scan CMOS	
	<b>GV-BX2500 Series</b>	1/2.8" progressive scan super low lux CMOS	
Picture Elements	<b>GV-BX1200 Series</b> <b>GV-BX1300 Series</b> <b>GV-BX1500 Series</b>	1280 (H) x 1024 (V)	
	<b>GV-BX2400 Series</b> <b>GV-BX2500 Series</b>	1920 (H) x 1080 (V)	
	<b>GV-BX3400 Series</b>	2048 (H) x 1536 (V)	
	<b>GV-BX5300 Series</b>	2560 (H) x 1920 (V)	
Minimum Illumination	<b>GV-BX1200 Series</b>	<b>Color</b>	0.05 Lux
		<b>B/W</b>	0.03 Lux
		<b>IR ON</b>	0 Lux

<b>Minimum Illumination</b>	<b>GV-BX1300 Series</b> <b>GV-BX5300 Series</b>	<b>Color</b>	0.15 Lux
		<b>B/W</b>	0.10 Lux
		<b>IR ON</b>	0 Lux
	<b>GV-BX1500 Series</b>	<b>Color</b> <b>B/W</b>	0.01 Lux
		<b>IR ON</b>	0 Lux
		<b>GV-BX2500 Series</b>	<b>Color</b>
	<b>B/W</b>		0.02 Lux
	<b>IR On</b>		0 Lux
	<b>GV-BX2400 Series</b> <b>GV-BX3400 Series</b>	<b>Color</b>	0.08 Lux
		<b>B/W</b>	0.05 Lux
<b>IR On</b>		0 Lux	
<b>Shutter Speed</b>	Automatic, Manual (1/5 ~ 1/8000 sec)		
<b>White Balance</b>	Automatic, Manual (2800K ~ 8500K)		
<b>Gain Control</b>	Automatic		
<b>S/N Ratio</b>	<b>GV-BX1200 Series</b>	50 dB	
	<b>GV-BX1500 Series</b>	55 dB	
	<b>GV-BX1300 Series</b> <b>GV-BX5300 Series</b>	45 dB	
	<b>GV-BX2400 Series</b> <b>GV-BX3400 Series</b>	47 dB	
	<b>GV-BX2500 Series</b>	52 dB	
<b>WDR Pro</b>	<b>GV-BX2400 Series</b> <b>GV-BX3400 Series</b>	Yes (with WDR sensor)	
<b>WDR</b>	Yes		

## Specifications: Box Camera (Part 2)

### Fixed Focal Lens

(GV-BX1200-0F~2F / BX1300-0F~2F / BX1500-0F~2F / BX2400-0F~2F / BX2500-0F~2F / BX3400-0F~2F / BX1500-8F / BX2400-8F / BX2500-8F / BX3400-8F / BX5300-8F)

<b>Megapixel</b>	Yes	
<b>Day/Night</b>	Yes (with removable IR-cut filter)	
<b>Focal Length</b>	GV-BX1200-0F	4 mm
	GV-BX1300-0F	
	GV-BX1500-0F	
	GV-BX2400-0F	
	GV-BX2500-0F	
	GV-BX3400-0F	
	GV-BX1200-1F	8 mm
	GV-BX1300-1F	
	GV-BX1500-1F	
	GV-BX2400-1F	
	GV-BX2500-1F	
	GV-BX3400-1F	
	GV-BX1200-2F	12 mm
	GV-BX1300-2F	
	GV-BX1500-2F	
	GV-BX2400-2F	
	GV-BX2500-2F	
	GV-BX3400-2F	
	GV-BX1500-8F	2.8 mm
	GV-BX2400-8F	
GV-BX2500-8F		
GV-BX3400-8F		
GV-BX5300-8F		

<b>Maximum Aperture</b>	<b>GV-BX1200-0F</b> <b>GV-BX1300-0F</b> <b>GV-BX1500-0F</b> <b>GV-BX2400-0F</b> <b>GV-BX2500-0F</b> <b>GV-BX3400-0F</b>	F/1.5
	<b>GV-BX1200-1F</b> <b>GV-BX1200-2F</b> <b>GV-BX1300-1F</b> <b>GV-BX1300-2F</b> <b>GV-BX1500-1F</b> <b>GV-BX1500-2F</b> <b>GV-BX2400-1F</b> <b>GV-BX2400-2F</b> <b>GV-BX2500-1F</b> <b>GV-BX2500-2F</b> <b>GV-BX3400-1F</b> <b>GV-BX3400-2F</b>	F/1.6
	<b>GV-BX1500-8F</b> <b>GV-BX2400-8F</b> <b>GV-BX2500-8F</b> <b>GV-BX3400-8F</b> <b>GV-BX5300-8F</b>	F/1.8
<b>Mount</b>	CS	

## Specifications: Box Camera (Part 2)

<b>Image Format</b>	GV-BX1200-0F	1/3"
	GV-BX1300-0F	
	GV-BX1500-0F	
	GV-BX2400-0F	
	GV-BX2500-0F	
	GV-BX3400-0F	
	GV-BX1200-1F	1/2.5"
	GV-BX1200-2F	
	GV-BX1300-1F	
	GV-BX1300-2F	
	GV-BX1500-1F	
	GV-BX1500-2F	
	GV-BX2400-1F	
	GV-BX2400-2F	
	GV-BX2500-1F	
GV-BX2500-2F		
GV-BX3400-1F		
GV-BX3400-2F		
GV-BX1500-8F	1/2.5"	
GV-BX2400-8F		
GV-BX2500-8F		
GV-BX3400-8F		
GV-BX5300-8F		



<b>Horizontal FOV</b>	<b>GV-BX1200-0F</b>	63°
	<b>GV-BX1300-0F</b>	49°
	<b>GV-BX1500-0F</b>	63°
	<b>GV-BX2400-0F</b>	58°
	<b>GV-BX2500-0F</b>	72°
	<b>GV-BX3400-0F</b>	61°
	<b>GV-BX1200-1F</b>	36°
	<b>GV-BX1300-1F</b>	26°
	<b>GV-BX1500-1F</b>	36°
	<b>GV-BX2400-1F</b>	32°
	<b>GV-BX2500-1F</b>	40°
	<b>GV-BX3400-1F</b>	35°
	<b>GV-BX1200-2F</b>	23°
	<b>GV-BX1300-2F</b>	17°
	<b>GV-BX1500-2F</b>	23°
	<b>GV-BX2400-2F</b>	21°
	<b>GV-BX2500-2F</b>	25°
	<b>GV-BX3400-2F</b>	23°
	<b>GV-BX1500-8F</b>	90°
	<b>GV-BX2400-8F</b>	83°
<b>GV-BX2500-8F</b>	107°	
<b>GV-BX3400-8F</b>	88°	
<b>GV-BX5300-8F</b>	112°	
<b>Operation</b>	<b>Focus</b>	Manual (w/lock)
	<b>Zoom</b>	Fixed
	<b>Iris</b>	Fixed
<b>Torque (Focus Screw)</b>	0.049 N.m	

## Specifications: Box Camera (Part 2)

### Varifocal Lens

(GV-BX1200-3V / BX1300-3V / BX1500-3V / BX2400-3V / BX2400-4V /  
BX2500-3V / BX3400-4V / BX3400-5V / BX5300-6V)

<b>Megapixel</b>	Yes	
<b>Day/Night</b>	Yes (with removable IR-cut filter)	
<b>Focal Length</b>	GV-BX1200-3V GV-BX1300-3V GV-BX1500-3V GV-BX2400-3V GV-BX2500-3V	2.8 ~ 12 mm
	GV-BX2400-4V GV-BX3400-4V	3 ~ 10.5 mm
	GV-BX3400-5V	2.8 ~ 6 mm
	GV-BX5300-6V	4.5 ~ 10 mm
<b>Maximum Aperture</b>	GV-BX1200-3V GV-BX1300-3V GV-BX1500-3V GV-BX2400-3V GV-BX2500-3V	F/1.4
	GV-BX2400-4V GV-BX3400-4V	
	GV-BX3400-5V	F/1.3
	GV-BX5300-6V	F/1.6
<b>Mount</b>	CS	

<b>Image Format</b>		GV-BX1200-3V GV-BX1300-3V GV-BX1500-3V GV-BX2400-3V GV-BX2500-3V GV-BX2400-4V GV-BX3400-4V	1/2.7"	
		GV-BX3400-5V	1/3"	
		GV-BX5300-6V	1/2"	
<b>Horizontal FOV</b>		GV-BX1200-3V	87° ~ 31°	
		GV-BX1300-3V	64° ~ 23°	
		GV-BX1500-3V	86° ~ 31°	
		GV-BX2400-3V	77° ~ 28°	
		GV-BX2500-3V	105° ~ 36°	
		GV-BX2400-4V	73° ~ 27°	
		GV-BX3400-4V	78° ~ 28°	
		GV-BX3400-5V	94° ~ 45°	
		GV-BX5300-6V	70° ~ 34°	
<b>Operation</b>	<b>Focus</b>	Manual (w/lock)		
	<b>Zoom</b>	Manual (w/lock)		
	<b>Iris</b>	GV-BX1200-3V GV-BX1300-3V GV-BX1500-3V GV-BX2400-3V GV-BX2500-3V GV-BX2400-4V GV-BX3400-4V GV-BX3400-5V	DC drive	
		GV-BX5300-6V	Manual (w/lock)	

## Specifications: Box Camera (Part 2)

<b>Torque (Focus / Zoom screws)</b>	0.049 N.m
---	-----------

### Operation

<b>Video Compression</b>		H.264, MJPEG
<b>Video Stream</b>		Dual streams from H. 264 or MJPEG
<b>Frame Rate</b>	<b>GV-BX1200 Series GV-BX1300 Series GV-BX1500 Series</b>	30 fps at 1280 x 1024
	<b>GV-BX2400 Series GV-BX2500 Series</b>	30 fps at 1920 x 1080
	<b>GV-BX3400 Series</b>	20 fps at 2048 x 1536
		30 fps at 1920 x 1080
	<b>GV-BX5300 Series</b>	10 fps at 2560 x 1920
<b>Image Setting</b>		Brightness, Contrast, Saturation, Sharpness, Gamma, White Balance, Flicker-less, Image Orientation, Shutter Speed, D/N Sensitivity, Backlight Compensation, WDR, Defog, Super Low Lux
<b>Audio Compression</b>		G.711, AAC (Optional)
<b>Audio Support</b>		Two-Way Audio
<b>Sensor Input</b>		1 input (Dry Contact)
<b>Alarm Output</b>		1 Digital Output (200mA 5V DC)
<b>Note:</b>		
<ol style="list-style-type: none"> <li>The frame rate and performance may vary depending on the number of connections and data bitrates (different scenes).</li> <li>The Super Low Lux adjustment (Image Settings) is only available for GV-BX1500 Series / 2500 Series.</li> </ol>		

## Video Resolution

<b>GV-BX1200 Series</b> <b>GV-BX1300 Series</b> <b>GV-BX1500 Series</b>	<b>Main Stream</b>	<b>4:3</b>	1280 x 960, 640 x 480, 320 x 240
		<b>16:9</b>	1280 x 720, 640 x 360, 448 x 252
		<b>5:4</b>	1280 x 1024, 640 x 512, 320 x 256
	<b>Sub Stream</b>	<b>4:3</b>	640 x 480, 320 x 240
		<b>16:9</b>	640 x 360, 448 x 252
		<b>5:4</b>	640 x 512, 320 x 256
<b>GV-BX2400 Series</b> <b>GV-BX2500 Series</b>	<b>Main Stream</b>	<b>4:3</b>	1600 x 1200, 1280 x 960, 640 x 480, 320 x 240
		<b>16:9</b>	1920 x 1080, 1280 x 720, 640 x 360, 448 x 252
		<b>5:4</b>	1280 x 1024, 640 x 512, 320 x 256
	<b>Sub Stream</b>	<b>4:3</b>	640 x 480, 320 x 240
		<b>16:9</b>	640 x 360, 448 x 252
		<b>5:4</b>	640 x 512, 320 x 256
<b>GV-BX3400 Series</b>	<b>Main Stream</b>	<b>4:3</b>	2048 x 1536, 1600 x 1200, 1280 x 960, 640 x 480, 320 x 240
		<b>16:9</b>	1920 x 1080, 1280 x 720, 640 x 360, 448 x 252
		<b>5:4</b>	1280 x 1024, 640 x 512, 320 x 256
	<b>Sub Stream</b>	<b>4:3</b>	640 x 480, 320 x 240
		<b>16:9</b>	640 x 360, 448 x 252
		<b>5:4</b>	640 x 512, 320 x 256

## Specifications: Box Camera (Part 2)

GV-BX5300 Series	Main Stream	4:3	2560 x 1920, 2048 x 1536, 1600 x 1200, 1280 x 960, 640 x 480, 320 x 240
		16:9	1920 x 1080, 1280 x 720, 640 x 360, 448 x 252
		5:4	1280 x 1024, 640 x 512, 320 x 256
	Sub Stream	4:3	640 x 480, 320 x 240
		16:9	640 x 360, 448 x 252
		5:4	640 x 512, 320 x 256

## Network

Interface	10/100 Ethernet
Protocol	DHCP, DynDNS, FTP, HTTP, HTTPS, NTP, ONVIF (Profile S), PSIA, QoS (DSCP), RTSP, SNMP, SMTP, TCP, UDP, UPnP, 3GPP/ISMA
Wireless LAN	IEEE 802.11 b/g/n
Antenna Type	External
Security	WEP, WPA-PSK(TKIP), WPA-PSK(AES), WPA2-PSK(TKIP), WPA2-PSK(AES)
<p><b>Note:</b> The signal range and data throughput may vary depending on the network conditions and environmental factors.</p>	

## Mechanical

Temperature Detector	Yes	
Connectors	Power	2-pin terminal block, PoE
	Ethernet	Ethernet (10/100 Base-T), RJ-45 cable

<b>Connectors</b>	<b>Audio</b>	1 In (Using the built-in microphone or externally connecting a microphone) 1 Out (Stereo phone jack, 3.5 mm / 0.14")	
	<b>Auto Iris</b>	GV-BX1200 Series GV-BX1300 Series GV-BX1500 Series GV-BX2400 Series GV-BX2500 Series GV-BX3400 Series	Yes (with varifocal lens)
		GV-BX5300 Series	Not functional
	<b>Local Storage</b>	Micro SD card slot (SD/SDHC, version 2.0 only, Class 10)	
	<b>TV-Out</b>	BNC connector (640 x 480 resolution)	
	<b>Digital I/O</b>	3-pin terminal block, pitch 2.5 mm / 0.1"	
	<b>Mini USB</b>	GV-WiFi Adapter or USB hard drive	
	<b>LED Indicator</b>		2 LEDs: Power, Status
<p><b>Note:</b></p> <ol style="list-style-type: none"> <li>SDXC and UHS-I card types are not supported.</li> <li>The TV-Out function only works in 640 x 480 resolution. For TV-Out to work properly, you must set the video resolution to 1280 x 1024 or lower. If both streams are enabled, the Sub Stream must be set to 640 x 480.</li> <li>Mind the following limitations and requirements for the mini USB port: <ul style="list-style-type: none"> <li>The USB hard drive must be of 2.5" or 3.5", version 2.0 or above</li> <li>The USB hard drive's storage capacity must not exceed 2TB</li> <li>USB flash drives and USB hubs are not supported</li> <li>External power supply is required for the USB hard drive</li> <li>To connect a GV-WiFi Adapter, make sure it is connected before the camera is powered on.</li> </ul> </li> </ol>			

## Specifications: Box Camera (Part 2)

### General

<b>Environment Temperature</b>		0°C ~ 50°C (32°F ~ 122°F)
<b>Humidity</b>		10% to 90% (no condensation)
<b>Power Source</b>		12V DC / PoE
<b>Max. Power Consumption</b>	GV-BX1200 Series GV-BX1300 Series GV-BX1500 Series GV-BX2400 Series GV-BX3400 Series GV-BX5300 Series	9.5 W
	GV-BX2500 Series	7.99 W
<b>Dimensions (L X W X H)</b>		(Without lens) 75.5 x 75 x 54 mm (2.97" x 2.95" x 2.13")
<b>Weight</b>		300 g (0.66 lb)
<b>Regulatory</b>	GV-BX1200 Series GV-BX1300 Series GV-BX2400 Series GV-BX3400 Series GV-BX5300 Series	CE, FCC, C-Tick, RoHS compliant
	GV-BX1500 Series GV-BX2500 Series	CE, FCC, RCM, RoHS compliant

### Power over Ethernet

<b>PoE Standard</b>	IEEE 802.3af Class 3 Power over Ethernet / PD
<b>PoE Power Supply Type</b>	End-Span
<b>PoE Power Output</b>	Per Port 48V DC, 350mA. Max. 15.4 watts



## Web Interface

<b>Installation Management</b>	Web-based configuration
<b>Maintenance</b>	Firmware upgrade through Web Browser or Utility
<b>Access from Web Browser</b>	Camera live view, video recording, change video quality, bandwidth control, image snapshot, digital I/O control, audio, Picture in Picture, Picture and Picture, Privacy Mask, Visual Automation, Tampering Alarm, Text Overlay, Digital PTZ
<b>Language</b>	Arabic / Bulgarian / Czech / Danish / Dutch / English / Finnish / French / German / Greek / Hebrew / Hungarian / Indonesian / Italian / Japanese / Lithuanian / Norwegian / Persian / Polish / Portuguese / Romanian / Russian / Serbian / Simplified Chinese / Slovakian / Slovenian / Spanish / Swedish / Thai / Traditional Chinese / Turkish

## Application

<b>Network Storage</b>	GV-NVR, GV-System, GV-Backup Center, GV-Recording Server
<b>Smart Device Access</b>	GV-Eye for Android smartphone, tablet, iPhone, and iPod Touch; GV-Eye HD for iPad
<b>Live Viewing</b>	IE, mobile phone
<b>CMS Server support</b>	GV-Control Center, GV-Center V2, GV-VSM

All specifications are subject to change without notice.

## Specifications: Ultra Box Camera

### Camera

<b>Image Sensor</b>		1/2.5" progressive scan CMOS
<b>Picture Elements</b>	<b>GV-UBX1301 Series</b>	1280 (H) x 1024 (V)
	<b>GV-UBX2301 Series</b>	1920 (H) x 1080 (V)
	<b>GV-UBX3301 Series</b>	2048 (H) x 1536 (V)
<b>Minimum Illumination</b>	<b>Color</b>	0.15 Lux
	<b>B/W</b>	0.10 Lux
	<b>IR ON</b>	0 Lux
<b>Shutter Speed</b>	Automatic, Manual (1/5 ~ 1/8000 sec)	
<b>White Balance</b>	Automatic, Manual (2800K ~ 8500K)	
<b>Gain Control</b>	Automatic	
<b>S/N Ratio</b>	50 dB	
<b>WDR</b>	Yes	

### Lens

<b>Megapixel</b>	Yes	
<b>Day/Night</b>	Yes (with removable IR-cut filter)	
<b>Lens Type</b>	Fixed	
<b>Focal Length</b>	GV-UBX1301-0F GV-UBX2301-0F GV-UBX3301-0F	3 mm

Focal Length	GV-UBX1301-1F GV-UBX2301-1F GV-UBX3301-1F	4 mm
	GV-UBX1301-2F GV-UBX2301-2F GV-UBX3301-2F	8 mm
Maximum Aperture	GV-UBX1301-0F GV-UBX2301-0F GV-UBX3301-0F GV-UBX1301-1F GV-UBX2301-1F GV-UBX3301-1F GV-UBX1301-2F GV-UBX2301-2F GV-UBX3301-2F	F/1.6
Mount	M12, Pitch 0.5 mm	
Image Format	1/3"	
Horizontal FOV	GV-UBX1301-0F	66°
	GV-UBX1301-1F	49°
	GV-UBX1301-2F	25°
	GV-UBX2301-0F	80°
	GV-UBX2301-1F	58°
	GV-UBX2301-2F	31°
	GV-UBX3301-0F	87°
	GV-UBX3301-1F	62°
	GV-UBX3301-2F	33°
Operation (Focus / Zoom / Iris)	Fixed	
IR LED Quantity	4 IR LEDs	
Max. IR Distance	10 m (32.81 ft)	

## Specifications: Ultra Box Camera

### Operation

<b>Video Compression</b>		H.264, MJPEG
<b>Video Stream</b>		Dual streams from H. 264 or MJPEG
<b>Frame Rate</b>	<b>GV-UBX1301 Series</b>	30 fps at 1280 x 1024
	<b>GV-UBX2301 Series</b>	30 fps at 1920 x 1080
	<b>GV-UBX3301 Series</b>	20 fps at 2048 x 1536
<b>Image Setting</b>		Brightness, Contrast, Saturation, Sharpness, Gamma, White Balance, Flicker-less, Image Orientation, Shutter Speed, D/N Sensitivity, Backlight Compensation, WDR, Defog
<b>Audio Compression</b>		G.711, AAC (Optional)
<b>Audio Support</b>		Two-Way Audio
<b>Note:</b> The frame rate and performance may vary depending on the number of connections and data bitrates (different scenes).		

### Video Resolution

<b>GV-UBX1301 Series</b>	<b>Main Stream</b>	<b>4:3</b>	1280 x 960, 640 x 480, 320 x 240
		<b>16:9</b>	1280 x 720, 640 x 360, 448 x 252
		<b>5:4</b>	1280 x 1024, 640 x 512, 320 x 256
	<b>Sub Stream</b>	<b>4:3</b>	640 x 480, 320 x 240
		<b>16:9</b>	640 x 360, 448 x 252
		<b>5:4</b>	640 x 512, 320 x 256

<b>GV-UBX2301 Series</b>	<b>Main Stream</b>	<b>4:3</b>	1600 x 1200, 1280 x 960, 640 x 480, 320 x 240
		<b>16:9</b>	1920 x 1080, 1280 x 720, 640 x 360, 448 x 252
		<b>5:4</b>	1280 x 1024, 640 x 512, 320 x 256
	<b>Sub Stream</b>	<b>4:3</b>	640 x 480, 320 x 240
		<b>16:9</b>	640 x 360, 448 x 252
		<b>5:4</b>	640 x 512, 320 x 256
<b>GV-UBX3301 Series</b>	<b>Main Stream</b>	<b>4:3</b>	2048 x 1536, 1600 x 1200, 1280 x 960, 640 x 480, 320 x 240
		<b>16:9</b>	1920 x 1080, 1280 x 720, 640 x 360, 448 x 252
		<b>5:4</b>	1280 x 1024, 640 x 512, 320 x 256
	<b>Sub Stream</b>	<b>4:3</b>	640 x 480, 320 x 240
		<b>16:9</b>	640 x 360, 448 x 252
		<b>5:4</b>	640 x 512, 320 x 256

## Network

<b>Interface</b>	10/100 Ethernet
<b>Protocol</b>	DHCP, DynDNS, FTP, HTTP, HTTPS, NTP, ONVIF (Profile S), PSIA, QoS (DSCP), RTSP, SNMP, SMTP, TCP, UDP, UPnP, 3GPP/ISMA

## Specifications: Ultra Box Camera

### Mechanical

<b>Temperature Detector</b>		Yes
<b>Connectors</b>	<b>Power</b>	2-pin terminal block, PoE
	<b>Ethernet</b>	Ethernet (10/100 Base-T), RJ-45 cable
	<b>Audio</b>	1 In (Using the built-in microphone) 1 Out (Stereo phone jack, 3.5 mm / 0.14")
	<b>Local Storage</b>	Micro SD card slot (SD/SDHC, version 2.0 only, Class 10)
<b>LED Indicator</b>		2 LEDs: Power, Status
<b>Note:</b> SDXC and UHS-I card types are not supported.		

### General

<b>Environment Temperature</b>	0°C ~ 40°C (32°F ~ 104°F)
<b>Humidity</b>	10% to 90% (no condensation)
<b>Power Source</b>	5V DC / PoE
<b>Max. Power Consumption</b>	6.5 W
<b>Dimensions</b>	95 x 45 x 40 mm (3.7" x 1.8" x 1.6")
<b>Weight</b>	120 g (0.26 lb)
<b>Regulatory</b>	CE, FCC, C-Tick, RoHS compliant

### Power over Ethernet

<b>PoE Standard</b>	IEEE 802.3af Class 3 Power over Ethernet / PD
<b>PoE Power Supply Type</b>	End-Span
<b>PoE Power Output</b>	Per Port 48V DC, 350mA. Max. 15.4 watts

## Web Interface

<b>Installation Management</b>	Web-based configuration
<b>Maintenance</b>	Firmware upgrade through Web Browser or Utility
<b>Access from Web Browser</b>	Camera live view, video recording, change video quality, bandwidth control, image snapshot, audio, Picture in Picture, Picture and Picture, Privacy Mask, Tampering Alarm, Text Overlay, Digital PTZ
<b>Language</b>	Arabic / Bulgarian / Czech / Danish / Dutch / English / Finnish / French / German / Greek / Hebrew / Hungarian / Indonesian / Italian / Japanese / Lithuanian / Norwegian / Persian / Polish / Portuguese / Romanian / Russian / Serbian / Simplified Chinese / Slovakian / Slovenian / Spanish / Swedish / Thai / Traditional Chinese / Turkish

## Application

<b>Network Storage</b>	GV-NVR, GV-System, GV-Backup Center, GV-Recording Server
<b>Smart Device Access</b>	GV-Eye for Android smartphone, tablet, iPhone, and iPod Touch; GV-Eye HD for iPad
<b>Live Viewing</b>	IE, mobile phone
<b>CMS Server support</b>	GV-Control Center, GV-Center V2, GV-VSM

All specifications are subject to change without notice.

# Specifications: Target Box Camera

## Camera

<b>Image Sensor</b>		1/3" progressive scan low lux CMOS
<b>Picture Elements</b>		1280 (H) x 1024 (V)
<b>Minimum Illumination</b>	<b>Color</b>	0.05 Lux
	<b>B/W</b>	0.03 Lux
	<b>IR ON</b>	0 Lux
<b>Shutter Speed</b>		Automatic, Manual (1/5 ~ 1/8000 sec)
<b>White Balance</b>		Automatic, Manual (2800K ~ 8500K)
<b>Gain Control</b>		Automatic
<b>S/N Ratio</b>		50 dB
<b>WDR</b>		Yes

## Lens

<b>Megapixel</b>		Yes
<b>Day/Night</b>		Yes (with removable IR-cut filter)
<b>Lens Type</b>		Fixed
<b>Focal Length</b>	<b>GV-EBX1100-0F</b>	2.8 mm
	<b>GV-EBX1100-1F</b>	3.8 mm
<b>Maximum Aperture</b>		F/1.8
<b>Mount</b>		M12, Pitch 0.5 mm
<b>Image Format</b>		1/2.7"
<b>Horizontal FOV</b>	<b>GV-EBX1100-0F</b>	93°
	<b>GV-EBX1100-1F</b>	64°
<b>Operation (Focus / Zoom / Iris)</b>		Fixed
<b>IR LED Quantity</b>		8 IR LEDs



<b>Max. IR Distance</b>	15 m (50 ft)
-------------------------	--------------

## Operation

<b>Video Compression</b>	H.264, MJPEG
<b>Video Stream</b>	Dual streams from H. 264 or MJPEG
<b>Frame Rate</b>	30 fps at 1280 x 1024
<b>Image Setting</b>	Brightness, Contrast, Saturation, Sharpness, Gamma, White Balance, Flicker-less, Image Orientation, Shutter Speed, D/N Sensitivity, Backlight Compensation, WDR, Defog
<b>Audio Compression</b>	G.711, AAC (Optional)
<b>Audio Support</b>	One-Way Audio
<b>Note:</b> The frame rate and performance may vary depending on the number of connections and data bitrates (different scenes).	

## Video Resolution

<b>Main Stream</b>	<b>4:3</b>	1280 x 960, 640 x 480, 320 x 240
	<b>16:9</b>	1280 x 720, 640 x 360, 448 x 252
	<b>5:4</b>	1280 x 1024, 640 x 512, 320 x 256
<b>Sub Stream</b>	<b>4:3</b>	640 x 480, 320 x 240
	<b>16:9</b>	640 x 360, 448 x 252
	<b>5:4</b>	640 x 512, 320 x 256

## Network

<b>Interface</b>	10/100 Ethernet
<b>Protocol</b>	DHCP, DynDNS, FTP, HTTP, HTTPS, NTP, ONVIF (Profile S), QoS (DSCP), RTSP, SNMP, SMTP, TCP, UDP, UPnP, 3GPP/ISMA

## Specifications: Target Box Camera

### Mechanical

<b>Connectors</b>	<b>Power</b>	2-pin terminal block, PoE
	<b>Ethernet</b>	Ethernet (10/100 Base-T), RJ-45 cable
	<b>Audio</b>	1 In (built-in microphone)
<b>LED Indicator</b>		2 LEDs: Power, Status

### General

<b>Environment Temperature</b>	0°C ~ 50°C (32°F ~ 122°F)
<b>Humidity</b>	10% to 90% (no condensation)
<b>Power Source</b>	12V DC / PoE
<b>Max. Power Consumption</b>	5.36 W
<b>Dimensions</b>	95 x 45 x 40 mm (3.7" x 1.8" x 1.6")
<b>Weight</b>	120 g (0.26 lb)
<b>Regulatory</b>	CE, FCC, C-Tick, RCM, RoHS compliant

### Power over Ethernet

<b>PoE Standard</b>	IEEE 802.3af Power over Ethernet / PD
<b>PoE Power Supply Type</b>	End-Span
<b>PoE Power Output</b>	Per Port 48V DC, 350mA. Max. 15.4 watts

## Web Interface

<b>Installation Management</b>	Web-based configuration
<b>Maintenance</b>	Firmware upgrade through Web Browser or Utility
<b>Access from Web Browser</b>	Camera live view, video recording, change video quality, bandwidth control, image snapshot, audio, Picture in Picture, Picture and Picture, Privacy Mask, Tampering Alarm, Text Overlay, Digital PTZ
<b>Language</b>	Arabic / Bulgarian / Czech / Danish / Dutch / English / Finnish / French / German / Greek / Hebrew / Hungarian / Indonesian / Italian / Japanese / Lithuanian / Norwegian / Persian / Polish / Portuguese / Romanian / Russian / Serbian / Simplified Chinese / Slovakian / Slovenian / Spanish / Swedish / Thai / Traditional Chinese / Turkish

## Application

<b>Network Storage</b>	GV-NVR, GV-System, GV-Recording Server
<b>Smart Device Access</b>	GV-Eye for Android smartphone, tablet, iPhone, and iPod Touch; GV-Eye HD for iPad
<b>Live Viewing</b>	IE, mobile phone
<b>CMS Server support</b>	GV-Control Center, GV-Center V2, GV-VSM

All specifications are subject to change without notice.

# Specifications: IR Arctic Box

## Camera

### Camera

Image Sensor	GV-BX120D-E	1/3" progressive scan low lux CMOS	
	GV-BX1500-E	1/3" progressive scan super low lux CMOS	
	GV-BX2400-E GV-BX3400-E	1/3.2" progressive scan CMOS	
	GV-BX220D-E GV-BX320D-E GV-BX520D-E GV-BX5300-E	1/2.5" progressive scan CMOS	
	Picture Elements	GV-BX120D-E GV-BX1500-E	1280 (H) x 1024 (V)
GV-BX220D-E GV-BX2400-E		1920 (H) x 1080 (V)	
GV-BX320D-E GV-BX3400-E		2048 (H) x 1536 (V)	
GV-BX520D-E GV-BX5300-E		2560 (H) x 1920 (V)	
Minimum Illumination	GV-BX120D-E	Color	0.05 Lux
		B/W	0.03 Lux
		IR ON	0 Lux
	GV-BX1500-E	Color	0.01 Lux
		B/W	0.01 Lux
		IR ON	0 Lux
		IR ON	0 Lux

Minimum Illumination	GV-BX2400-E GV-BX3400-E	Color	0.08 Lux
		B/W	0.05 Lux
		IR ON	0 Lux
	GV-BX220D-E GV-BX320D-E GV-BX520D-E GV-BX5300-E	Color	0.15 Lux
		B/W	0.10 Lux
		IR ON	0 Lux
Shutter Speed		Automatic, Manual (1/5 ~ 1/8000 sec)	
White Balance		Automatic, Manual (2800K ~ 8500K)	
Gain Control		Automatic	
S/N Ratio	GV-BX120D-E	50 dB	
	GV-BX1500-E	55 dB	
	GV-BX2400-E GV-BX3400-E	47 dB	
	GV-BX220D-E GV-BX320D-E GV-BX520D-E GV-BX5300-E	45 dB	
	WDR Pro	GV-BX2400-E GV-BX3400-E	Yes
WDR		Yes	

## Lens

Megapixel		Yes
Day/Night		Yes (with removable IR-cut filter)
Lens Type		Varifocal
Focal Length	GV-BX120D-E	2.8 ~ 12 mm

## Specifications: IR Arctic Box Camera

Focal Length	GV-BX220D-E GV-BX320D-E	2.8 ~ 6 mm
	GV-BX1500-E GV-BX2400-E GV-BX3400-E	3 ~ 10.5 mm
	GV-BX520D-E GV-BX5300-E	4.5 ~ 10 mm
Maximum Aperture	GV-BX120D-E GV-BX1500-E GV-BX2400-E GV-BX3400-E	F/1.4
	GV-BX220D-E GV-BX320D-E	F/1.3
	GV-BX520D-E GV-BX5300-E	F/1.6
Mount		CS
Image Format	GV-BX120D-E GV-BX220D-E GV-BX320D-E	1/3"
	GV-BX1500-E GV-BX2400-E GV-BX3400-E	1/2.7"
	GV-BX520D-E GV-BX5300-E	1/2"
Horizontal FOV	GV-BX1500-E	81° ~ 29°
	GV-BX2400-E	73° ~ 27°
	GV-BX3400-E	78° ~ 28°
	GV-BX5300-E	70° ~ 34°
Operation	Focus	Manual (w/lock)
	Zoom	Manual (w/lock)

<b>Operation</b>	<b>Iris</b>	<b>GV-BX120D-E</b> <b>GV-BX1500-E</b> <b>GV-BX220D-E</b> <b>GV-BX2400-E</b> <b>GV-BX320D-E</b> <b>GV-BX3400-E</b>	DC drive
		<b>GV-BX520D-E</b> <b>GV-BX5300-E</b>	Manual (w/lock)
<b>IR Quantity</b>		4	
<b>Max. IR Distance</b>		15 m (50 ft)	
<b>Max. Torque (Focus/Zoom screws)</b>		0.049 N.m	

## Operation

<b>Video Compression</b>		H.264, MJPEG
<b>Video Stream</b>		Dual streams from H.264 or MJPEG
<b>Frame Rate</b>	<b>GV-BX120D-E</b> <b>GV-BX1500-E</b>	30 fps at 1280 x 1024
	<b>GV-BX220D-E</b> <b>GV-BX2400-E</b>	30 fps at 1920 x 1080
	<b>GV-BX320D-E</b>	20 fps at 2048 x 1536
	<b>GV-BX3400-E</b>	30 fps at 1920 x 1080
	<b>GV-BX520D-E</b> <b>GV-BX5300-E</b>	10 fps at 2560 x 1920
<b>Image Setting</b>		Brightness, Contrast, Saturation, Sharpness, Gamma, White Balance, Flicker-less, Image Orientation, Shutter Speed, D/N Sensitivity, Backlight Compensation, WDR, Defog, Super Low Lux

## Specifications: IR Arctic Box Camera

<b>Audio Compression</b>	G.711, AAC (Optional)
<b>Audio Support</b>	Two-Way Audio
<b>Note:</b>	
<ol style="list-style-type: none"> <li>The frame rate and performance may vary depending on the number of connections and data bitrates (different scenes).</li> <li>The super low lux adjustment (Image Settings) is only available for GV-BX1500-E.</li> </ol>	

### Video Resolution

<b>GV-BX120D-E</b>	<b>Main Stream</b>	<b>4:3</b>	1280 x 960, 640 x 480, 320 x 240
		<b>16:9</b>	1280 x 720, 640 x 360, 448 x 252
		<b>5:4</b>	1280 x 1024, 640 x 512, 320 x 256
	<b>Sub Stream</b>	<b>4:3</b>	640 x 480, 320 x 240
		<b>16:9</b>	640 x 360, 448 x 252
		<b>5:4</b>	640 x 512, 320 x 256
<b>GV-BX220D-E</b>	<b>Main Stream</b>	<b>4:3</b>	1600 x 1200, 1280 x 960, 640 x 480, 320 x 240
		<b>16:9</b>	1920 x 1080, 1280 x 720, 640 x 360, 448 x 252
		<b>5:4</b>	1280 x 1024, 640 x 512, 320 x 256
	<b>Sub Stream</b>	<b>4:3</b>	640 x 480, 320 x 240
		<b>16:9</b>	640 x 360, 448 x 252
		<b>5:4</b>	640 x 512, 320 x 256
<b>GV-BX320D-E</b>	<b>Main Stream</b>	<b>4:3</b>	2048 x 1536, 1600 x 1200, 1280 x 960, 640 x 480, 320 x 240
		<b>16:9</b>	1920 x 1080, 1280 x 720, 640 x 360, 448 x 252
		<b>5:4</b>	1280 x 1024, 640 x 512, 320 x 256



<b>GV-BX320D-E</b>	<b>Sub Stream</b>	<b>4:3</b>	640 x 480, 320 x 240
		<b>16:9</b>	640 x 360, 448 x 252
		<b>5:4</b>	640 x 512, 320 x 256
<b>GV-BX520D-E</b>	<b>Main Stream</b>	<b>4 : 3</b>	2560 x 1920, 2048 x 1536, 1600 x 1200, 1280 x 960, 640 x 480, 320 x 240
		<b>16 : 9</b>	1920 x 1080, 1280 x 720, 640 x 360, 448 x 252
		<b>5 : 4</b>	1280 x 1024, 640 x 512, 320 x 256
	<b>Sub Stream</b>	<b>4 : 3</b>	640 x 480, 320 x 240
		<b>16 : 9</b>	640 x 360, 448 x 252
		<b>5 : 4</b>	640 x 512, 320 x 256
<b>GV-BX1500-E</b>	<b>Main Stream</b>	<b>4:3</b>	1280 x 960, 640 x 480, 320 x 240
		<b>16:9</b>	1280 x 720, 640 x 360, 448 x 252
		<b>5:4</b>	1280 x 1024, 640 x 512, 320 x 256
	<b>Sub Stream</b>	<b>4:3</b>	640 x 480, 320 x 240
		<b>16:9</b>	640 x 360, 448 x 252
		<b>5:4</b>	640 x 512, 320 x 256
<b>GV-BX2400-E</b>	<b>Main Stream</b>	<b>4:3</b>	1600 x 1200, 1280 x 960, 640 x 480, 320 x 240
		<b>16:9</b>	1920 x 1080, 1280 x 720, 640 x 360, 448 x 252
		<b>5:4</b>	1280 x 1024, 640 x 512, 320 x 256
	<b>Sub Stream</b>	<b>4:3</b>	640 x 480, 320 x 240
		<b>16:9</b>	640 x 360, 448 x 252
		<b>5:4</b>	640 x 512, 320 x 256

## Specifications: IR Arctic Box Camera

<b>GV-BX3400-E</b>	<b>Main Stream</b>	<b>4:3</b>	2048 x 1536, 1600 x 1200, 1280 x 960, 640 x 480, 320 x 240
		<b>16:9</b>	1920 x 1080, 1280 x 720, 640 x 360, 448 x 252
		<b>5:4</b>	1280 x 1024, 640 x 512, 320 x 256
	<b>Sub Stream</b>	<b>4:3</b>	640 x 480, 320 x 240
		<b>16:9</b>	640 x 360, 448 x 252
		<b>5:4</b>	640 x 512, 320 x 256
<b>GV-BX5300-E</b>	<b>Main Stream</b>	<b>4 : 3</b>	2560 x 1920, 2048 x 1536, 1600 x 1200, 1280 x 960, 640 x 480, 320 x 240
		<b>16 : 9</b>	1920 x 1080, 1280 x 720, 640 x 360, 448 x 252
		<b>5 : 4</b>	1280 x 1024, 640 x 512, 320 x 256
	<b>Sub Stream</b>	<b>4 : 3</b>	640 x 480, 320 x 240
		<b>16 : 9</b>	640 x 360, 448 x 252
		<b>5 : 4</b>	640 x 512, 320 x 256

### Network

<b>Interface</b>	10/100 Ethernet
<b>Protocol</b>	DHCP, DynDNS, FTP, HTTP, HTTPS, NTP, ONVIF (Profile S), PSIA, QoS (DSCP), RTSP, SNMP, SMTP, TCP, UDP, UPnP, 3GPP/ISMA

## Mechanical

<b>Camera Angle Adjustment</b>	<b>Pan</b>	0° ~ 330°		
	<b>Tilt</b>	0° ~ 90°		
<b>Temperature Detector</b>		Yes		
<b>Connectors</b>	<b>Power</b>	PoE		
	<b>Ethernet</b>	Ethernet (10/100 Base-T), RJ-45 cable		
	<b>Audio</b>	1 In (externally connecting a microphone) 1 Out (Stereo phone jack, 3.5 mm / 0.14")		
	<b>Auto Iris</b>	GV-BX120D-E GV-BX1500-E GV-BX220D-E GV-BX2400-E GV-BX320D-E GV-BX3400-E	DC Drive	
		GV-BX520D-E GV-BX5300-E	Not functional	
	<b>TV-Out</b>	BNC connector (640 x 480 resolution)		
	<b>LED Indicator</b>		1 LED: Status	
<p><b>Note:</b> The TV-Out function only works in 640 x 480 resolution. For TV-Out to work properly, you must set the video resolution to 1280 x 1024 or lower. If both streams are enabled, the Sub Stream must be set to 640 x 480.</p>				

## General

<b>Environment Temperature</b>	<b>Start-up</b>	-30°C ~ 50°C (-22°F ~ 122°F)
	<b>Operation</b>	-40°C ~ 50°C (-40°F ~ 122°F)
<b>Humidity</b>		10% to 90% (no condensation)
<b>Power Source</b>		PoE (IEEE 802.3at)

## Specifications: IR Arctic Box Camera

Max. Power Consumption	GV-BX120D-E GV-BX220D-E GV-BX320D-E GV-BX520D-E	24 W
	GV-BX1500-E	20 W
	GV-BX2400-E GV-BX3400-E	23 W
	GV-BX5300-E	21.6 W
	Dimensions	
Weight		3.2 kg (7.11 lb)
Regulatory	GV-BX120D-E GV-BX220D-E GV-BX320D-E GV-BX520D-E GV-BX2400-E GV-BX3400-E GV-BX5300-E	CE, FCC, C-Tick, RoHS compliant
	GV-BX1500-E	CE, FCC, RCM, RoHS compliant
Ingress Protection		IP67
Vandal Resistance		IK10 for metal casing
Heater On		-40°C ~ 8°C (-40°F ~ 46.4°F)
Fan		Constantly on

### Power over Ethernet

PoE Standard	IEEE 802.3at Power over Ethernet / PD
PoE Power Supply Type	End-Span
PoE Power Output	Per Port 48V DC, 600mA. Max. 34.2 watts

## Web Interface

<b>Installation Management</b>	Web-based configuration
<b>Maintenance</b>	Firmware upgrade through Web Browser or Utility
<b>Access from Web Browser</b>	Camera live view, video recording, change video quality, bandwidth control, image snapshot, audio, Picture in Picture, Picture and Picture, Privacy Mask, Tampering Alarm, Text Overlay, Digital PTZ
<b>Language</b>	Arabic / Bulgarian / Czech / Danish / Dutch / English / Finnish / French / German / Greek / Hebrew / Hungarian / Indonesian / Italian / Japanese / Lithuanian / Norwegian / Persian / Polish / Portuguese / Romanian / Russian / Serbian / Simplified Chinese / Slovakian / Slovenian / Spanish / Swedish / Thai / Traditional Chinese / Turkish

## Application

<b>Network Storage</b>	GV-NVR, GV-System, GV-Backup Center, GV-Recording Server
<b>Smart Device Access</b>	GV-Eye for Android smartphone, tablet, iPhone, and iPod Touch; GV-Eye HD for iPad
<b>Live Viewing</b>	IE, mobile phone
<b>CMS Server support</b>	GV-Control Center, GV-Center V2, GV-VSM

## Specifications: IR Arctic Box Camera

### Specifications: GV-PA481

<b>PoE Standard</b>	IEEE 802.3at Power over Ethernet / PD
<b>PoE Power Output (10/100 Out)</b>	DC 48V, 1A (48W Max.)
<b>Ethernet Cable Length</b>	Max 100 m / 328 ft from GV-PA481 to IP device, CAT5
<b>Power Input</b>	AC 100V ~ 240V, 2A
<b>Operating Temperature</b>	0°C ~ 40°C (32°F ~ 104°F)
<b>Dimensions (L x W x H)</b>	138 x 104 x 38 mm (5.43" x 4.09" x 1.5")
<b>Weight</b>	610 g (13.42 lbs)

All specifications are subject to change without notice.

# Specifications: Mini Fixed Dome

## (Part 1)

This section details the specifications on **GV-MFD120 / 130 / 220 / 320 / 520**.

### Camera

<b>Image Sensor</b>	<b>GV-MFD120</b>	1/3" progressive scan low lux CMOS		
	<b>GV-MFD130</b> <b>GV-MFD220</b> <b>GV-MFD320</b> <b>GV-MFD520</b>	1/2.5" progressive scan CMOS		
	<b>Picture Elements</b>	<b>GV-MFD120</b> <b>GV-MFD130</b>	1280 (H) x 1024 (V)	
		<b>GV-MFD220</b>	1920 (H) x 1080 (V)	
		<b>GV-MFD320</b>	2048 (H) x 1536 (V)	
<b>Picture Elements</b>	<b>GV-MFD520</b>	2560 (H) x 1920 (V)		
<b>Minimum Illumination</b>	<b>GV-MFD120</b>	<b>Color</b>	0.05 Lux	
		<b>B/W</b>	0.03 Lux	
	<b>GV-MFD130</b> <b>GV-MFD220</b> <b>GV-MFD320</b> <b>GV-MFD520</b>	<b>Color</b>	0.15 Lux	
		<b>B/W</b>	0.10 Lux	
<b>Shutter Speed</b>		Automatic, Manual (1/5 ~ 1/8000 sec)		
<b>White Balance</b>		Automatic, Manual (2800K ~ 8500K)		
<b>Gain Control</b>		Automatic		

## Specifications: Mini Fixed Dome (Part 1)

<b>S/N Ratio</b>	<b>GV-MFD120</b>	50 dB
	<b>GV-MFD130</b>	45 dB
	<b>GV-MFD220</b>	
	<b>GV-MFD320</b>	
	<b>GV-MFD520</b>	
<b>WDR</b>		Yes

### Lens

<b>Megapixel</b>		Yes
<b>Day/Night</b>		Yes (electronic)
<b>Lens Type</b>		Fixed
<b>Focal Length</b>	<b>GV-MFD120</b>	4.05 mm
	<b>GV-MFD130</b>	2.54 mm
	<b>GV-MFD220</b>	
	<b>GV-MFD320</b>	
	<b>GV-MFD520</b>	
<b>Maximum Aperture</b>	<b>GV-MFD120</b>	F/1.5
	<b>GV-MFD130</b>	F/2.8
	<b>GV-MFD220</b>	
	<b>GV-MFD320</b>	
	<b>GV-MFD520</b>	
<b>Mount</b>		M12, Pitch 0.5 mm
<b>Image Format</b>	<b>GV-MFD120</b>	1/3"
	<b>GV-MFD130</b>	1/2.5"
	<b>GV-MFD220</b>	
	<b>GV-MFD320</b>	
	<b>GV-MFD520</b>	



<b>Horizontal FOV</b>	<b>GV-MFD120</b>	67°
	<b>GV-MFD130</b>	85°
	<b>GV-MFD220</b>	101°
	<b>GV-MFD320</b>	110°
	<b>GV-MFD520</b>	138°
<b>Operation (Focus / Zoom / Iris)</b>		Fixed
<b>Note:</b> For GV-MFD, the day/night function is only supported by V1.07 or later.		

## Operation

<b>Video Compression</b>		H.264, MJPEG
<b>Video Stream</b>		Dual streams from H.264 or MJPEG
<b>Frame Rate</b>	<b>GV-MFD120</b> <b>GV-MFD130</b>	30 fps at 1280 x 1024
	<b>GV-MFD220</b>	30 fps at 1920 x 1080
	<b>GV-MFD320</b>	20 fps at 2048 x 1536
	<b>GV-MFD520</b>	10 fps at 2560 x 1920
	<b>Image Setting</b>	
<b>Audio Compression</b>		G.711, AAC (Optional)
<b>Audio Support</b>		One-Way Audio
<b>Sensor Input</b>		No
<b>Alarm Output</b>		No
<b>Note:</b> The frame rate and performance may vary depending on the number of connections and data bitrates (different scenes).		

## Specifications: Mini Fixed Dome (Part 1)

### Video Resolution

<b>GV-MFD120</b> <b>GV-MFD130</b>	<b>Main Stream</b>	<b>4:3</b>	1280 x 960, 640 x 480, 320 x 240
		<b>16:9</b>	1280 x 720, 640 x 360, 448 x 252
		<b>5:4</b>	1280 x 1024, 640 x 512, 320 x 256
<b>GV-MFD120</b> <b>GV-MFD130</b>	<b>Sub Stream</b>	<b>4:3</b>	640 x 480, 320 x 240
		<b>16:9</b>	640 x 360, 448 x 252
		<b>5:4</b>	640 x 512, 320 x 256
<b>GV-MFD220</b>	<b>Main Stream</b>	<b>4:3</b>	1600 x 1200, 1280 x 960, 640 x 480, 320 x 240
		<b>16:9</b>	1920 x 1080, 1280 x 720, 640 x 360, 448 x 252
		<b>5:4</b>	1280 x 1024, 640 x 512, 320 x 256
	<b>Sub Stream</b>	<b>4:3</b>	640 x 480, 320 x 240
		<b>16:9</b>	640 x 360, 448 x 252
		<b>5:4</b>	640 x 512, 320 x 256
<b>GV-MFD320</b>	<b>Main Stream</b>	<b>4:3</b>	2048 x 1536, 1600 x 1200, 1280 x 960, 640 x 480, 320 x 240
		<b>16:9</b>	1920 x 1080, 1280 x 720, 640 x 360, 448 x 252
		<b>5:4</b>	1280 x 1024, 640 x 512, 320 x 256
	<b>Sub Stream</b>	<b>4:3</b>	640 x 480, 320 x 240
		<b>16:9</b>	640 x 360, 448 x 252
		<b>5:4</b>	640 x 512, 320 x 256
<b>GV-MFD520</b>	<b>Main Stream</b>	<b>4:3</b>	2560 x 1920, 2048 x 1536, 1600 x 1200, 1280 x 960, 640 x 480, 320 x 240
		<b>16:9</b>	1920 x 1080, 1280 x 720, 640 x 360, 448 x 252
		<b>5:4</b>	1280 x 1024, 640 x 512, 320 x 256
	<b>Sub Stream</b>	<b>4:3</b>	640 x 480, 320 x 240
		<b>16:9</b>	640 x 360, 448 x 252
		<b>5:4</b>	640 x 512, 320 x 256

## Network

<b>Interface</b>	10/100 Ethernet
<b>Protocol</b>	DHCP, DynDNS, FTP, HTTP, HTTPS, NTP, ONVIF (Profile S), PSIA, QoS (DSCP), RTSP, SNMP, SMTP, TCP, UDP, UPnP, 3GPP/ISMA

## Mechanical

<b>Camera Angle Adjustment</b>	<b>Pan</b>	-45° ~ 45°	
	<b>Tilt</b>	0° ~ 90°	
<b>Temperature Detector</b>		Yes	
<b>Connectors</b>	<b>Power</b>	GV-MFD120 GV-MFD130 GV-MFD220 GV-MFD320 GV-MFD520	PoE, 2-pin terminal block
	<b>Ethernet</b>	Ethernet (10/100 Base-T), RJ-45 cable	
	<b>Audio</b>	GV-MFD120 GV-MFD130 GV-MFD220 GV-MFD320 GV-MFD520	1 In (Built-in microphone)
	<b>Local Storage</b>		Micro SD card slot (SD/SDHC, version 2.0 only, Class 10)
<b>LED Indicator</b>		4 LEDs: Link, ACT, Power, Status	
<b>Note:</b> SDXC and UHS-I card types are not supported.			

## Specifications: Mini Fixed Dome (Part 1)

### General

<b>Environment Temperature</b>		0°C ~ 50°C (32°F ~ 122°F)
<b>Humidity</b>		10% - 90% (no condensation)
<b>Power Source</b>	GV-MFD120 GV-MFD130 GV-MFD220 GV-MFD320	PoE, DC 12V
<b>Max. Power Consumption</b>	GV-MFD120	4.5 W
	GV-MFD130 GV-MFD220 GV-MFD320	5.5 W
	GV-MFD520	6 W
<b>Dimensions</b>	<b>Camera Body</b>	ø106 x 55.6 mm (4.2" x 2.2")
	<b>Cable Length</b>	1 m (3.28 ft)
	<b>Cable Diameter</b>	ø8 mm (0.31")
	<b>Max. Connector Diameter</b>	ø 28.5 mm (1.12")
<b>Weight</b>	GV-MFD120	275 g (0.61 lb)
	GV-MFD130 GV-MFD220 GV-MFD320 GV-MFD520	280 g (0.62 lb)
<b>Regulatory</b>		CE, FCC, C-Tick, UL, RoHS compliant

### Power over Ethernet

<b>PoE Standard</b>	IEEE 802.3af Power over Ethernet / PD
<b>PoE Power Supply Type</b>	End-Span and Mid-Span
<b>PoE Power Output</b>	Per Port 48V DC, 350 mA. Max. 15.4 watts

## Web Interface

<b>Installation Management</b>	Web-based configuration
<b>Maintenance</b>	Firmware upgrade through Web Browser or Utility
<b>Access from Web Browser</b>	Camera live view, video recording, change video quality, bandwidth control, image snapshot, audio, Picture in Picture, Picture and Picture, Privacy Mask, Text Overlay, Digital PTZ
<b>Language</b>	Arabic / Bulgarian / Czech / Danish / Dutch / English / Finnish / French / German / Greek / Hebrew / Hungarian / Indonesian / Italian / Japanese / Lithuanian / Norwegian / Persian / Polish / Portuguese / Romanian / Russian / Serbian / Simplified Chinese / Slovakian / Slovenian / Spanish / Swedish / Thai / Traditional Chinese / Turkish

## Applications

<b>Network Storage</b>	GV-NVR, GV-System, GV-Backup Center, GV-Recording Server
<b>Smart Device Access</b>	GV-Eye for Android smartphone, tablet, iPhone, and iPod Touch; GV-Eye HD for iPad
<b>Live Viewing</b>	IE, mobile phone
<b>CMS Server support</b>	GV-Control Center, GV-Center V2, GV-VSM

All specifications are subject to change without notice.

# Specifications: Mini Fixed Dome

## (Part 2)

This section details the specifications on **GV-MFD1501 series / 2401 series / 2501 series / 3401 series / 5301 series**.

### Camera

Image Sensor	GV-MFD1501 Series	1/3" progressive scan super low lux CMOS	
	GV-MFD2501 Series	1/2.8" progressive scan super low lux CMOS	
	GV-MFD2401 Series GV-MFD3401 Series	1/3.2" progressive scan CMOS	
	GV-MFD5301 Series	1/2.5" progressive scan CMOS	
	Picture Elements	GV-MFD1501 Series	1280 (H) x 1024 (V)
GV-MFD2401 Series GV-MFD2501 Series		1920 (H) x 1080 (V)	
GV-MFD3401 Series		2048 (H) x 1536 (V)	
GV-MFD5301 Series		2560 (H) x 1920 (V)	
Minimum Illumination	GV-MFD1501 Series	Color	0.01 Lux
		B/W	0.01 Lux
	GV-MFD2501 Series	Color	0.02 Lux
		B/W	0.02 Lux
	GV-MFD2401 Series GV-MFD3401 Series	Color	0.08 Lux
		B/W	0.05 Lux
	GV-MFD5301 Series	Color	0.15 Lux
		B/W	0.10 Lux

<b>Shutter Speed</b>		Automatic, Manual (1/5 ~ 1/8000 sec)
<b>White Balance</b>		Automatic, Manual (2800K ~ 8500K)
<b>Gain Control</b>		Automatic
<b>S/N Ratio</b>	GV-MFD1501 Series GV-MFD2401 Series GV-MFD3401 Series GV-MFD5301 Series	55 dB
	GV-MFD2501 Series	52 dB
<b>WDR Pro</b>	GV-MFD2401 Series GV-MFD3401 Series	Yes
<b>WDR</b>		Yes

## Lens

<b>Megapixel</b>		Yes
<b>Day/Night</b>		Yes (electronic)
<b>Lens Type</b>		Fixed
<b>Focal Length</b>	GV-MFD1501-0F GV-MFD2401-0F GV-MFD2501-0F GV-MFD3401-0F GV-MFD5301-0F	2.8 mm
	GV-MFD1501-1F GV-MFD2401-1F GV-MFD2501-1F GV-MFD3401-1F GV-MFD5301-1F	4 mm

## Specifications: Mini Fixed Dome (Part 2)

<b>Focal Length</b>	GV-MFD1501-2F GV-MFD2401-2F GV-MFD2501-2F GV-MFD3401-2F GV-MFD5301-2F	8 mm
	GV-MFD1501-3F GV-MFD2401-3F GV-MFD2501-3F GV-MFD3401-3F GV-MFD5301-3F	12 mm
	GV-MFD1501-4F GV-MFD2401-4F GV-MFD2501-4F GV-MFD3401-4F	2.1 mm
<b>Maximum Aperture</b>	GV-MFD1501-0F GV-MFD2401-0F GV-MFD2501-0F GV-MFD3401-0F GV-MFD5301-0F	F/2.0
	GV-MFD1501-1F GV-MFD2401-1F GV-MFD2501-1F GV-MFD3401-1F GV-MFD5301-1F	F/1.5



<b>Maximum Aperture</b>	GV-MFD1501-2F GV-MFD1501-3F GV-MFD2401-2F GV-MFD2401-3F GV-MFD2501-2F GV-MFD2501-3F GV-MFD3401-2F GV-MFD3401-3F GV-MFD5301-2F GV-MFD5301-3F	F/1.6
	GV-MFD1501-4F GV-MFD2401-4F GV-MFD2501-4F GV-MFD3401-4F	F/1.8
<b>Mount</b>		M12, Pitch 0.5 mm
<b>Image Format</b>		1/3"
<b>Horizontal FOV</b>	GV-MFD1501-0F	87°
	GV-MFD2401-0F	79°
	GV-MFD2501-0F	99°
	GV-MFD3401-0F	80°
	GV-MFD5301-0F	103°
	GV-MFD1501-1F	67°
	GV-MFD2401-1F	58°
	GV-MFD2501-1F	72°
	GV-MFD3401-1F	62°
	GV-MFD5301-1F	84°
	GV-MFD1501-2F	35°
	GV-MFD2401-2F	31°

## Specifications: Mini Fixed Dome (Part 2)

<b>Horizontal FOV</b>	<b>GV-MFD2501-2F</b>	38°
	<b>GV-MFD3401-2F</b>	33°
	<b>GV-MFD5301-2F</b>	41°
	<b>GV-MFD1501-3F</b>	22°
	<b>GV-MFD2401-3F</b>	20°
	<b>GV-MFD2501-3F</b>	25°
	<b>GV-MFD3401-3F</b>	21°
	<b>GV-MFD5301-3F</b>	26°
	<b>GV-MFD1501-4F</b>	124°
	<b>GV-MFD2401-4F</b>	112°
	<b>GV-MFD2501-4F</b>	150°
	<b>GV-MFD3401-4F</b>	120°
<b>Operation (Focus / Zoom / Iris)</b>		Fixed
<b>Note:</b> The day/night function is only supported by V1.07 or later.		

### Operation

<b>Video Compression</b>		H.264, MJPEG
<b>Video Stream</b>		Dual streams from H.264 or MJPEG
<b>Frame Rate</b>	<b>GV-MFD1501 Series</b>	30 fps at 1280 x 1024
	<b>GV-MFD2401 Series GV-MFD2501 Series</b>	30 fps at 1920 x 1080
	<b>GV-MFD3401 Series</b>	20 fps at 2048 x 1536
	<b>GV-MFD5301 Series</b>	10 fps at 2560 x 1920

<b>Image Setting</b>	Brightness, Contrast, Saturation, Sharpness, Gamma, White Balance, Flicker-less 50/60 Hz, Image Orientation, Shutter Speed, Backlight Compensation, D/N sensitivity, WDR, Defog, Super Low Lux
<b>Audio Compression</b>	G.711, AAC (Optional)
<b>Audio Support</b>	Two-Way Audio
<b>Sensor Input</b>	No
<b>Alarm Output</b>	No
<b>Note:</b>	
<ol style="list-style-type: none"> <li>The frame rate and performance may vary depending on the number of connections and data bitrates (different scenes).</li> <li>The Super Low Lux adjustment (Image Settings) is only available for GV-MFD1501 Series / 2501 Series.</li> </ol>	

## Video Resolution

<b>GV-MFD1501 Series</b>	<b>Main Stream</b>	<b>4:3</b>	1280 x 960, 640 x 480, 320 x 240
		<b>16:9</b>	1280 x 720, 640 x 360, 448 x 252
		<b>5:4</b>	1280 x 1024, 640 x 512, 320 x 256
	<b>Sub Stream</b>	<b>4:3</b>	640 x 480, 320 x 240
		<b>16:9</b>	640 x 360, 448 x 252
		<b>5:4</b>	640 x 512, 320 x 256
<b>GV-MFD2401 Series GV-MFD2501 Series</b>	<b>Main Stream</b>	<b>4:3</b>	1600 x 1200, 1280 x 960, 640 x 480, 320 x 240
		<b>16:9</b>	1920 x 1080, 1280 x 720, 640 x 360, 448 x 252
		<b>5:4</b>	1280 x 1024, 640 x 512, 320 x 256
	<b>Sub Stream</b>	<b>4:3</b>	640 x 480, 320 x 240
		<b>16:9</b>	640 x 360, 448 x 252
		<b>5:4</b>	640 x 512, 320 x 256

## Specifications: Mini Fixed Dome (Part 2)

<b>GV-MFD3401 Series</b>	<b>Main Stream</b>	<b>4:3</b>	2048 x 1536, 1600 x 1200, 1280 x 960, 640 x 480, 320 x 240
		<b>16:9</b>	1920 x 1080, 1280 x 720, 640 x 360, 448 x 252
		<b>5:4</b>	1280 x 1024, 640 x 512, 320 x 256
	<b>Sub Stream</b>	<b>4:3</b>	640 x 480, 320 x 240
		<b>16:9</b>	640 x 360, 448 x 252
		<b>5:4</b>	640 x 512, 320 x 256
<b>GV-MFD5301 Series</b>	<b>Main Stream</b>	<b>4:3</b>	2560 x 1920, 2048 x 1536, 1600 x 1200, 1280 x 960, 640 x 480, 320 x 240
		<b>16:9</b>	1920 x 1080, 1280 x 720, 640 x 360, 448 x 252
		<b>5:4</b>	1280 x 1024, 640 x 512, 320 x 256
	<b>Sub Stream</b>	<b>4:3</b>	640 x 480, 320 x 240
		<b>16:9</b>	640 x 360, 448 x 252
		<b>5:4</b>	640 x 512, 320 x 256

### Network

<b>Interface</b>	10/100 Ethernet
<b>Protocol</b>	DHCP, DynDNS, FTP, HTTP, HTTPS, NTP, ONVIF (Profile S), PSIA, QoS (DSCP), RTSP, SNMP, SMTP, TCP, UDP, UPnP, 3GPP/ISMA

### Mechanical

<b>Camera Angle Adjustment</b>	<b>Pan</b>	-45° ~ 45°
	<b>Tilt</b>	0° ~ 90°

<b>Temperature Detector</b>		Yes
<b>Connectors</b>	<b>Power</b>	PoE, 2-pin terminal block
	<b>Ethernet</b>	Ethernet (10/100 Base-T), RJ-45 cable
	<b>Audio</b>	1 In (Built-in microphone) 1 Out (RCA female for speaker)
	<b>USB</b>	GV-WiFi adapter or USB hard drive
	<b>Local Storage</b>	Micro SD card slot (SD/SDHC, version 2.0 only, Class 10)
<b>LED Indicator</b>	4 LEDs: Link, ACT, Power, Status	
<b>Note:</b>		
<ol style="list-style-type: none"> <li>Mind the following limitations and requirements for the USB port: <ul style="list-style-type: none"> <li>The USB hard drive must be of 2.5" or 3.5", version 2.0 or above</li> <li>The USB hard drive's storage capacity must not exceed 2TB</li> <li>USB flash drives and USB hubs are not supported</li> <li>External power supply is required for the USB hard drive</li> <li>To connect a GV-WiFi Adapter, make sure it is connected before the camera is powered on.</li> </ul> </li> <li>SDXC and UHS-I card types are not supported.</li> </ol>		

## General

<b>Camera Housing</b>	black, white
<b>Environment Temperature</b>	0°C ~ 50°C (32°F ~ 122°F)
<b>Humidity</b>	10% - 90% (no condensation)
<b>Power Source</b>	PoE, DC 5V
<b>Max. Power Consumption</b>	6 W
<b>Dimensions</b>	ø106 x 53.9 mm (4.2" x 2.1")
<b>Weight</b>	280 g (0.62 lb)
<b>Regulatory</b>	CE, FCC, C-Tick, RoHS compliant

## Specifications: Mini Fixed Dome (Part 2)

### Power over Ethernet

<b>PoE Standard</b>	IEEE 802.3af Power over Ethernet / PD
<b>PoE Power Supply Type</b>	End-Span
<b>PoE Power Output</b>	Per Port 48V DC, 350 mA. Max. 15.4 watts

### Web Interface

<b>Installation Management</b>	Web-based configuration
<b>Maintenance</b>	Firmware upgrade through Web Browser or Utility
<b>Access from Web Browser</b>	Camera live view, video recording, change video quality, bandwidth control, image snapshot, audio, Picture in Picture, Picture and Picture, Privacy Mask, Text Overlay, Digital PTZ
<b>Language</b>	Arabic / Bulgarian / Czech / Danish / Dutch / English / Finnish / French / German / Greek / Hebrew / Hungarian / Indonesian / Italian / Japanese / Lithuanian / Norwegian / Persian / Polish / Portuguese / Romanian / Russian / Serbian / Simplified Chinese / Slovakian / Slovenian / Spanish / Swedish / Thai / Traditional Chinese / Turkish

### Applications

<b>Network Storage</b>	GV-NVR, GV-System, GV-Backup Center, GV-Recording Server
<b>Smart Device Access</b>	GV-Eye for Android smartphone, tablet, iPhone, and iPod Touch; GV-Eye HD for iPad
<b>Live Viewing</b>	IE, mobile phone
<b>CMS Server support</b>	GV-Control Center, GV-Center V2, GV-VSM

All specifications are subject to change without notice.

# Specifications: Mini Fixed Rugged

## Dome

### Camera

Image Sensor	<b>GV-MDR120</b>	1/3" progressive scan low lux CMOS
	<b>GV-MDR1500 Series</b>	1/3" progressive scan super low lux CMOS
	<b>GV-MDR220</b> <b>GV-MDR320</b> <b>GV-MDR520</b> <b>GV-MDR5300 Series</b>	1/2.5" progressive scan CMOS
	<b>GV-MDR2400 Series</b> <b>GV-MDR3400 Series</b>	1/3.2" progressive scan CMOS
	<b>GV-MDR2500 Series</b>	1/2.8" progressive scan super low lux CMOS
	Picture Elements	<b>GV-MDR120</b> <b>GV-MDR1500 Series</b>
<b>GV-MDR220</b> <b>GV-MDR2400 Series</b> <b>GV-MDR2500 Series</b>		1920 (H) x 1080 (V)
<b>GV-MDR320</b> <b>GV-MDR3400 Series</b>		2048 (H) x 1536 (V)
<b>GV-MDR520</b> <b>GV-MDR5300 Series</b>		2560 (H) x 1920 (V)

## Specifications: Mini Fixed Rugged Dome

<b>Minimum Illumination</b>	GV-MDR120	<b>Color</b>	0.05 Lux	
		<b>B/W</b>	0.03 Lux	
	GV-MDR220 GV-MDR320 GV-MDR520	<b>Color</b>	0.15 Lux	
		<b>B/W</b>	0.10 Lux	
	GV-MDR1500 Series	<b>Color</b>	0.01 Lux	
		<b>B/W</b>		
	GV-MDR2400 Series GV-MDR3400 Series	<b>Color</b>	0.08 Lux	
		<b>B/W</b>	0.05 Lux	
	GV-MDR2500 Series	<b>Color</b>	0.02 Lux	
		<b>B/W</b>		
	GV-MDR5300 Series	<b>Color</b>	0.15 Lux	
		<b>B/W</b>	0.10 Lux	
<b>Shutter Speed</b>		Automatic, Manual (1/5 ~ 1/8000 sec)		
<b>White Balance</b>		Automatic, Manual (2800K ~ 8500K)		
<b>Gain Control</b>		Automatic		
<b>S/N Ratio</b>	GV-MDR120	50 dB		
	GV-MDR220 GV-MDR320 GV-MDR520 GV-MDR5300 Series	45 dB		
	GV-MDR1500 Series	55 dB		
	GV-MDR2400 Series GV-MDR3400 Series	47 dB		
	GV-MDR2500 Series	52 dB		
	<b>WDR Pro</b>		GV-MDR2400 Series GV-MDR3400 Series Yes (with WDR sensor)	



<b>WDR</b>	Yes
------------	-----

## Lens

<b>Megapixel</b>		Yes
<b>Day/Night</b>		Yes (electronic)
<b>Lens Type</b>		Fixed
<b>Focal Length</b>	<b>GV-MDR120</b>	4 mm
	<b>GV-MDR220</b> <b>GV-MDR320</b> <b>GV-MDR520</b>	2.54 mm
	<b>GV-MDR1500-0F</b> <b>GV-MDR2400-0F</b> <b>GV-MDR2500-0F</b> <b>GV-MDR3400-0F</b>	2.1 mm
	<b>GV-MDR1500-1F</b> <b>GV-MDR2400-1F</b> <b>GV-MDR2500-1F</b> <b>GV-MDR3400-1F</b> <b>GV-MDR5300-1F</b>	2.8 mm
	<b>GV-MDR1500-2F</b> <b>GV-MDR2400-2F</b> <b>GV-MDR2500-2F</b> <b>GV-MDR3400-2F</b> <b>GV-MDR5300-2F</b>	3.8 mm
	<b>GV-MDR1500-3F</b> <b>GV-MDR2400-3F</b> <b>GV-MDR2500-3F</b> <b>GV-MDR3400-3F</b> <b>GV-MDR5300-3F</b>	8 mm

## Specifications: Mini Fixed Rugged Dome

<b>Focal Length</b>	GV-MDR1500-4F GV-MDR2400-4F GV-MDR2500-4F GV-MDR3400-4F GV-MDR5300-4F	12 mm
<b>Maximum Aperture</b>	GV-MDR120	F/1.5
	GV-MDR220 GV-MDR320 GV-MDR520	F/2.8
	GV-MDR1500-0F GV-MDR2400-0F GV-MDR2500-0F GV-MDR3400-0F GV-MDR1500-2F GV-MDR2400-2F GV-MDR2500-2F GV-MDR3400-2F GV-MDR5300-2F	F/1.8
	GV-MDR1500-1F GV-MDR2400-1F GV-MDR2500-1F GV-MDR3400-1F GV-MDR5300-1F	F/2.0

<b>Maximum Aperture</b>	GV-MDR1500-3F GV-MDR2400-3F GV-MDR2500-3F GV-MDR3400-3F GV-MDR5300-3F GV-MDR1500-4F GV-MDR2400-4F GV-MDR2500-4F GV-MDR3400-4F GV-MDR5300-4F		F/1.6
	<b>Mount</b>		M12, Pitch 0.5 mm
<b>Image Format</b>	GV-MDR120 GV-MDR1500 Series GV-MDR2400 Series GV-MDR2500 Series GV-MDR3400 Series GV-MDR5300 Series		1/3"
	GV-MDR220 GV-MDR320 GV-MDR520		1/2.5"
<b>Horizontal FOV</b>	GV-MDR120		70°
	GV-MDR220		101°
	GV-MDR320		110°
	GV-MDR520		138°
	GV-MDR1500	-0F	126°
		-1F	88°
		-2F	64°
		-3F	34°
		-4F	22°
GV-MDR2400	-0F	113°	

## Specifications: Mini Fixed Rugged Dome

Horizontal FOV	GV-MDR2400	-1F	80°
		-2F	60°
		-3F	30°
		-4F	20°
	GV-MDR2500	-0F	135°
		-1F	98°
		-2F	72°
		-3F	38°
		-4F	25°
	GV-MDR3400	-0F	121°
		-1F	85°
		-2F	63°
		-3F	32°
		-4F	21°
	GV-MDR5300	-1F	104°
		-2F	76°
-3F		41°	
-4F		27°	
Operation (Focus / Zoom / Iris)			Fixed

## Operation

Video Compression		H.264, MJPEG
Video Stream		Dual streams from H.264 or MJPEG
Frame Rate	GV-MDR120 GV-MDR1500 Series	30 fps at 1280 x 1024
	GV-MDR220 GV-MDR2400 Series GV-MDR2500 Series	30 fps at 1920 x 1080

Frame Rate	GV-MDR320 GV-MDR3400 Series	20 fps at 2048 x 1536
	GV-MDR520 GV-MDR5300 Series	10 fps at 2560 x 1920
Image Setting	Brightness, Contrast, Saturation, Sharpness, Gamma, White Balance, Flicker-less 50/60 Hz, Image Orientation, Shutter Speed, Backlight Compensation, D/N sensitivity, WDR, Defog, Super Low Lux	
Audio Compression	G.711, AAC (Optional)	
Audio Support	One-Way Audio	
Sensor Input	No	
Alarm Output	No	
<b>Note:</b> <ol style="list-style-type: none"> <li>The frame rate and performance may vary depending on the number of connections and data bitrates (different scenes).</li> <li>The super low lux setting is only available in GV-MDR1500 series and GV-MDR2500 series.</li> </ol>		

## Video Resolution

GV-MDR120 GV-MDR1500 Series	Main Stream	4:3	1280 x 960, 640 x 480, 320 x 240
		16:9	1280 x 720, 640 x 360, 448 x 252
		5:4	1280 x 1024, 640 x 512, 320 x 256
	Sub Stream	4:3	640 x 480, 320 x 240
		16:9	640 x 360, 448 x 252
		5:4	640 x 512, 320 x 256
GV-MDR220 GV-MDR2400 Series GV-MDR2500 Series	Main Stream	4:3	1600 x 1200, 1280 x 960, 640 x 480, 320 x 240
		16:9	1920 x 1080, 1280 x 720, 640 x 360, 448 x 252
		5:4	1280 x 1024, 640 x 512, 320 x 256

## Specifications: Mini Fixed Rugged Dome

GV-MDR220 GV-MDR2400 Series GV-MDR2500 Series	Sub Stream	4:3	640 x 480, 320 x 240
		16:9	640 x 360, 448 x 252
		5:4	640 x 512, 320 x 256
GV-MDR320 GV-MDR3400 Series	Main Stream	4:3	2048 x 1536, 1600 x 1200, 1280 x 960, 640 x 480, 320 x 240
		16:9	1920 x 1080, 1280 x 720, 640 x 360, 448 x 252
		5:4	1280 x 1024, 640 x 512, 320 x 256
	Sub Stream	4:3	640 x 480, 320 x 240
		16:9	640 x 360, 448 x 252
		5:4	640 x 512, 320 x 256
GV-MDR520 GV-MDR5300 Series	Main Stream	4:3	2560 x 1920, 2048 x 1536, 1600 x 1200, 1280 x 960, 640 x 480, 320 x 240
		16:9	1920 x 1080, 1280 x 720, 640 x 360, 448 x 252
		5:4	1280 x 1024, 640 x 512, 320 x 256
	Sub Stream	4:3	640 x 480, 320 x 240
		16:9	640 x 360, 448 x 252
		5:4	640 x 512, 320 x 256

## Network

Interface	10/100 Ethernet
Protocol	DHCP, DynDNS, FTP, HTTP, HTTPS, NTP, ONVIF (Profile S), PSIA, QoS (DSCP), RTSP, SNMP, SMTP, TCP, UDP, UPnP, 3GPP/ISMA

## Mechanical

Camera Angle Adjustment	GV-MDR	Pan	-45° ~ 45°
-------------------------	--------	-----	------------

<b>Camera Angle Adjustment</b>	<b>GV-MDR</b>	<b>Tilt</b>	0° ~ 90°
		<b>Rotate</b>	0° ~ 360°
<b>Temperature Detector</b>		Yes	
<b>Connectors</b>	<b>Power</b>	PoE	
	<b>Ethernet</b>	Ethernet (10/100 Base-T), RJ-45 cable	
	<b>Audio</b>	1 In (Built-in microphone)	
	<b>Local Storage</b>	Micro SD card slot (SD/SDHC, version 2.0 only, Class 10)	
<b>LED Indicator</b>	3 LEDs: Link, Power, Status		
<b>Note:</b> SDXC and UHS-I card types are not supported.			

## General

<b>Environment Temperature</b>		-30°C ~ 50°C (-22°F ~ 122°F)
<b>Humidity</b>		10% - 90% (no condensation)
<b>Power Source</b>		PoE
<b>Max. Power Consumption</b>	<b>GV-MDR120</b>	3 W
	<b>GV-MDR220</b>	3.4 W
	<b>GV-MDR320</b>	
	<b>GV-MDR520</b>	3.6 W
	<b>GV-MDR1500 Series</b>	3.47 W
	<b>GV-MDR2400 Series</b>	4.28 W
	<b>GV-MDR3400 Series</b>	
	<b>GV-MDR2500 Series</b>	4.23 W
<b>GV-MDR5300 Series</b>	3.81 W	
<b>Dimensions</b>	<b>Camera Body</b>	ø115 x 59.2 mm (4.5" x 2.3")
	<b>Cable Length</b>	1.054 m (41.5")
	<b>Cable Diameter</b>	ø6.2 mm (0.24")

## Specifications: Mini Fixed Rugged Dome

	Connector Diameter	M12	ø14.7 mm (0.58")
		Waterproof	ø27 mm (1.06")
		Non-waterproof (Smaller)	16.8 x 13.8 mm (0.66" x 0.54")
<b>Weight</b>			568 g (1.3 lb)
<b>Ingress Protection</b>			IP67
<b>Vandal Resistance</b>			IK10 for metal casing
<b>Regulatory</b>	<b>GV-MDR120</b> <b>GV-MDR220</b> <b>GV-MDR320</b> <b>GV-MDR520</b>		CE, FCC, C-Tick, EN50155, RoHS compliant
<b>Regulatory</b>	<b>GV-MDR1500 Series</b> <b>GV-MDR2400 Series</b> <b>GV-MDR2500 Series</b> <b>GV-MDR3400 Series</b> <b>GV-MDR5300 Series</b>		CE, FCC, RCM, EN50155, RoHS compliant

## Power over Ethernet

<b>PoE Standard</b>		IEEE 802.3af Power over Ethernet / PD
<b>PoE Power Supply Type</b>	<b>GV-MDR120</b> <b>GV-MDR220</b> <b>GV-MDR320</b> <b>GV-MDR520</b>	End-Span and Mid-Span
	<b>GV-MDR1500 Series</b> <b>GV-MDR2400 Series</b> <b>GV-MDR2500 Series</b> <b>GV-MDR3400 Series</b> <b>GV-MDR5300 Series</b>	End-Span
<b>PoE Power Output</b>		Per Port 48V DC, 350 mA. Max. 15.4 watts



## Web Interface

<b>Installation Management</b>	Web-based configuration
<b>Maintenance</b>	Firmware upgrade through Web Browser or Utility
<b>Access from Web Browser</b>	Camera live view, video recording, change video quality, bandwidth control, image snapshot, audio, Picture in Picture, Picture and Picture, Privacy Mask, Text Overlay, Digital PTZ
<b>Language</b>	Arabic / Bulgarian / Czech / Danish / Dutch / English / Finnish / French / German / Greek / Hebrew / Hungarian / Indonesian / Italian / Japanese / Lithuanian / Norwegian / Persian /
<b>Language</b>	Polish / Portuguese / Romanian / Russian / Serbian / Simplified Chinese / Slovakian / Slovenian / Spanish / Swedish / Thai / Traditional Chinese / Turkish

## Applications

<b>Network Storage</b>	GV-NVR, GV-System, GV-Backup Center, GV-Recording Server
<b>Smart Device Access</b>	GV-Eye for Android smartphone, tablet, iPhone, and iPod Touch; GV-Eye HD for iPad
<b>Live Viewing</b>	IE, mobile phone
<b>CMS Server support</b>	GV-Control Center, GV-Center V2, GV-VSM

All specifications are subject to change without notice.

# Specifications: Target Mini Fixed Dome

## Camera

<b>Image Sensor</b>	1/3" progressive scan low lux CMOS	
<b>Picture Elements</b>	1280 (H) x 1024 (V)	
<b>Minimum Illumination</b>	<b>Color</b>	0.05 Lux
	<b>B/W</b>	0.03 Lux
	<b>IR ON</b>	0 Lux
<b>Shutter Speed</b>	Automatic, Manual (1/5 ~ 1/8000 sec)	
<b>White Balance</b>	Automatic, Manual (2800K ~ 8500K)	
<b>Gain Control</b>	Automatic	
<b>S/N Ratio</b>	50 dB	
<b>WDR</b>	Yes	

## Lens

<b>Megapixel</b>	Yes	
<b>Day/Night</b>	Yes (with removable IR-cut filter)	
<b>Lens Type</b>	Fixed	
<b>Focal Length</b>	<b>GV-EFD1100-0F</b>	2.8 mm
	<b>GV-EFD1100-1F</b>	3.8 mm
<b>Maximum Aperture</b>	F/1.8	
<b>Mount</b>	M12, Pitch 0.5 mm	
<b>Image Format</b>	1/2.7"	

<b>Horizontal FOV</b>	<b>GV-EFD1100-0F</b>	93°
	<b>GV-EFD1100-1F</b>	64°
<b>Operation (Focus / Zoom / Iris)</b>		Fixed
<b>IR LED Quantity</b>		12 IR LEDs
<b>Max. IR Distance</b>		15 m (50 ft)

## Operation

<b>Video Compression</b>	H.264, MJPEG
<b>Video Stream</b>	Dual streams from H.264 or MJPEG
<b>Frame Rate</b>	30 fps at 1280 x 1024
<b>Image Setting</b>	Brightness, Contrast, Saturation, Sharpness, Gamma, White Balance, Flicker-less, Image Orientation, Shutter Speed, D/N Sensitivity, Backlight Compensation, WDR, Defog
<b>Audio Compression</b>	G.711, AAC (Optional)
<b>Audio Support</b>	One-Way Audio
<b>Note:</b> The frame rate and performance may vary depending on the number of connections and data bitrates (different scenes).	

## Video Resolution

<b>Main Stream</b>	<b>4:3</b>	1280 x 960, 640 x 480, 320 x 240
	<b>16:9</b>	1280 x 720, 640 x 360, 448 x 252
	<b>5:4</b>	1280 x 1024, 640 x 512, 320 x 256
<b>Sub Stream</b>	<b>4:3</b>	640 x 480, 320 x 240
	<b>16:9</b>	640 x 360, 448 x 252
	<b>5:4</b>	640 x 512, 320 x 256

## Specifications: Target Mini Fixed Dome

### Network

<b>Interface</b>	10/100 Ethernet
<b>Protocol</b>	DHCP, DynDNS, FTP, HTTP, HTTPS, NTP, ONVIF (Profile S), QoS (DSCP), RTSP, SNMP, SMTP, TCP, UDP, UPnP, 3GPP/ISMA

### Mechanical

<b>Camera Angle Adjustment</b>	<b>Pan</b>	-45° ~ 45°
	<b>Tilt</b>	0° ~ 55°
<b>Connectors</b>	<b>Power</b>	2-pin terminal block, PoE
	<b>Ethernet</b>	Ethernet (10/100 Base-T), RJ-45 cable
	<b>Audio</b>	1 In (Built-in microphone)
<b>LED Indicator</b>	4 LEDs: Link, ACT, Power, Status	

### General

<b>Environment Temperature</b>	0°C ~ 45°C (32°F ~ 113°F)
<b>Humidity</b>	10% - 90% (no condensation)
<b>Power Source</b>	12V DC/PoE (IEEE 802.3af)
<b>Max. Power Consumption</b>	5.8 W
<b>Dimensions</b>	ø100 x 60 mm (3.9" x 2.4")
<b>Weight</b>	148 g (0.33 lb)
<b>Regulatory</b>	CE, FCC, C-Tick, RCM, RoHS compliant

### Power over Ethernet

<b>PoE Standard</b>	IEEE 802.3af Power over Ethernet / PD
<b>PoE Power Supply Type</b>	End-Span

<b>PoE Power Output</b>	Per Port 48V DC, 350 mA. Max. 15.4 watts
-------------------------	--

## Web Interface

<b>Installation Management</b>	Web-based configuration
<b>Maintenance</b>	Firmware upgrade through Web Browser or Utility
<b>Access from Web Browser</b>	Camera Live View, Video Recording, Change Video Quality, Bandwidth Control, Image Snapshot, Audio, Picture in Picture, Picture and Picture, Privacy Mask, Text Overlay, Digital PTZ
<b>Language</b>	Arabic / Bulgarian / Czech / Danish / Dutch / English / Finnish / French / German / Greek / Hebrew / Hungarian / Indonesian / Italian / Japanese / Lithuanian / Norwegian / Persian / Polish / Portuguese / Romanian / Russian / Serbian / Simplified Chinese / Slovakian / Slovenian / Spanish / Swedish / Thai / Traditional Chinese / Turkish

## Applications

<b>Network Storage</b>	GV-NVR, GV-System, GV-Recording Server
<b>Smart Device Access</b>	GV-Eye for Android smartphone, tablet, iPhone, and iPod Touch; GV-Eye HD for iPad
<b>Live Viewing</b>	IE, mobile phone
<b>CMS Server support</b>	GV-Control Center, GV-Center V2, GV-VSM

All specifications are subject to change without notice.

# Specifications: Bullet Camera

## (Part 1)

This section details the specifications on **GV-BL120D / 130D / 220D / 320D** and **GV-BL1200 / 1300 / 1500 / 2400 / 2500 / 3400**.

### Camera

Image Sensor	GV-BL120D GV-BL1200	1/3" progressive scan low lux CMOS
	GV-BL130D GV-BL220D GV-BL320D GV-BL1300	1/2.5" progressive scan CMOS
	GV-BL1500	1/3" progressive scan super low lux CMOS
	GV-BL2500	1/2.8" progressive scan super low lux CMOS
	GV-BL2400 GV-BL3400	1/3.2" progressive scan CMOS
Picture Elements	GV-BL120D GV-BL130D GV-BL1200 GV-BL1300 GV-BL1500	1280 (H) x 1024 (V)
	GV-BL220D GV-BL2400 GV-BL2500	1920 (H) x 1080 (V)

<b>Picture Elements</b>	<b>GV-BL320D</b> <b>GV-BL3400</b>		2048 (H) x 1536 (V)
<b>Minimum Illumination</b>	<b>GV-BL120D</b> <b>GV-BL1200</b>	<b>Color</b>	0.05 Lux
		<b>B/W</b>	0.03 Lux
		<b>IR ON</b>	0 Lux
	<b>GV-BL130D</b> <b>GV-BL220D</b> <b>GV-BL320D</b> <b>GV-BL1300</b>	<b>Color</b>	0.15 Lux
		<b>B/W</b>	0.10 Lux
		<b>IR On</b>	0 Lux
	<b>GV-BL1500</b>	<b>Color</b>	0.01 Lux
		<b>B/W</b>	0.01 Lux
		<b>IR On</b>	0 Lux
	<b>GV-BL2500</b>	<b>Color</b>	0.02 Lux
		<b>B/W</b>	0.02 Lux
		<b>IR On</b>	0 Lux
	<b>GV-BL2400</b> <b>GV-BL3400</b>	<b>Color</b>	0.08 Lux
		<b>B/W</b>	0.05 Lux
		<b>IR On</b>	0 Lux
<b>Shutter Speed</b>		Automatic, Manual (1/5 ~ 1/8000 sec)	
<b>White Balance</b>		Automatic, Manual (2800K ~ 8500K)	
<b>Gain Control</b>		Automatic	
<b>S/N Ratio</b>	<b>GV-BL120D</b> <b>GV-BL1200</b>	50 dB	

## Specifications: Bullet Camera (Part 1)

S/N Ratio	GV-BL130D GV-BL220D GV-BL320D GV-BL1300	45 dB
	GV-BL1500	55 dB
	GV-BL2500	52 dB
	GV-BL2400 GV-BL3400	47 dB
	GV-BL2400 GV-BL3400	Yes (with WDR sensor)
WDR Pro	GV-BL2400 GV-BL3400	Yes (with WDR sensor)
WDR		Yes

### Lens

Megapixel	Yes	
Day / Night	Yes (with removable IR-cut filter)	
Lens Type	Varifocal	
Focal Length	3 ~ 9 mm	
Maximum Aperture	F/1.2	
Mount	∅ 14 mm	
Image Format	1/2.7"	
Horizontal FOV	GV-BL1200	86° ~ 32°
	GV-BL1300	60° ~ 23°
	GV-BL1500	90° ~ 32°
	GV-BL2400	82° ~ 30°
	GV-BL2500	103° ~ 36°
	GV-BL3400	86° ~ 31°
Operation	Focus	Manual (w/lock)



<b>Operation</b>	<b>Zoom</b>	Manual (w/lock)	
	<b>Iris</b>	DC drive	
<b>IR LED Quantity</b>		16 IR LEDs	
<b>Max. IR Distance</b>	<b>GV-BL120D</b> <b>GV-BL220D</b> <b>GV-BL320D</b>	15 m (50 ft)	
	<b>GV-BL1200</b> <b>GV-BL1300</b>	40m (131 ft)	
	<b>GV-BL1500</b>	70m (230 ft)	
	<b>GV-BL2400</b> <b>GV-BL2500</b> <b>GV-BL3400</b>	50 m (164 ft)	
	<b>Max. Torque (Zoom/Focus Screws)</b>		0.049 N.m

## Operation

<b>Video Compression</b>		H.264, MJPEG
<b>Video Stream</b>		Dual streams from H.264 or MJPEG
<b>Frame Rate</b>	<b>GV-BL120D</b> <b>GV-BL130D</b> <b>GV-BL1200</b> <b>GV-BL1300</b> <b>GV-BL1500</b>	30 fps at 1280 x 1024
	<b>GV-BL220D</b> <b>GV-BL2400</b> <b>GV-BL2500</b>	30 fps at 1920 x 1080

## Specifications: Bullet Camera (Part 1)

<b>Frame Rate</b>	<b>GV-BL320D</b> <b>GV-BL3400</b>	20 fps at 2048 x 1536
<b>Image Setting</b>	Brightness, Contrast, Saturation, Sharpness, Gamma, White Balance, Flicker-less, Image Orientation, Shutter Speed, D/N Sensitivity, Backlight Compensation, WDR, Defog, Super Low Lux	
<b>Audio Compression</b>	G.711, AAC (Optional)	
<b>Audio Support</b>	Two-Way Audio	
<b>Sensor Input</b>	1 Input (Dry Contact)	
<b>Alarm Output</b>	1 Output (200mA 5V DC)	
<b>Note:</b>		
<ol style="list-style-type: none"> <li>The frame rate and performance may vary depending on the number of connections and data bitrates (different scenes).</li> <li>The Super Low Lux function (Image Settings) is only available for GV-BL1500/2500.</li> </ol>		

## Video Resolution

<b>GV-BL120D</b> <b>GV-BL1200</b> <b>GV-BL130D</b>	<b>Main Stream</b>	<b>4:3</b>	1280 x 960, 640 x 480, 320 x 240
		<b>16:9</b>	1280 x 720, 640 x 360, 448 x 252
		<b>5:4</b>	1280 x 1024, 640 x 512, 320 x 256
<b>GV-BL1300</b> <b>GV-BL1500</b>	<b>Sub Stream</b>	<b>4:3</b>	640 x 480, 320 x 240
		<b>16:9</b>	640 x 360, 448 x 252
		<b>5:4</b>	640 x 512, 320 x 256

<b>GV-BL220D</b> <b>GV-BL2400</b> <b>GV-BL2500</b>	<b>Main Stream</b>	<b>4:3</b>	1600 x 1200, 1280 x 960, 640 x 480, 320 x 240
		<b>16:9</b>	1920 x 1080, 1280 x 720, 640 x 360, 448 x 252
		<b>5:4</b>	1280 x 1024, 640 x 512, 320 x 256
	<b>Sub Stream</b>	<b>4:3</b>	640 x 480, 320 x 240
		<b>16:9</b>	640 x 360, 448 x 252
		<b>5:4</b>	640 x 512, 320 x 256
<b>GV-BL320D</b> <b>GV-BL3400</b>	<b>Main Stream</b>	<b>4:3</b>	2048 x 1536, 1600 x 1200, 1280 x 960, 640 x 480, 320 x 240
		<b>16:9</b>	1920 x 1080, 1280 x 720, 640 x 360, 448 x 252
	<b>Sub Stream</b>	<b>5:4</b>	1280 x 1024, 640 x 512, 320 x 256
		<b>4:3</b>	640 x 480, 320 x 240
		<b>16:9</b>	640 x 360, 448 x 252
		<b>5:4</b>	640 x 512, 320 x 256

## Network

<b>Interface</b>	10/100 Ethernet
<b>Protocol</b>	DHCP, DynDNS, FTP, HTTP, HTTPS, NTP, ONVIF (Profile S), PSIA, QoS (DSCP), RTSP, SNMP, SMTP, TCP, UDP, UPnP, 3GPP/ISMA

## Specifications: Bullet Camera (Part 1)

### Mechanical

<b>Camera Angle Adjustment</b>	<b>Pan</b>	0° ~ 360°
	<b>Tilt</b>	90° ~ 180°
	<b>Rotate</b>	0° ~ 360°
<b>Temperature Detector</b>		Yes
<b>Connectors</b>	<b>Power</b>	2-pin terminal block, PoE
	<b>Ethernet</b>	Ethernet (10/100 Base-T), RJ-45 cable
	<b>Audio</b>	1 In (Brown terminal block or RCA female for microphone); 1 Out (Green terminal block or RCA female for speaker)
	<b>Digital I/O</b>	I/O Wire
	<b>Local Storage</b>	Micro SD card slot (SD/SDHC, version 2.0 only, Class 10)
	<b>TV-Out</b>	No
<b>Note:</b> SDXC and UHS-I card types are not supported.		

### General

<b>Environment Temperature</b>	GV-BL120D GV-BL130D GV-BL220D GV-BL320D	-20°C ~ 50°C (-4°F ~ 122°F)
	GV-BL1200 GV-BL1300 GV-BL1500 GV-BL2400 GV-BL2500 GV-BL3400	-30°C ~ 50°C (-22°F ~ 122°F)

<b>Humidity</b>		10% to 90% (no condensation)
<b>Power Source</b>		12V DC / 24V AC / PoE
<b>Max. Power Consumption</b>	GV-BL120D GV-BL130D GV-BL220D GV-BL320D	12 W
	GV-BL1200 GV-BL1300	6.72 W
	GV-BL1500	7.68 W
	GV-BL2500	8 W
	GV-BL2400 GV-BL3400	7.2 W
<b>Dimensions</b>	<b>Camera Body</b>	277.5 x 87.75 x 148.95 mm (10.9" x 3.45" x 5.86")
	<b>Cable Length</b>	1 m (3.28 ft)
	<b>Max. Cable Diameter</b>	ø7.1 mm (0.28")
	<b>Max. Connector Diameter</b>	ø25.2 mm (0.99")
<b>Weight</b>	GV-BL120D GV-BL130D GV-BL220D GV-BL320D GV-BL1200 GV-BL1300 GV-BL2400 GV-BL3400	1.35 kg (2.98 lb)
	GV-BL1500 GV-BL2500	1.4 Kg (3.08 lb)

## Specifications: Bullet Camera (Part 1)

Ingress Protection	GV-BL120D GV-BL130D GV-BL220D GV-BL320D	IP66
	GV-BL1200 GV-BL1300 GV-BL1500 GV-BL2400 GV-BL2500 GV-BL3400	IP67
Vandal Resistance	GV-BL1200 GV-BL1300 GV-BL1500 GV-BL2400 GV-BL2500 GV-BL3400	IK10 for metal casing
Regulatory	GV-BL120D GV-BL130D GV-BL220D GV-BL320D GV-BL1200 GV-BL1300 GV-BL1500 GV-BL2400 GV-BL3400	CE, FCC, C-Tick, RoHS compliant
	GV-BL1500 GV-BL2500	CE, FCC, RCM, RoHS compliant

## Power over Ethernet

<b>PoE Standard</b>	IEEE 802.3af Power over Ethernet / PD
<b>PoE Power Supply Type</b>	End-Span
<b>PoE Power Output</b>	Per Port 48V DC, 350mA. Max. 15.4 watts

## Web Interface

<b>Installation Management</b>	Web-based configuration
<b>Maintenance</b>	Firmware upgrade through Web Browser or Utility
<b>Access from Web Browser</b>	Camera live view, video recording, change video quality, bandwidth control, image snapshot, digital I/O control, audio, Picture in Picture, Picture and Picture, Privacy Mask, Visual Automation, Tampering Alarm, Text Overlay, Digital PTZ
<b>Language</b>	Arabic / Bulgarian / Czech / Danish / Dutch / English / Finnish / French / German / Greek / Hebrew / Hungarian / Indonesian / Italian / Japanese / Lithuanian / Norwegian / Persian / Polish / Portuguese / Romanian / Russian / Serbian / Simplified Chinese / Slovakian / Slovenian / Spanish / Swedish / Thai / Traditional Chinese / Turkish

## Specifications: Bullet Camera (Part 1)

### Application

<b>Network Storage</b>	GV-NVR, GV-System, GV-Backup Center, GV-Recording Server
<b>Smart Device Access</b>	GV-Eye for Android smartphone, tablet, iPhone, and iPod Touch; GV-Eye HD for iPad
<b>Live Viewing</b>	IE, mobile phone
<b>CMS Server support</b>	GV-Control Center, GV-Center V2, GV-VSM

All specifications are subject to change without prior notice.



# Specifications: Bullet Camera

## (Part 2)

This section details the specifications on **GV-BL1210 / 1510 / 2410 / 2510 / 3410 / 5310**.

### Camera

<b>Image Sensor</b>	<b>GV-BL1210</b>	1/3" progressive scan low lux CMOS	
	<b>GV-BL1510</b>	1/3" progressive scan super low lux CMOS	
	<b>GV-BL2510</b>	1/2.8" progressive scan super low lux CMOS	
	<b>GV-BL2410</b> <b>GV-BL3410</b>	1/3.2" progressive scan CMOS	
	<b>GV-BL5310</b>	1/2.5" progressive scan CMOS	
<b>Picture Elements</b>	<b>GV-BL1210</b> <b>GV-BL1510</b>	1280 (H) x 1024 (V)	
	<b>GV-BL2410</b> <b>GV-BL2510</b>	1920 (H) x 1080 (V)	
	<b>GV-BL3410</b>	2048 (H) x 1536 (V)	
	<b>GV-BL5310</b>	2560 (H) x 1920 (V)	
<b>Minimum Illumination</b>	<b>GV-BL1210</b>	<b>Color</b>	0.05 Lux
		<b>B/W</b>	0.03 Lux
		<b>IR ON</b>	0 Lux

## Specifications: Bullet Camera (Part 2)

<b>Minimum Illumination</b>	<b>GV-BL1510</b>	<b>Color</b>	0.01 Lux
		<b>B/W</b>	0.01 Lux
		<b>IR ON</b>	0 Lux
	<b>GV-BL2510</b>	<b>Color</b>	0.02 Lux
		<b>B/W</b>	0.02 Lux
		<b>IR ON</b>	0 Lux
	<b>GV-BL2410</b> <b>GV-BL3410</b>	<b>Color</b>	0.08 Lux
		<b>B/W</b>	0.05 Lux
	<b>GV-BL5310</b>	<b>IR ON</b>	0 Lux
<b>Color</b>		0.15 Lux	
<b>B/W</b>		0.10 Lux	
<b>IR ON</b>	0 Lux		
<b>Shutter Speed</b>		Automatic, Manual (1/5 ~ 1/8000 sec)	
<b>White Balance</b>		Automatic, Manual (2800K ~ 8500K)	
<b>Gain Control</b>		Automatic	
<b>S/N Ratio</b>	<b>GV-BL1210</b>	50 dB	
	<b>GV-BL1510</b>	55 dB	
	<b>GV-BL2510</b>	52 dB	
	<b>GV-BL2410</b> <b>GV-BL3410</b>	47 dB	
	<b>GV-BL5310</b>	45 dB	
<b>WDR Pro</b>	<b>GV-BL2410</b> <b>GV-BL3410</b>	Yes (with WDR sensor)	
<b>WDR</b>		Yes	

### Lens

<b>Megapixel</b>	Yes
------------------	-----

<b>Day / Night</b>		Yes (with removable IR-cut filter)	
<b>Lens Type</b>		Motorized varifocal lens	
<b>Focal Length</b>	GV-BL1210 GV-BL1510 GV-BL2410 GV-BL2510 GV-BL3410	3 ~ 9 mm	
	GV-BL5310	4.5 ~ 9 mm	
<b>Maximum Aperture</b>		F/1.2	
<b>Mount</b>		∅ 14 mm	
<b>Image Format</b>		1/2.7"	
<b>Horizontal FOV</b>	GV-BL1210	86° ~ 32°	
	GV-BL1510	90° ~ 32°	
	GV-BL2410	82° ~ 30°	
	GV-BL2510	103° ~ 36°	
	GV-BL3410	86° ~ 31°	
	GV-BL5310	70° ~ 39°	
<b>Operation</b>	<b>Focus</b>		Auto Focus
	<b>Zoom</b>	GV-BL1210 GV-BL1510 GV-BL2410 GV-BL2510 GV-BL3410	3x Optical Zoom
		GV-BL5310	2x Optical Zoom
		<b>Iris</b>	
<b>IR LED Quantity</b>		16 IR LEDs	

## Specifications: Bullet Camera (Part 2)

<b>Max. IR Distance</b>	<b>GV-BL1210</b> <b>GV-BL5310</b>	40 m (131 ft)
	<b>GV-BL1510</b>	70 m (230 ft)
	<b>GV-BL2410</b> <b>GV-BL2510</b> <b>GV-BL3410</b>	50 m (164 ft)

## Operation

<b>Video Compression</b>		H.264, MJPEG
<b>Video Stream</b>		Dual streams from H.264 or MJPEG
<b>Frame Rate</b>	<b>GV-BL1210</b> <b>GV-BL1510</b>	30 fps at 1280 x 1024
	<b>GV-BL2410</b> <b>GV-BL2510</b>	30 fps at 1920 x 1080
	<b>GV-BL3410</b>	20 fps at 2048 x 1536
	<b>GV-BL5310</b>	10 fps at 2560 x 1920
	<b>Image Setting</b>	
<b>Audio Compression</b>		G.711, AAC (Optional)
<b>Audio Support</b>		Two-Way Audio
<b>Sensor Input</b>		1 Input (Dry Contact)
<b>Alarm Output</b>		1 Output (200mA 5V DC)

**Note:**

1. The frame rate and performance may vary depending on the number of connections and data bitrates (different scenes).
2. The Super Low Lux adjustment (Image Settings) is only available for GV-BL1510/2510.

## Video Resolution

GV-BL1210 GV-BL1510	Main Stream	4:3	1280 x 960, 640 x 480, 320 x 240
		16:9	1280 x 720, 640 x 360, 448 x 252
		5:4	1280 x 1024, 640 x 512, 320 x 256
	Sub Stream	4:3	640 x 480, 320 x 240
		16:9	640 x 360, 448 x 252
		5:4	640 x 512, 320 x 256
GV-BL2410 GV-BL2510	Main Stream	4:3	1600 x 1200, 1280 x 960, 640 x 480, 320 x 240
		16:9	1920 x 1080, 1280 x 720, 640 x 360, 448 x 252
		5:4	1280 x 1024, 640 x 480, 320 x 240
	Sub Stream	4:3	640 x 480, 320 x 240
		16:9	640 x 360, 448 x 252
		5:4	640 x 480, 320 x 240

## Specifications: Bullet Camera (Part 2)

GV-BL3410	Main Stream	4:3	2048 x 1536, 1600 x 1200, 1280 x 960, 640 x 480, 320 x 240
		16:9	1920 x 1080, 1280 x 720, 640 x 360, 448 x 252
		5:4	1280 x 1024, 640 x 512, 320 x 256
	Sub Stream	4:3	640 x 480, 320 x 240
		16:9	640 x 360, 448 x 252
		5:4	640 x 512, 320 x 256
GV-BL5310	Main Stream	4:3	2560 x 1920, 2048 x 1536, 1600 x 1200, 1280 x 960, 640 x 480, 320 x 240
		16:9	1920 x 1080, 1280 x 720, 640 x 360, 448 x 252
		5:4	1280 x 1024, 640 x 512, 320 x 256
	Sub Stream	4:3	640 x 480, 320 x 240
		16:9	640 x 360, 448 x 252
		5:4	640 x 512, 320 x 256

## Network

Interface	10/100 Ethernet
Protocol	DHCP, DynDNS, FTP, HTTP, HTTPS, NTP, ONVIF (Profile S), PSIA, QoS (DSCP), RTSP, SNMP, SMTP, TCP, UDP, UPnP, 3GPP/ISMA

## Mechanical

<b>Camera Angle Adjustment</b>	<b>Pan</b>	0° ~ 360°
	<b>Tilt</b>	90° ~ 180°
	<b>Rotate</b>	0° ~ 360°
<b>Temperature Detector</b>		Yes
<b>Connectors</b>	<b>Power</b>	2-pin terminal block, PoE
	<b>Ethernet</b>	Ethernet (10/100 Base-T), RJ-45 cable
	<b>Audio</b>	1 In (Brown terminal block or RCA female for microphone); 1 Out (Green terminal block RCA female for speaker)
	<b>Digital I/O</b>	I/O Wire
	<b>Local Storage</b>	Micro SD card slot (SD/SDHC, version 2.0 only, Class 10)
<b>Note:</b> SDXC and UHS-I card types are not supported.		

## General

<b>Environment Temperature</b>		-20°C ~ 50°C (-4°F ~ 122°F)
<b>Humidity</b>		10% to 90% (no condensation)
<b>Power Source</b>		12V DC / 24V AC / PoE
<b>Max. Power Consumption</b>	<b>GV-BL1210</b>	11.52 W
	<b>GV-BL2410</b>	
	<b>GV-BL1510</b>	13.8 W
	<b>GV-BL2510</b>	13.4 W
	<b>GV-BL3410</b> <b>GV-BL5310</b>	12.48 W

## Specifications: Bullet Camera (Part 2)

<b>Dimensions</b>	<b>Camera Body</b>	289.02 x 87.75 x 148.95 mm (11.4" x 3.45" x 5.86")
	<b>Cable Length</b>	1 m (3.28 ft)
	<b>Max. Cable Diameter</b>	ø7.1 mm (0.28")
	<b>Max. Connector Diameter</b>	ø25.2 mm (0.99")
<b>Weight</b>		1.4 Kg (3.08 lb)
<b>Ingress Protection</b>		IP67
<b>Vandal Resistance</b>		IK10 for metal casing
<b>Regulatory</b>	<b>GV-BL1210 GV-BL2410 GV-BL3410 GV-BL5310</b>	CE, FCC, C-Tick, RoHS compliant
	<b>GV-BL1510 GV-BL2510</b>	CE, FCC, RCM, RoHS compliant

### Power over Ethernet

<b>PoE Standard</b>	IEEE 802.3af Power over Ethernet / PD
<b>PoE Power Supply Type</b>	End-Span
<b>PoE Power Output</b>	Per Port 48V DC, 350mA. Max. 15.4 watts

### Web Interface

<b>Installation Management</b>	Web-based configuration
<b>Maintenance</b>	Firmware upgrade through Web Browser or Utility



<b>Access from Web Browser</b>	Camera live view, video recording, change video quality, bandwidth control, image snapshot, digital I/O control, audio, Picture in Picture, Picture and Picture, Privacy Mask, Visual Automation, Tampering Alarm, Text Overlay, Digital PTZ
<b>Language</b>	Arabic / Bulgarian / Czech / Danish / Dutch / English / Finnish / French / German / Greek / Hebrew / Hungarian / Indonesian / Italian / Japanese / Lithuanian / Norwegian / Persian / Polish / Portuguese / Romanian / Russian / Serbian / Simplified Chinese / Slovakian / Slovenian / Spanish / Swedish / Thai / Traditional Chinese / Turkish

## Application

<b>Network Storage</b>	GV-NVR, GV-System, GV-Backup Center, GV-Recording Server
<b>Smart Device Access</b>	GV-Eye for Android smartphone, tablet, iPhone, and iPod Touch; GV-Eye HD for iPad
<b>Live Viewing</b>	IE, mobile phone
<b>CMS Server support</b>	GV-Control Center, GV-Center V2, GV-VSM

All specifications are subject to change without prior notice.

# Specifications: Ultra Bullet

## Camera

### Camera

Image Sensor	<b>GV-UBL1211</b>	1/3" progressive scan low lux CMOS	
	<b>GV-UBL1301 Series</b>	1/2.5" progressive scan CMOS	
	<b>GV-UBL1511</b>	1/3" progressive scan super low lux CMOS	
	<b>GV-UBL2511</b>	1/2.8" progressive scan super low lux CMOS	
	<b>GV-UBL2411</b> <b>GV-UBL3411</b> <b>GV-UBL2401 Series</b> <b>GV-UBL3401 Series</b>	1/3.2" progressive scan CMOS	
Picture Elements	<b>GV-UBL1211</b> <b>GV-UBL1301 Series</b> <b>GV-UBL1511</b>	1280 (H) x 1024 (V)	
	<b>GV-UBL2411</b> <b>GV-UBL2401 Series</b> <b>GV-UBL2511</b>	1920 (H) x 1080 (V)	
	<b>GV-UBL3411</b> <b>GV-UBL3401 Series</b>	2048 (H) x 1536 (V)	
Minimum Illumination	<b>GV-UBL1211</b>	<b>Color</b>	0.05 Lux
		<b>B/W</b>	0.03 Lux
		<b>IR ON</b>	0 Lux

<b>Minimum Illumination</b>	<b>GV-UBL1511</b>	<b>Color</b>	0.01 Lux
		<b>B/W</b>	0.01 Lux
		<b>IR ON</b>	0 Lux
	<b>GV-UBL2511</b>	<b>Color</b>	0.02 Lux
		<b>B/W</b>	0.02 Lux
		<b>IR ON</b>	0 Lux
	<b>GV-UBL2411</b> <b>GV-UBL3411</b>	<b>Color</b>	0.08 Lux
		<b>B/W</b>	0.05 Lux
		<b>IR ON</b>	0 Lux
	<b>GV-UBL1301 Series</b>	<b>Color</b>	0.15 Lux
		<b>B/W</b>	0.10 Lux
		<b>IR ON</b>	0 Lux
<b>GV-UBL2401 Series</b> <b>GV-UBL3401 Series</b>	<b>Color</b>	0.08 Lux	
	<b>B/W</b>	0.05 Lux	
	<b>IR ON</b>	0 Lux	
<b>Shutter Speed</b>		Automatic, Manual (1/5 ~ 1/8000 sec)	
<b>White Balance</b>		Automatic, Manual (2800K ~ 8500K)	
<b>Gain Control</b>		Automatic	
<b>S/N Ratio</b>	<b>GV-UBL1211</b>	50 dB	
	<b>GV-UBL1301 Series</b>	45 dB	
	<b>GV-UBL1511</b>	55 dB	
	<b>GV-UBL2511</b>	52 dB	
	<b>GV-UBL2411</b> <b>GV-UBL3411</b> <b>GV-UBL2401 Series</b> <b>GV-UBL3401 Series</b>	47 dB	
<b>WDR Pro</b>	<b>GV-UBL2411</b> <b>GV-UBL3411</b> <b>GV-UBL2401 Series</b> <b>GV-UBL3401 Series</b>	Yes (with WDR sensor)	

## Specifications: Ultra Bullet Camera

<b>WDR</b>	Yes
------------	-----

### Lens

<b>Megapixel</b>	Yes	
<b>Day / Night</b>	Yes (with removable IR-cut filter)	
<b>Lens Type</b>	GV-UBL1211 GV-UBL1511 GV-UBL2411 GV-UBL2511 GV-UBL3411	Motorized varifocal Lens
	GV-UBL1301 Series GV-UBL2401 Series GV-UBL3401 Series	Fixed Lens
<b>Focal Length</b>	GV-UBL1211 GV-UBL1511 GV-UBL2411 GV-UBL2511 GV-UBL3411	3 ~ 9 mm
	GV-UBL1301-0F GV-UBL2401-0F GV-UBL3401-0F	3 mm
	GV-UBL1301-1F GV-UBL2401-1F GV-UBL3401-1F	4 mm
	GV-UBL1301-2F GV-UBL2401-2F GV-UBL3401-2F	8 mm
	GV-UBL1301-3F GV-UBL2401-3F GV-UBL3401-3F	12 mm

<b>Maximum Aperture</b>	GV-UBL1211 GV-UBL1511 GV-UBL2411 GV-UBL2511 GV-UBL3411	F/1.2
	GV-UBL1301-0F GV-UBL2401-0F GV-UBL3401-0F	F/2.0
	GV-UBL1301-1F GV-UBL2401-1F GV-UBL3401-1F	F/1.5
	GV-UBL1301-2F GV-UBL2401-2F GV-UBL3401-2F GV-UBL1301-3F GV-UBL2401-3F GV-UBL3401-3F	F/1.6
<b>Mount</b>	GV-UBL1211 GV-UBL1511 GV-UBL2411 GV-UBL2511 GV-UBL3411	ø 14 mm
	GV-UBL1301 Series GV-UBL2401 Series GV-UBL3401 Series	M12

## Specifications: Ultra Bullet Camera

Image Format	GV-UBL1211 GV-UBL1511 GV-UBL2411 GV-UBL2511 GV-UBL3411	1/2.7"	
	GV-UBL1301 Series GV-UBL2401 Series GV-UBL3401 Series	1/3"	
Horizontal FOV	GV-UBL1211	86° ~ 32°	
	GV-UBL1511	90° ~ 32°	
	GV-UBL2411	82° ~ 30°	
	GV-UBL2511	103° ~ 36°	
	GV-UBL3411	86° ~ 31°	
	GV-UBL1301-0F	66°	
	GV-UBL2401-0F	80°	
	GV-UBL3401-0F	87°	
	GV-UBL1301-1F	49°	
	GV-UBL2401-1F	58°	
	GV-UBL3401-1F	62°	
	GV-UBL1301-2F	25°	
	GV-UBL2401-2F	31°	
	GV-UBL3401-2F	33°	
	GV-UBL1301-3F	16°	
GV-UBL2401-3F	20°		
GV-UBL3401-3F	21°		
Operation	GV-UBL1211 GV-UBL1511 GV-UBL2411 GV-UBL2511 GV-UBL3411	Focus	Auto Focus
		Zoom	3x Optical Zoom
		Iris	DC Drive

Operation	GV-UBL1301 Series	Focus	Fixed
	GV-UBL2401 Series	Zoom	
	GV-UBL3401 Series	Iris	
IR LED Quantity		4 IR LEDs	
Max. IR Distance		10 m (32.81 ft)	

## Operation

Video Compression		H.264, MJPEG
Video Stream		Dual streams from H.264 or MJPEG
Frame Rate	GV-UBL1211 GV-UBL1301 Series GV-UBL1511	30 fps at 1280 x 1024
	GV-UBL2411 GV-UBL2401 Series GV-UBL2511	30 fps at 1920 x 1080
	GV-UBL3411 GV-UBL3401 Series	20 fps at 2048 x 1536
Image Setting		Brightness, Contrast, Sharpness, Gamma, White Balance, Flicker-less, Image Orientation, Shutter Speed, D/N Sensitivity, Backlight Compensation, WDR, Defog, Zoom, Focus Change, Super Low Lux
Audio Support		No
<b>Note:</b> <ol style="list-style-type: none"> <li>The frame rate and performance may vary depending on the number of connections and data bitrates (different scenes).</li> <li>The super low lux adjustment (Image Settings) is only available for GV-UBL1511 / 2511.</li> </ol>		

## Specifications: Ultra Bullet Camera

### Video Resolution

<b>GV-UBL1211</b> <b>GV-UBL1301 Series</b> <b>GV-UBL1511</b>	<b>Main Stream</b>	<b>4:3</b>	1280 x 960, 640 x 480, 320 x 240
		<b>16:9</b>	1280 x 720, 640 x 360, 448 x 252
		<b>5:4</b>	1280 x 1024, 640 x 512, 320 x 256
	<b>Sub Stream</b>	<b>4:3</b>	640 x 480, 320 x 240
		<b>16:9</b>	640 x 360, 448 x 252
		<b>5:4</b>	640 x 512, 320 x 256
<b>GV-UBL2411</b> <b>GV-UBL2401 Series</b> <b>GV-UBL2511</b>	<b>Main Stream</b>	<b>4:3</b>	1600 x 1200, 1280 x 960, 640 x 480, 320 x 240
		<b>16:9</b>	1920 x 1080, 1280 x 720, 640 x 360, 448 x 252
		<b>5:4</b>	1280 x 1024, 640 x 512, 320 x 256
	<b>Sub Stream</b>	<b>4:3</b>	640 x 480, 320 x 240
		<b>16:9</b>	640 x 360, 448 x 252
		<b>5:4</b>	640 x 512, 320 x 256
<b>GV-UBL3411</b> <b>GV-UBL3401 Series</b>	<b>Main Stream</b>	<b>4:3</b>	2048 x 1536, 1600 x 1200, 1280 x 960, 640 x 480, 320 x 240
		<b>16:9</b>	1920 x 1080, 1280 x 720, 640 x 360, 448 x 252
		<b>5:4</b>	1280 x 1024, 640 x 512, 320 x 256
	<b>Sub Stream</b>	<b>4:3</b>	640 x 480, 320 x 240
		<b>16:9</b>	640 x 360, 448 x 252
		<b>5:4</b>	640 x 512, 320 x 256



## Network

<b>Interface</b>	10/100 Ethernet
<b>Protocol</b>	DHCP, DynDNS, FTP, HTTP, HTTPS, NTP, ONVIF (Profile S), PSIA, QoS (DSCP), RTSP, SNMP, SMTP, TCP, UDP, UPnP, 3GPP/ISMA

## Mechanical

<b>Temperature Detector</b>	Yes	
<b>Connectors</b>	<b>Power</b>	2-pin terminal block, PoE
	<b>Ethernet</b>	Ethernet (10/100 Base-T), RJ-45 cable Two types of models for selection: Waterproof or Non-Waterproof with smaller size
	<b>Digital I/O</b>	I/O Wire
	<b>Local Storage</b>	Micro SD card slot (SD/SDHC, version 2.0 only, Class 10)
<b>Note:</b> SDXC and UHS-I card types are not supported.		

## General

<b>Environment Temperature</b>	GV-UBL1211 GV-UBL1511 GV-UBL2411 GV-UBL2511 GV-UBL3411	-10°C ~ 45°C (14°F ~ 113°F)
	GV-UBL2401 Series GV-UBL3401 Series	-20°C ~ 45°C (-4°F ~ 113°F)

## Specifications: Ultra Bullet Camera

<b>Environment Temperature</b>	<b>GV-UBL1301 Series</b>	<b>Start-up</b>	-20°C ~ 45°C (-4°F ~ 113°F)
		<b>Operation</b>	-30°C ~ 45°C (-22°F ~ 113°F)
<b>Humidity</b>		10% to 90% (no condensation)	
<b>Power Source</b>		5V DC / PoE	
<b>Max. Power Consumption</b>	<b>GV-UBL1211</b> <b>GV-UBL2411</b> <b>GV-UBL3411</b>	6.94 W	
	<b>GV-UBL1511</b>	9.65 W	
	<b>GV-UBL2511</b>	9.95 W	
	<b>GV-UBL1301 Series</b> <b>GV-UBL2401 Series</b> <b>GV-UBL3401 Series</b>	5.52 W	
<b>Dimensions</b>	<b>GV-UBL1211</b> <b>GV-UBL1511</b> <b>GV-UBL2411</b> <b>GV-UBL2511</b> <b>GV-UBL3411</b>	148.75 x 65 x 69 mm (5.9" x 2.6" x 2.7")	
	<b>GV-UBL1301 Series</b> <b>GV-UBL2401 Series</b> <b>GV-UBL3401 Series</b>	124 x 65 x 69 mm (4.8" x 2.6" x 2.7")	
<b>Weight</b>	<b>GV-UBL1211</b> <b>GV-UBL1511</b> <b>GV-UBL2411</b> <b>GV-UBL2511</b> <b>GV-UBL3411</b>	850 g (1.9 lb)	

<b>Weight</b>	<b>GV-UBL1301 Series</b> <b>GV-UBL2401 Series</b> <b>GV-UBL3401 Series</b>	730 g (1.6 lb)
<b>Ingress Protection</b>		IP67
<b>Vandal Resistance</b>		IK10 for metal casing
<b>Regulatory</b>	<b>GV-UBL1211</b> <b>GV-UBL2411</b> <b>GV-UBL3411</b> <b>GV-UBL1301 Series</b> <b>GV-UBL2401 Series</b> <b>GV-UBL3401 Series</b>	CE, FCC, C-Tick, RoHS compliant
	<b>GV-UBL1511</b> <b>GV-UBL2511</b>	CE, FCC, RCM, RoHS compliant

## Power over Ethernet

<b>PoE Standard</b>	IEEE 802.3af Power over Ethernet / PD
<b>PoE Power Supply Type</b>	End-Span
<b>PoE Power Output</b>	Per Port 48V DC, 350mA. Max. 15.4 watts

## Web Interface

<b>Installation Management</b>	Web-based configuration
<b>Maintenance</b>	Firmware upgrade through Web Browser or Utility

## Specifications: Ultra Bullet Camera

<b>Access from Web Browser</b>	Camera live view, video recording, change video quality, bandwidth control, image snapshot, digital I/O control, Picture in Picture, Picture and Picture, Privacy Mask, Visual Automation, Tampering Alarm, Text Overlay, Digital PTZ
<b>Language</b>	Arabic / Bulgarian / Czech / Danish / Dutch / English / Finnish / French / German / Greek / Hebrew / Hungarian / Indonesian / Italian / Japanese / Lithuanian / Norwegian / Persian / Polish / Portuguese / Romanian / Russian / Serbian / Simplified Chinese / Slovakian / Slovenian / Spanish / Swedish / Thai / Traditional Chinese / Turkish

## Application

<b>Network Storage</b>	GV-NVR, GV-System, GV-Backup Center, GV-Recording Server
<b>Smart Device Access</b>	GV-Eye for Android smartphone, tablet, iPhone, and iPod Touch; GV-Eye HD for iPad
<b>Live Viewing</b>	IE, mobile phone
<b>CMS Server support</b>	GV-Control Center, GV-Center V2, GV-VSM

All specifications are subject to change without prior notice

# Specifications: Target Bullet

## Camera

### Camera

<b>Image Sensor</b>		1/3" progressive scan low lux CMOS
<b>Picture Elements</b>		1280 (H) x 1024 (V)
<b>Minimum Illumination</b>	<b>Color</b>	0.05 Lux
	<b>B/W</b>	0.03 Lux
	<b>IR ON</b>	0 Lux
<b>Shutter Speed</b>		Automatic, Manual (1/5 ~ 1/8000 sec)
<b>White Balance</b>		Automatic, Manual (2800K ~ 8500K)
<b>Gain Control</b>		Automatic
<b>S/N Ratio</b>		50 dB
<b>WDR</b>		Yes

### Lens

<b>Megapixel</b>		Yes
<b>Day / Night</b>		Yes (with removable IR-cut filter)
<b>Lens Type</b>		Fixed Lens
<b>Focal Length</b>	<b>GV-EBL1100-0F</b>	3.8 mm
	<b>GV-EBL1100-1F</b>	6 mm
<b>Maximum Aperture</b>		F/1.8
<b>Mount</b>		M12, Pitch 0.5 mm
<b>Image Format</b>		1/2.7"
<b>Horizontal FOV</b>	<b>GV-EBL1100-0F</b>	64°
	<b>GV-EBL1100-1F</b>	44°

## Specifications: Target Bullet Camera

<b>Operation (Focus / Zoom / Iris)</b>	Fixed
<b>IR LED Quantity</b>	24 IR LEDs
<b>Max. IR Distance</b>	30 m (98.4 ft)

### Operation

<b>Video Compression</b>	H.264, MJPEG
<b>Video Stream</b>	Dual streams from H.264 or MJPEG
<b>Frame Rate</b>	30 fps at 1280 x 1024
<b>Image Setting</b>	Brightness, Contrast, Sharpness, Gamma, White Balance, Flicker-less, Image Orientation, Shutter Speed, D/N Sensitivity, Backlight Compensation, WDR, Defog
<b>Audio Support</b>	No
<b>Note:</b> The frame rate and performance may vary depending on the number of connections and data bitrates (different scenes).	

### Video Resolution

<b>Main Stream</b>	<b>4:3</b>	1280 x 960, 640 x 480, 320 x 240
	<b>16:9</b>	1280 x 720, 640 x 360, 448 x 252
	<b>5:4</b>	1280 x 1024, 640 x 512, 320 x 256
<b>Sub Stream</b>	<b>4:3</b>	640 x 480, 320 x 240
	<b>16:9</b>	640 x 360, 448 x 252
	<b>5:4</b>	640 x 512, 320 x 256

### Network

<b>Interface</b>	10/100 Ethernet
------------------	-----------------

<b>Protocol</b>	DHCP, DynDNS, FTP, HTTP, HTTPS, NTP, ONVIF (Profile S), QoS (DSCP), RTSP, SNMP, SMTP, TCP, UDP, UPnP, 3GPP/ISMA
-----------------	---

## Mechanical

<b>Connectors</b>	<b>Power</b>	2-pin terminal block, PoE
	<b>Ethernet</b>	Ethernet (10/100 Base-T), RJ-45 cable

## General

<b>Environment Temperature</b>	<b>Start-up</b>	-20°C ~ 50°C (-4°F ~ 122°F)
	<b>Operation</b>	-30°C ~ 50°C (-22°F ~ 122°F)
<b>Humidity</b>	10% to 90% (no condensation)	
<b>Power Source</b>	12V DC / PoE	
<b>Max. Power Consumption</b>	7.8 W	
<b>Dimensions</b>	115 x 76 x 73 mm (4.5" x 3.0" x 2.9")	
<b>Weight</b>	547 g (1.20 lb)	
<b>Ingress Protection</b>	IP67	
<b>Vandal Resistance</b>	IK10 for metal casing	
<b>Regulatory</b>	CE, FCC, C-Tick, RCM, RoHS compliant	

## Power over Ethernet

<b>PoE Standard</b>	IEEE 802.3af Power over Ethernet / PD
<b>PoE Power Supply Type</b>	End-Span
<b>PoE Power Output</b>	Per Port 48V DC, 350mA. Max. 15.4 watts

## Specifications: Target Bullet Camera

### Web Interface

<b>Installation Management</b>	Web-based configuration
<b>Maintenance</b>	Firmware upgrade through Web Browser or Utility
<b>Access from Web Browser</b>	Camera live view, video recording, change video quality, bandwidth control, image snapshot, Picture in Picture, Picture and Picture, Privacy Mask, Tampering Alarm, Text Overlay, Digital PTZ
<b>Language</b>	Arabic / Bulgarian / Czech / Danish / Dutch / English / Finnish / French / German / Greek / Hebrew / Hungarian / Indonesian / Italian / Japanese / Lithuanian / Norwegian / Persian / Polish / Portuguese / Romanian / Russian / Serbian / Simplified Chinese / Slovakian / Slovenian / Spanish / Swedish / Thai / Traditional Chinese / Turkish

### Application

<b>Network Storage</b>	GV-NVR, GV-System, GV-Recording Server
<b>Smart Device Access</b>	GV-Eye for Android smartphone, tablet, iPhone, and iPod Touch; GV-Eye HD for iPad
<b>Live Viewing</b>	IE, mobile phone
<b>CMS Server support</b>	GV-Control Center, GV-Center V2, GV-VSM

All specifications are subject to change without prior notice.



# Specifications: PTZ Camera

## Camera

<b>Model Name</b>	<b>GV-PTZ010D-N</b>	<b>GV-PTZ010D-P</b>
<b>Image Sensor</b>	1/4" CCD image sensor	
<b>Picture Elements</b>	704 (H) x 480 (V)	704 (H) x 576 (V)
<b>Minimum Illumination</b>	<b>Color</b>	2.5 Lux at F/1.8
	<b>B/W</b>	0.07 Lux at F/1.8
<b>Shutter Speed</b>	Automatic, Manual (1/60 ~ 1/120,000 sec)	Automatic, Manual (1/50 ~ 1/120,000 sec)
<b>White Balance</b>	Manual (3200K ~ 9600K)	
<b>Gain Control</b>	Automatic	

## Lens

<b>Day/Night</b>	Yes (electronic)	
<b>Focal Length</b>	4.2 ~ 42 mm	
<b>Maximum Aperture</b>	F/1.8 ~ F/2.9	
<b>Image Format</b>	1/4"	
<b>Operation</b>	<b>Focus</b>	Auto Focus
	<b>Zoom</b>	100x (10x Optical, 10x Digital)
	<b>Iris</b>	Fixed

## Operation

<b>Model Name</b>		<b>GV-PTZ010D-N</b>	<b>GV-PTZ010D-P</b>
<b>Video Format</b>		NTSC	PAL
<b>Video Compression</b>		H.264, MPEG4, MJPEG	
<b>Video Stream</b>		Dual Streams from two of H.264, MPEG4 or MJPEG	
<b>Video Resolution</b>	<b>Main Stream</b>	704 x 480 704 x 240 352 x 240	704 x 576 704 x 288 352 x 288
	<b>Sub Stream</b>	704 x 480 704 x 240 352 x 240	704 x 576 704 x 288 352 x 288
<b>Frame Rate</b>		30 fps	25 fps
<b>Image Setting</b>		Exposure Control, White Balance, Image Orientation, Backlight Compensation, Gamma	
<b>Audio Compression</b>		G.711, AAC (Optional)	
<b>Audio Support</b>		Two-Way Audio	
<b>Sensor Input</b>		1 Input (Dry Contact)	
<b>Alarm Output</b>		1 Output (200mA 5V DC)	
<b>Note:</b> The frame rate and performance may vary depending on the number of connections and data bitrates (different scenes).			

## Network

<b>Interface</b>	10/100 Ethernet
<b>Protocol</b>	DHCP, DynDNS, FTP, HTTP, HTTPS, NTP, PSIA, QoS (DSCP), RTSP, SNMP, SMTP, TCP, UDP, UPnP, 3GPP/ISMA
<b>Note:</b> HTTPS, SNMP and QoS are only supported in V1.08 or later.	

## Mechanical

<b>Camera Angle Adjustment</b>	<b>Pan</b>	-175° ~ 175°
	<b>Tilt</b>	-45° ~ 90°
<b>Temperature Detector</b>		Yes
<b>Connectors</b>	<b>Power</b>	2-pin terminal block, PoE
	<b>Ethernet</b>	Ethernet (10/100 Base-T), RJ-45 cable
	<b>Audio</b>	1 In (Using a built-in or an externally connected microphone)
		1 Out (Stereo phone jack, 3.5 mm / 0.14")
	<b>Digital I/O</b>	3-pin terminal block (pitch 2.5 mm / 0.1")
<b>Local Storage</b>	Micro SD card slot (SD/SDHC, version 2.0 only, Class 10)	
<b>LED Indicator</b>		2 LEDs: Power and Status
<b>Note:</b> SDXC and UHS-I card types are not supported.		

## General

<b>Environment Temperature</b>		-10°C ~ 50°C (14°F ~ 122°F)
<b>Humidity</b>		10% to 90% (no condensation)
<b>Power Source</b>		12V DC / 24V AC / PoE
<b>Max. Power Consumption</b>		12 W
<b>Dimensions (L x W x H)</b>	<b>With mounting base and cover</b>	167.75 x 166.78 x 135.2 mm (6.6" x 6.57" x 5.32")
	<b>Without mounting base and cover</b>	124.55 x 122.73 x 133.3 mm (4.9" x 4.83" x 5.25")
<b>Weight</b>		490 g (1.08 lb)
<b>Regulatory</b>		CE, FCC, C-Tick, RoHS compliant

### Power over Ethernet

<b>PoE Standard</b>	IEEE 802.3af Power over Ethernet / PD
<b>PoE Power Supply Type</b>	End-Span
<b>PoE Power Output</b>	Per Port 48V DC, 350mA. Max. 15.4 watts

### Web Interface

<b>Installation Management</b>	Web-based configuration
<b>Maintenance</b>	Firmware upgrade through Web Browser or Utility
<b>Access from Web Browser</b>	Camera live view, video recording, change video quality, bandwidth control, image snapshot, audio, Wide Angle Lens Dewarping, Picture in Picture, Picture and Picture, Privacy Mask, Text Overlay
<b>Language</b>	Bulgarian / Czech / Danish / Dutch / English / French / German / Greek / Hebrew / Hungarian / Indonesian / Italian / Japanese / Lithuanian / Norwegian / Persian / Polish / Portuguese / Romanian / Russian / Serbian / Simplified Chinese / Slovakian / Slovenian / Spanish / Thai / Traditional Chinese / Turkish

## Application

<b>Network Storage</b>	GV-NVR, GV-System, GV-Backup Center, GV-Recording Server
<b>Smart Device Access</b>	GV-Eye for Android smartphone, tablet, iPhone, and iPod Touch; GV-Eye HD for iPad
<b>Live Viewing</b>	IE, mobile phone
<b>CMS Server support</b>	GV-Center V2, GV-VSM, GV-Control Center
<b>Note:</b> GV-Backup Center and GV-Recording Server are only supported in V1.08 or later.	

All specifications are subject to change without notice.

# Specifications: PT Camera

## Camera

<b>Image Sensor</b>		1/2.5" progressive scan CMOS
<b>Picture Elements</b>	<b>GV-PT130D</b>	1280 (H) x 1024 (V)
	<b>GV-PT220D</b>	1920 (H) x 1080 (V)
	<b>GV-PT320D</b>	2048 (H) x 1536 (V)
<b>Minimum Illumination</b>	<b>Color</b>	0.15 Lux
	<b>B/W</b>	0.10 Lux
	<b>IR ON</b>	0 Lux
<b>Shutter Speed</b>		Automatic, Manual (1/5 ~ 1/8000 sec)
<b>White Balance</b>		Automatic, Manual (2800K ~ 8500K)
<b>Gain Control</b>		Automatic
<b>S/N Ratio</b>		45 dB
<b>WDR</b>		Yes

## Lens

<b>Megapixel</b>	Yes
<b>Day/Night</b>	Yes (with removable IR-cut filter)
<b>Iris</b>	Fixed
<b>Focal Length</b>	4.0 mm
<b>Maximum Aperture</b>	F/1.5
<b>Lens Mount</b>	M12, Pitch 0.5 mm

<b>Image Format</b>		1/2.5"
<b>Horizontal FOV</b>	<b>GV-PT130D</b>	49°
	<b>GV-PT220D</b>	58°
	<b>GV-PT320D</b>	62°
<b>Operation</b>	<b>Focus</b>	Manual (w/lock)
	<b>Zoom</b>	Fixed
	<b>Iris</b>	Fixed
<b>IR LED Quantity</b>		10 IR LEDs
<b>Max. IR Distance</b>		15 m (50 ft)

## Operation

<b>Video Compression</b>		H.264, MJPEG		
<b>Video Stream</b>		Dual streams		
<b>Video Resolution</b>	<b>GV-PT130D</b>	<b>Main Stream</b>	<b>4:3</b>	1280 x 960, 640 x 480, 320 x 240
			<b>16:9</b>	1280 x 720, 640 x 360, 448 x 252
			<b>5:4</b>	1280 x 1024, 640 x 512, 320 x 256
		<b>Sub Stream</b>	<b>4:3</b>	640 x 480, 320 x 240
			<b>16:9</b>	640 x 360, 448 x 252
			<b>5:4</b>	640 x 512, 320 x 256

## Specifications: PT Camera

Video Resolution	GV-PT220D	Main Stream	4:3	1600 x 1200, 1280 x 960, 640 x 480, 320 x 240
			16:9	1920 x 1080, 1280 x 720, 640 x 360, 448 x 252
			5:4	1280 x 1024, 640 x 512, 320 x 256
		Sub Stream	4:3	640 x 480, 320 x 240
			16:9	640 x 360, 448 x 252
			5:4	640 x 512, 320 x 256
	GV-PT320D	Main Stream	4:3	2048 x 1536, 1600 x 1200, 1280 x 960, 640 x 480, 320 x 240
			16:9	1920 x 1080, 1280 x 720, 640 x 360, 448 x 252
			5:4	1280 x 1024, 640 x 512, 320 x 256
		Sub Stream	4:3	640 x 480, 320 x 240
			16:9	640 x 360, 448 x 252
			5:4	640 x 512, 320 x 256
Frame Rate	GV-PT130D	30 fps at 1280 x 1024		
	GV-PT220D	30 fps at 1920 x 1080		
	GV-PT320D	20 fps at 2048 x 1536		
Image Settings		Brightness, Contrast, Sharpness, Gamma, White Balance, Flicker-less, Image Orientation, Shutter Speed, D/N Sensitivity, Backlight Compensation, WDR, Defog		
Audio Compression		G.711, ACC (Optional)		
Audio Support		Two-Way Audio		



<b>Sensor Input</b>	1 Input (Dry Contact)
<b>Alarm Output</b>	1 Output (200mA 5V DC)
<b>Note:</b> The frame rate and performance may vary depending on the number of connections and data bitrates (different scenes).	

## Network

<b>Interface</b>	10/100 Ethernet
<b>Protocol</b>	DHCP, DynDNS, FTP, HTTP, HTTPS, NTP, ONVIF (Profile S), PSIA, QoS (DSCP), RTSP, SNMP, SMTP, TCP, UDP, UPnP, 3GPP/ISMA

## Mechanical

<b>Camera Angle Adjustment</b>	<b>Pan</b>	-175° ~ 175°
	<b>Tilt</b>	-45° ~ 90°
<b>Temperature Detector</b>		Yes
<b>Connectors</b>	<b>Power</b>	2-pin terminal block, PoE
	<b>Ethernet</b>	Ethernet (10/100 Base-T), RJ-45 cable
	<b>Audio</b>	1 In (Using a built-in or an externally connected microphone)
		1 Out (Stereo phone jack, 3.5 mm / 0.14")
	<b>Local Storage</b>	Micro SD card slot (SD/SDHC, version 2.0 only, Class 10)
<b>Digital I/O</b>	3-pin terminal block (pitch 2.5 mm / 0.1")	
<b>LED Indicator</b>		2 LEDs: Power and Status
<b>Note:</b> SDXC and UHS-I card types are not supported.		

## Specifications: PT Camera

### General

<b>Environment Temperature</b>	0°C ~ 50°C (32°F ~ 122°F)	
<b>Humidity</b>	10% to 90% (no condensation)	
<b>Power Source</b>	12V DC / 24V AC / PoE	
<b>Max. Power Consumption</b>	12.5 W (max. 1.25A at 12V DC)	
<b>Dimensions (L x W x H)</b>	<b>With mounting base and cover</b>	167.75 x 166.78 x 135.2 mm (6.6" x 6.57" x 5.32")
	<b>Without mounting base and cover</b>	124.55 x 122.73 x 133.3 mm (4.9" x 4.83" x 5.25")
<b>Weight</b>	440 g (0.97 lb)	
<b>Regulatory</b>	CE, FCC, C-Tick, RoHS compliant	

### Power over Ethernet

<b>PoE Standard</b>	IEEE 802.3af Power over Ethernet / PD
<b>PoE Power Supply Type</b>	End-Span
<b>PoE Power Output</b>	Per Port 48V DC, 350mA. Max. 15.4 watts

## Web Interface

<b>Installation Management</b>	Web-based configuration
<b>Maintenance</b>	Firmware upgrade through Web Browser or Utility
<b>Access from Web Browser</b>	Camera live view, video recording, change video quality, bandwidth control, image snapshot, audio, Picture in Picture, Picture and Picture, Text Overlay
<b>Language</b>	Bulgarian / Czech / Danish / Dutch / English / French / German / Greek / Hebrew / Hungarian / Indonesian / Italian / Japanese / Lithuanian / Norwegian / Persian / Polish / Portuguese / Romanian / Russian / Serbian / Simplified Chinese / Slovakian / Slovenian / Spanish / Thai / Traditional Chinese / Turkish

## Application

<b>Network Storage</b>	GV-NVR, GV-System, GV-Backup Center, GV-Recording Server
<b>Smart Device Access</b>	GV-Eye for Android smartphone, tablet, iPhone, and iPod Touch; GV-Eye HD for iPad
<b>Live Viewing</b>	IE, mobile phone
<b>CMS Server support</b>	GV-Center V2, GV-VSM, GV-Control Center

All specifications are subject to change without notice.

## Specifications: Vandal Proof IP

### Dome (Part 1)

This section details the specifications on **GV-VD120D / 121D / 122D / 123D**, **GV-VD220D / 221D / 222D / 223D**, **GV-VD320D / 321D / 322D / 323D** and **GV-VD1500 / 2400 / 2500 / 3400**.

#### Camera

Image Sensor	GV-VD120D GV-VD121D GV-VD122D GV-VD123D	1/3" progressive scan low lux CMOS
	GV-VD1500	1/3" progressive scan super low lux CMOS
	GV-VD2500	1/2.8" progressive scan super low lux CMOS
	GV-VD2400 GV-VD3400	1/3.2" progressive scan CMOS
	GV-VD220D GV-VD221D GV-VD222D GV-VD223D	1/2.5" progressive scan CMOS
	GV-VD320D GV-VD321D GV-VD322D GV-VD323D	

<b>Picture Elements</b>	GV-VD120D GV-VD121D GV-VD122D GV-VD123D GV-VD1500	1280 (H) x 1024 (V)		
	GV-VD220D GV-VD221D GV-VD222D GV-VD223D GV-VD2400 GV-VD2500	1920 (H) x 1080 (V)		
	GV-VD320D GV-VD321D GV-VD322D GV-VD323D GV-VD3400	2048 (H) x 1536 (V)		
	<b>Minimum Illumination</b>	GV-VD120D GV-VD121D GV-VD122D GV-VD123D	<b>Color</b>	0.05 Lux
			<b>B/W</b>	0.03 Lux
			<b>IR ON</b>	0 Lux
		GV-VD1500	<b>Color</b>	0.01 Lux
			<b>B/W</b>	0.01 Lux
			<b>IR ON</b>	0 Lux
GV-VD2500		<b>Color</b>	0.02 Lux	
		<b>B/W</b>	0.02 Lux	
		<b>IR ON</b>	0 Lux	

## Specifications: Vandal Proof IP Dome (Part 1)

<b>Minimum Illumination</b>	GV-VD220D	<b>Color</b>	0.15 Lux
	GV-VD221D	<b>B/W</b>	0.10 Lux
	GV-VD222D	<b>IR ON</b>	0 Lux
	GV-VD223D		
	GV-VD320D		
	GV-VD321D		
	GV-VD322D		
	GV-VD323D		
	GV-VD2400	<b>Color</b>	0.08 Lux
	GV-VD3400	<b>B/W</b>	0.05 Lux
	<b>IR ON</b>	0 Lux	
<b>Shutter Speed</b>		Automatic, Manual (1/5 ~ 1/8000 sec)	
<b>White Balance</b>		Automatic, Manual (2800K ~ 8500K)	
<b>Gain Control</b>		Automatic	
<b>S/N Ratio</b>	GV-VD120D	50 dB	
	GV-VD121D		
	GV-VD122D		
	GV-VD123D		
	GV-VD1500	55 dB	
	GV-VD2500	52 dB	
	GV-VD220D	45 dB	
	GV-VD221D		
	GV-VD222D		
	GV-VD223D		
GV-VD320D			
GV-VD321D			
GV-VD322D			
GV-VD323D			

<b>S/N Ratio</b>	<b>GV-VD2400</b> <b>GV-VD3400</b>	47 dB
<b>WDR Pro</b>	<b>GV-VD2400</b> <b>GV-VD3400</b>	Yes
<b>WDR</b>		Yes

## Lens

<b>Megapixel</b>		Yes
<b>Day/Night</b>		Yes (with removable IR-cut filter)
<b>Lens Type</b>		Varifocal
<b>Focal Length</b>		3 ~ 9 mm
<b>Maximum Aperture</b>	<b>GV-VD120D</b>	F/1.3
	<b>GV-VD121D</b>	
	<b>GV-VD122D</b>	
	<b>GV-VD123D</b>	
	<b>GV-VD220D</b>	
	<b>GV-VD221D</b>	
	<b>GV-VD222D</b>	
	<b>GV-VD223D</b>	
	<b>GV-VD320D</b>	
	<b>GV-VD321D</b>	
	<b>GV-VD322D</b>	
	<b>GV-VD323D</b>	
	<b>GV-VD1500</b>	F/1.2
	<b>GV-VD2400</b>	
	<b>GV-VD2500</b>	
	<b>GV-VD3400</b>	

## Specifications: Vandal Proof IP Dome (Part 1)

<b>Mount</b>		ø 14 mm
<b>Image Format</b>	GV-VD120D	1/3"
	GV-VD121D	
	GV-VD122D	
	GV-VD123D	
	GV-VD1500	
	GV-VD220D	
	GV-VD221D	
	GV-VD222D	
	GV-VD223D	
	GV-VD320D	
	GV-VD321D	
	GV-VD322D	
	GV-VD323D	
	GV-VD2400	1/2.7"
GV-VD2500		
GV-VD3400		
<b>Horizontal FOV</b>	GV-VD120D	86° ~ 32°
	GV-VD220D	82° ~ 30°
	GV-VD320D	86° ~ 31°
	GV-VD1500	90° ~ 32°
	GV-VD2400	82° ~ 30°
	GV-VD2500	103° ~ 36°
	GV-VD3400	86° ~ 31°
<b>Operation</b>	<b>Focus</b>	Manual (w/lock)
	<b>Zoom</b>	Manual (w/lock)
	<b>Iris</b>	DC drive
<b>IR LED Quantity</b>		10 IR LEDs



<b>Max. IR Distance</b>	GV-VD120D GV-VD121D GV-VD122D GV-VD123D GV-VD220D GV-VD221D GV-VD222D GV-VD223D GV-VD320D GV-VD321D GV-VD322D GV-VD323D	15 m (50 ft)
	GV-VD1500 GV-VD2400 GV-VD3400	
	GV-VD1500 GV-VD2400 GV-VD2500 GV-VD3400	30 m (98.4 ft)
	<b>Max. Torque (Focus / Zoom Screws)</b>	0.049 N.m

## Operation

<b>Video Compression</b>	H.264, MJPEG
<b>Video Stream</b>	Dual streams from H.264 or MJPEG

## Specifications: Vandal Proof IP Dome (Part 1)

<b>Frame Rate</b>	GV-VD120D GV-VD121D GV-VD122D GV-VD123D GV-VD1500	30 fps at 1280 x 1024
	GV-VD220D GV-VD221D GV-VD222D GV-VD223D GV-VD2400 GV-VD2500	30 fps at 1920 x 1080
	GV-VD320D GV-VD321D GV-VD322D GV-VD323D GV-VD3400	20 fps at 2048 x 1536
<b>Image Setting</b>		Brightness, Contrast, Saturation, Sharpness, Gamma, White Balance, Flicker-less, Image Orientation, Backlight Compensation, D/N Sensitivity, Shutter Speed, WDR, Defog, Super Low Lux
<b>Audio Compression</b>		G.711, AAC (Optional)
<b>Audio Support</b>		Two-Way Audio
<b>Sensor Input</b>		1 Input (Dry Contact)
<b>Alarm Output</b>		1 Output (200mA 5V DC)
<p><b>Note:</b></p> <ol style="list-style-type: none"> <li>1. The frame rate and performance may vary depending on the number of connections and data bitrates (different scenes).</li> <li>2. The Super Low Lux adjustment (Image Settings) is only available for GV-VD1500 / 2500.</li> </ol>		

## Video Resolution

<b>GV-VD120D</b> <b>GV-VD121D</b> <b>GV-VD122D</b> <b>GV-VD123D</b> <b>GV-VD1500</b>	<b>Main Stream</b>	<b>4:3</b>	1280 x 960, 640 x 480, 320 x 240
		<b>16:9</b>	1280 x 720, 640 x 360, 448 x 252
		<b>5:4</b>	1280 x 1024, 640 x 512, 320 x 256
	<b>Sub Stream</b>	<b>4:3</b>	640 x 480, 320 x 240
		<b>16:9</b>	640 x 360, 448 x 252
		<b>5:4</b>	640 x 512, 320 x 256
<b>GV-VD220D</b> <b>GV-VD221D</b> <b>GV-VD222D</b> <b>GV-VD223D</b> <b>GV-VD2400</b> <b>GV-VD2500</b>	<b>Main Stream</b>	<b>4:3</b>	1600 x 1200, 1280 x 960, 640 x 480, 320 x 240
		<b>16:9</b>	1920 x 1080, 1280 x 720, 640 x 360, 448 x 252
		<b>5:4</b>	1280 x 1024, 640 x 512, 320 x 256
	<b>Sub Stream</b>	<b>4:3</b>	640 x 480, 320 x 240
		<b>16:9</b>	640 x 360, 448 x 252
		<b>5:4</b>	640 x 512, 320 x 256
<b>GV-VD320D</b> <b>GV-VD321D</b> <b>GV-VD322D</b> <b>GV-VD323D</b> <b>GV-VD3400</b>	<b>Main Stream</b>	<b>4:3</b>	2048 x 1536, 1600 x 1200, 1280 x 960, 640 x 480, 320 x 240
		<b>16:9</b>	1920 x 1080, 1280 x 720, 640 x 360, 448 x 252
		<b>5:4</b>	1280 x 1024, 640 x 512, 320 x 256
	<b>Sub Stream</b>	<b>4:3</b>	640 x 480, 320 x 240
		<b>16:9</b>	640 x 360, 448 x 252
		<b>5:4</b>	640 x 512, 320 x 256

## Specifications: Vandal Proof IP Dome (Part 1)

### Network

<b>Interface</b>	10/100 Ethernet
<b>Protocol</b>	DHCP, DynDNS, FTP, HTTP, HTTPS, NTP, ONVIF (Profile S), PSIA, QoS (DSCP), RTSP, SNMP, SMTP, TCP, UDP, UPnP, 3GPP/ISMA

### Mechanical

<b>Camera Angle Adjustment</b>	<b>Pan</b>	0° ~ 350°
	<b>Tilt</b>	10° ~ 90°
	<b>Rotate</b>	0° ~ 340°
<b>Temperature Detector</b>		Yes
<b>Connectors</b>	<b>Power</b>	2-pin terminal block, PoE
	<b>Ethernet</b>	Ethernet (10/100 Base-T), RJ-45 cable
	<b>Audio</b>	1 In (RCA female for microphone) 1 Out (RCA female for speaker)
	<b>Digital I/O</b>	I/O Wires
	<b>Local Storage</b>	Micro SD card slot (SD/SDHC, version 2.0, Class 10)
<b>TV-Out</b>		BNC connector (640 x 480 resolution)
<b>LED Indicator</b>		2 LEDs: Power, Status
<b>Note:</b>		
1. SDXC and UHS-I card types are not supported.		
2. The TV-Out function only works in 640 x 480 resolution. For TV-Out to work properly, you must set the video resolution to 1280 x 1024 or lower. If both streams are enabled, the Sub Stream must be set to 640 x 480.		

## General

<b>Environment Temperature</b>		-30°C ~ 50°C (-22°F ~ 122°F)
<b>Humidity</b>		10% to 90% (no condensation)
<b>Power Source</b>		12V DC / 24V AC / PoE
<b>Max. Power Consumption</b>		12 W
<b>Dimensions</b>	<b>Camera Body</b>	ø165 x 125 mm (6.49" x 4.92")
	<b>Cable Length</b>	1 m (3.28 ft)
	<b>Cable Diameter</b>	ø16.7 mm (0.66")
	<b>Max. Connector Diameter</b>	ø16.7 mm (0.66")
<b>Weight</b>		1.7 kg (3.75 lb)
<b>Ingress Protection</b>		IP67
<b>Vandal Resistance</b>	GV-VD120D GV-VD121D GV-VD1500 GV-VD220D GV-VD221D GV-VD320D GV-VD321D GV-VD2400 GV-VD2500 GV-VD3400	IK10+
	GV-VD122D GV-VD123D GV-VD222D GV-VD223D GV-VD322D GV-VD323D	IK7
<b>Regulatory</b>	GV-VD1500 GV-VD2500	CE, FCC, RCM, RoHS compliant

## Specifications: Vandal Proof IP Dome (Part 1)

### Power over Ethernet

<b>PoE Standard</b>	IEEE 802.3af Power over Ethernet / PD
<b>PoE Power Supply Type</b>	End-Span
<b>PoE Power Output</b>	Per Port 48V DC, 350mA. Max. 15.4 watts

### Web Interface

<b>Installation Management</b>	Web-based configuration
<b>Maintenance</b>	Firmware upgrade through Web Browser or Utility
<b>Access from Web Browser</b>	Camera live view, video recording, change video quality, bandwidth control, image snapshot, digital I/O control, audio, Picture in Picture, Picture and Picture, Privacy Mask, Visual Automation, Tampering Alarm, Text Overlay, Digital PTZ
<b>Language</b>	Arabic / Bulgarian / Czech / Danish / Dutch / English / Finnish / French / German / Greek / Hebrew / Hungarian / Indonesian / Italian /Japanese / Lithuanian / Norwegian / Persian / Polish / Portuguese / Romanian / Russian / Serbian / Simplified Chinese / Slovakian / Slovenian / Spanish / Swedish / Thai / Traditional Chinese / Turkish

## Application

<b>Network Storage</b>	GV-NVR, GV-System, GV-Backup Center, GV-Recording Server
<b>Smart Device Access</b>	GV-Eye for Android smartphone, tablet, iPhone, and iPod Touch; GV-Eye HD for iPad
<b>Live Viewing</b>	IE, mobile phone
<b>CMS Server support</b>	GV-Control Center, GV-Center V2, GV-VSM
<b>Note:</b> GV-Backup Center, GV-Video Gateway and GV-Recording Server are only supported for V1.03 or later.	

All specifications are subject to change without prior notice.

# Specifications: Vandal Proof IP Dome (Part 2)

This section details the specifications on **GV-VD1530 / 1540 / 1540-E / 2430 / 2440 / 2440-E / 2530 / 2540 / 2540-E / 3430 / 3440 / 3440-E / 5340 / 5340-E**.

## Camera

Image Sensor	GV-VD1530 GV-VD1540	1/3" progressive scan super low lux CMOS	
	GV-VD2430 GV-VD2440 GV-VD3430 GV-VD3440	1/3.2" progressive scan CMOS	
	GV-VD2530 GV-VD2540 GV-VD2540-E	1/2.8" progressive scan super low lux CMOS	
	GV-VD5340 GV-VD5340-E	1/2.5" progressive scan CMOS	
	Picture Elements	GV-VD1530 GV-VD1540	1280 (H) x 1024 (V)



<b>Picture Elements</b>	GV-VD2430 GV-VD2440 GV-VD2530 GV-VD2540 GV-VD2540-E	1920 (H) x 1080 (V)	
	GV-VD3430 GV-VD3440	2048 (H) x 1536 (V)	
	GV-VD5340 GV-VD5340-E	2560 (H) x 1920 (V)	
<b>Minimum Illumination</b>	GV-VD1530 GV-VD1540	<b>Color</b>	0.01 Lux
		<b>B/W</b>	0.01 Lux
		<b>IR ON</b>	0 Lux
	GV-VD2430 GV-VD2440	<b>Color</b>	0.08 Lux
		<b>B/W</b>	0.05 Lux
		<b>IR ON</b>	0 Lux
	GV-VD2530 GV-VD2540 GV-VD2540-E	<b>Color</b>	0.02 Lux
		<b>B/W</b>	0.02 Lux
		<b>IR ON</b>	0 Lux
	GV-VD3430 GV-VD3440	<b>Color</b>	0.08 Lux
		<b>B/W</b>	0.05 Lux
		<b>IR ON</b>	0 Lux
GV-VD5340 GV-VD5340-E	<b>Color</b>	0.15 Lux	
	<b>B/W</b>	0.10 Lux	
	<b>IR ON</b>	0 Lux	
<b>Shutter Speed</b>		Automatic, Manual (1/5 ~ 1/8000 sec)	

## Specifications: Vandal Proof IP Dome (Part 2)

<b>White Balance</b>		Automatic, Manual (2800K ~ 8500K)
<b>Gain Control</b>		Automatic
<b>S/N Ratio</b>	GV-VD1530 GV-VD1540	55 dB
	GV-VD2430 GV-VD2440 GV-VD3430 GV-VD3440	47 dB
	GV-VD2530 GV-VD2540 GV-VD2540-E	52 dB
	GV-VD5340 GV-VD5340-E	45 dB
<b>WDR Pro</b>	GV-VD2430 GV-VD2440 GV-VD3430 GV-VD3440	Yes (with WDR sensor)
<b>WDR</b>		Yes

### Lens

<b>Megapixel</b>	Yes
<b>Day/Night</b>	Yes (with removable IR-cut filter)

<b>Lens Type</b>	GV-VD1530 GV-VD2430 GV-VD2530 GV-VD3430	Varifocal lens
	GV-VD1540 GV-VD2440 GV-VD2540 GV-VD2540-E GV-VD3440 GV-VD5340 GV-VD5340-E	Motorized varifocal lens
<b>Focal Length</b>	GV-VD1530 GV-VD2430 GV-VD2530 GV-VD3430 GV-VD1540 GV-VD2440 GV-VD2540 GV-VD2540-E GV-VD3440	3 ~ 9 mm
	GV-VD5340 GV-VD5340-E	3.3 ~ 9 mm
<b>Maximum Aperture</b>		F/1.2
<b>Mount</b>		∅ 14 mm
<b>Image Format</b>		1/2.7"

## Specifications: Vandal Proof IP Dome (Part 2)

<b>Horizontal FOV</b>	GV-VD1530 GV-VD1540		90° ~ 32°	
	GV-VD2430 GV-VD2440		82° ~ 30°	
	GV-VD2530 GV-VD2540 GV-VD2540-E		103° ~ 36°	
	GV-VD3430 GV-VD3440		86° ~ 31°	
	GV-VD5340 GV-VD5340-E		100° ~ 39°	
	<b>Operation</b>	GV-VD1530 GV-VD2430 GV-VD2530 GV-VD3430	<b>Focus</b>	Manual (w/lock)
		<b>Zoom</b>	Manual (w/lock)	
		<b>Iris</b>	DC drive	
GV-VD1540 GV-VD2440 GV-VD2540 GV-VD2540-E		<b>Focus</b>	Auto Focus	
		<b>Zoom</b>	3x Optical Zoom	
GV-VD3440 GV-VD5340 GV-VD5340-E		<b>Iris</b>	DC drive	
<b>High Power IR LED Quantity</b>			6 IR LEDs	
<b>Max. IR Distance</b>		GV-VD1530 GV-VD1540		30 m (98.4 ft)

<b>Max. IR Distance</b>	GV-VD2430 GV-VD2440 GV-VD3430 GV-VD3440 GV-VD5340 GV-VD5340-E	20 m (65.6 ft)
	GV-VD2530 GV-VD2540 GV-VD2540-E	25 m (82.0 ft)
<b>Max. Torque (Focus / Zoom Screws)</b>	GV-VD1530 GV-VD2430 GV-VD2530 GV-VD3430	0.049 N.m

## Operation

<b>Video Compression</b>		H.264, MJPEG
<b>Video Stream</b>		Dual streams from H.264 or MJPEG
<b>Frame Rate</b>	GV-VD1530 GV-VD1540	30 fps at 1280 x 1024
	GV-VD2430 GV-VD2440 GV-VD2530 GV-VD2540 GV-VD2540-E	30 fps at 1920 x 1080
	GV-VD3430 GV-VD3440	20 fps at 2048 x 1536
	GV-VD5340	10 fps at 2560 x 1920

## Specifications: Vandal Proof IP Dome (Part 2)

	<b>GV-VD5340-E</b>	
<b>Image Setting</b>		Brightness, Contrast, Saturation, Sharpness, Gamma, White Balance, Flicker-less, Image Orientation, Backlight Compensation, D/N Sensitivity, Shutter Speed, WDR, Defog, Super Low Lux, Zoom, Focus Change
<b>Audio Compression</b>		G.711, AAC (Optional)
<b>Audio Support</b>		Two-Way Audio
<b>Sensor Input</b>		1 Input (Dry Contact)
<b>Alarm Output</b>		1 Output (200mA 5V DC)
<p><b>Note:</b></p> <ol style="list-style-type: none"> <li>1. The frame rate and performance may vary depending on the number of connections and data bitrates (different scenes).</li> <li>2. The Super Low Lux adjustment (Image Settings) is only available for GV-VD1530 / 1540 / 1540-E / 2530 / 2540 / 2540-E.</li> <li>3. The Zoom and Focus Change adjustment (Image Settings) are only available for motorized varifocal models (GV-VD1540 / 1540-E / 2440 / 2440-E / 2540 / 2540-E / 3440 / 3440-E / 5340 / 5340-E).</li> </ol>		

## Video Resolution

GV-VD1530 GV-VD1540	Main Stream	4:3	1280 x 960, 640 x 480, 320 x 240
		16:9	1280 x 720, 640 x 360, 448 x 252
		5:4	1280 x 1024, 640 x 512, 320 x 256
	Sub Stream	4:3	640 x 480, 320 x 240
		16:9	640 x 360, 448 x 252
		5:4	640 x 512, 320 x 256
GV-VD2430 GV-VD2440 GV-VD2530 GV-VD2540 GV-VD2540-E	Main Stream	4:3	1600 x 1200, 1280 x 960, 640 x 480, 320 x 240
		16:9	1920 x 1080, 1280 x 720, 640 x 360, 448 x 252
		5:4	1280 x 1024, 640 x 512, 320 x 256
	Sub Stream	4:3	640 x 480, 320 x 240
		16:9	640 x 360, 448 x 252
		5:4	640 x 512, 320 x 256
GV-VD3430 GV-VD3440	Main Stream	4:3	2048 x 1536, 1600 x 1200, 1280 x 960, 640 x 480, 320 x 240
		16:9	1920 x 1080, 1280 x 720, 640 x 360, 448 x 252
		5:4	1280 x 1024, 640 x 512, 320 x 256
	Sub Stream	4:3	640 x 480, 320 x 240
		16:9	640 x 360, 448 x 252
		5:4	640 x 512, 320 x 256
GV-VD5340 GV-VD5340-E	Main Stream	4:3	2560 x 1920, 2048 x 1536, 1600 x 1200, 1280 x 960, 640 x 480, 320 x 240
		16:9	1920 x 1080, 1280 x 720
		5:4	1280 x 1024, 640 x 512, 320 x 256

## Specifications: Vandal Proof IP Dome (Part 2)

GV-VD5340 GV-VD5340-E	Sub Stream	4:3	640 x 480, 320 x 240
		16:9	640 x 360, 448 x 252
		5:4	640 x 512, 320 x 256

### Network

Interface	10/100 Ethernet
Protocol	DHCP, DynDNS, FTP, HTTP, HTTPS, NTP, ONVIF (Profile S), PSIA, QoS (DSCP), RTSP, SNMP, SMTP, TCP, UDP, UPnP, 3GPP/ISMA

### Mechanical

Temperature Detector		Yes
Camera Angle Adjustment	Pan	-90° ~ 90°
	Tilt	0° ~ 85°
	Rotate	0° ~ 350°
Connectors	Power	2-pin terminal block, PoE
	Ethernet	Ethernet (10/100 Base-T), RJ-45 cable
	Audio	1 In (3.5 mm phone jack for microphone) 1 Out (3.5 mm phone jack for speaker)
	Digital I/O	3-pin terminal block, pitch 2.5 mm (0.1")
	Local Storage	Micro SD card slot (SD/SDHC, version 2.0, Class 10)
	TV-Out	BNC connector (640 x 480 resolution)
LED Indicator		2 LEDs: Power, Status



**Note:**

- SDXC and UHS-I card types are not supported.
- The TV-Out function only works in 640 x 480 resolution. For TV-Out to work properly, you must set the video resolution to 1280 x 1024 or lower. If both streams are enabled, the Sub Stream must be set to 640 x 480.

## General

Environment Temperature	GV-VD1530 GV-VD2430	Start-up	-20°C ~ 50°C (-4°F ~ 122°F)
	GV-VD2530 GV-VD3430	Operation	-30°C ~ 50°C (-22°F ~ 122°F)
	GV-VD1540 GV-VD2440	Start-up	-20°C ~ 50°C (-4°F ~ 122°F)
	GV-VD2540 GV-VD3440 GV-VD5340	Operation	
	GV-VD2540-E GV-VD5340-E	Start-up	-40°C ~ 50°C (-40°F ~ 122°F)
		Operation	
	Heat On	GV-VD2540-E GV-VD5340-E	On (0°C / 32°F), Off (1°C / 33.8°F)

## Specifications: Vandal Proof IP Dome (Part 2)

<b>Fan</b>	GV-VD2540-E GV-VD5340-E	Constantly on
<b>Humidity</b>		10% to 90% (no condensation)
<b>Power Source</b>		12V DC / 24V AC / PoE
<b>Max. Power Consumption</b>	GV-VD1530 GV-VD2430 GV-VD2530 GV-VD3430	15.4 W
	GV-VD1540 GV-VD2440 GV-VD2540 GV-VD3440 GV-VD5340	22.48 W
	GV-VD5340-E	30 W
	<b>Dimensions</b>	

<b>Weight</b>	GV-VD1530 GV-VD2430 GV-VD2530 GV-VD3430	1.76 kg (3.88 lb)
	GV-VD1540 GV-VD2440 GV-VD2540 GV-VD3440 GV-VD5340 GV-VD5340-E	1.83 kg (4.03 lb)
<b>Ingress Protection</b>	IP67	
<b>Vandal Resistance</b>	IK10+	
<b>Regulatory</b>	CE, FCC, RCM, RoHS compliant	

## Power over Ethernet

<b>PoE Standard</b>	IEEE 802.3at Power over Ethernet / PD
<b>PoE Power Supply Type</b>	End-Span
<b>PoE Power Output</b>	Per Port 48V DC, 600 mA. Max. 30 watts

## Web Interface

<b>Installation Management</b>	Web-based configuration
<b>Maintenance</b>	Firmware upgrade through Web Browser or Utility

## Specifications: Vandal Proof IP Dome (Part 2)

<b>Access from Web Browser</b>	Camera live view, video recording, change video quality, bandwidth control, image snapshot, digital I/O control, audio, Picture in Picture, Picture and Picture, Privacy Mask, Visual Automation, Tampering Alarm, Text Overlay, Digital PTZ
<b>Language</b>	Arabic / Bulgarian / Czech / Danish / Dutch / English / Finnish / French / German / Greek / Hebrew / Hungarian / Indonesian / Italian / Japanese / Lithuanian / Norwegian / Persian / Polish / Portuguese / Romanian / Russian / Serbian / Simplified Chinese / Slovakian / Slovenian / Spanish / Swedish / Thai / Traditional Chinese / Turkish

### Application

<b>Network Storage</b>	GV-NVR, GV-System, GV-Backup Center, GV-Recording Server
<b>Smart Device Access</b>	GV-Eye for Android smartphone, tablet, iPhone, and iPod Touch; GV-Eye HD for iPad
<b>Live Viewing</b>	IE, mobile phone
<b>CMS Server support</b>	GV-Control Center, GV-Center V2, GV-VSM

All specifications are subject to change without prior notice.

# Specifications: Fixed IP Dome

## (Part 1)

This section details the specifications on **GV-FD120D / 220D / 320D**.

### Camera

<b>Image Sensor</b>	<b>GV-FD120D</b>	1/3" progressive scan low lux CMOS	
	<b>GV-FD220D</b> <b>GV-FD320D</b>	1/2.5" progressive scan CMOS	
<b>Picture Elements</b>	<b>GV-FD120D</b>	1280 (H) x 1024 (V)	
	<b>GV-FD220D</b>	1920 (H) x 1080 (V)	
	<b>GV-FD320D</b>	2048 (H) x 1536 (V)	
<b>Minimum Illumination</b>	<b>GV-FD120D</b>	<b>Color</b>	0.05 Lux
		<b>B/W</b>	0.03 Lux
		<b>IR ON</b>	0 Lux
	<b>GV-FD220D</b> <b>GV-FD320D</b>	<b>Color</b>	0.15 Lux
		<b>B/W</b>	0.10 Lux
		<b>IR ON</b>	0 Lux
<b>Shutter Speed</b>		Automatic, Manual (1/5 ~ 1/8000 sec)	
<b>White Balance</b>		Automatic, Manual (2800K ~ 8500K)	
<b>Gain Control</b>		Automatic	
<b>S/N Ratio</b>	<b>GV-FD120D</b>	50 dB	
	<b>GV-FD220D</b> <b>GV-FD320D</b>	45 dB	
<b>WDR</b>		Yes	

## Specifications: Fixed IP Dome (Part 1)

### Lens

<b>Megapixel</b>		Yes
<b>Day/Night</b>		Yes (with removable IR-cut filter)
<b>Lens Type</b>		Varifocal
<b>Focal Length</b>		3 ~ 9 mm
<b>Maximum Aperture</b>		F/1.3 ± 5%
<b>Mount</b>		∅ 14 mm
<b>Image Format</b>		1/3"
<b>Horizontal FOV</b>	<b>GV-FD120D</b>	86° ~ 32°
	<b>GV-FD220D</b>	82° ~ 30°
	<b>GV-FD320D</b>	86° ~ 31°
<b>Operation</b>		<b>Focus</b> Manual (w/lock)
		<b>Zoom</b> Manual (w/lock)
		<b>Iris</b> DC drive
<b>IR LED Quantity</b>		10 IR LEDs
<b>Max. IR Distance</b>		15 m (50 ft)
<b>Max. Torque (Focus / Zoom Screws)</b>		0.049 N.m

### Operation

<b>Video Compression</b>		H.264, MJPEG
<b>Video Stream</b>		Dual streams from H.264 or MJPEG
<b>Frame Rate</b>	<b>GV-FD120D</b>	30 fps at 1280 x 1024
	<b>GV-FD220D</b>	30 fps at 1920 x 1080
	<b>GV-FD320D</b>	20 fps at 2048 x 1536

<b>Image Setting</b>	Brightness, Contrast, Saturation, Sharpness, Gamma, White Balance, Flicker-less, Image Orientation, Shutter Speed, Backlight Compensation, D/N Sensitivity, WDR, Defog
<b>Audio Compression</b>	G.711, AAC (Optional)
<b>Audio Support</b>	Two-Way Audio
<b>Sensor Input</b>	1 Input (Dry Contact)
<b>Alarm Output</b>	1 Output (200mA 5V DC)
<b>Note:</b> The frame rate and performance may vary depending on the number of connections and data bitrates (different scenes).	

## Video Resolution

<b>GV-FD120D</b>	<b>Main Stream</b>	<b>4:3</b>	1280 x 960, 640 x 480, 320 x 240
		<b>16:9</b>	1280 x 720, 640 x 360, 448 x 252
		<b>5:4</b>	1280 x 1024, 640 x 512, 320 x 256
	<b>Sub Stream</b>	<b>4:3</b>	640 x 480, 320 x 240
		<b>16:9</b>	640 x 360, 448 x 252
		<b>5:4</b>	640 x 512, 320 x 256
<b>GV-FD220D</b>	<b>Main Stream</b>	<b>4:3</b>	1600 x 1200, 1280 x 960, 640 x 480, 320 x 240
		<b>16:9</b>	1920 x 1080, 1280 x 720, 640 x 360, 448 x 252
		<b>5:4</b>	1280 x 1024, 640 x 512, 320 x 256
	<b>Sub Stream</b>	<b>4:3</b>	640 x 480, 320 x 240
		<b>16:9</b>	640 x 360, 448 x 252, 640 x 360, 448 x 252
		<b>5:4</b>	640 x 512, 320 x 256, 640 x 512, 320 x 256

## Specifications: Fixed IP Dome (Part 1)

GV-FD320D	Main Stream	4:3	2048 x 1536, 1600 x 1200, 1280 x 960, 640 x 480, 320 x 240
		16:9	1920 x 1080, 1280 x 720, 640 x 360, 448 x 252
		5:4	1280 x 1024, 640 x 512, 320 x 256
	Sub Stream	4:3	640 x 480, 320 x 240
		16:9	640 x 360, 448 x 252
		5:4	640 x 512, 320 x 256

### Network

Interface	10/100 Ethernet
Protocol	DHCP, DynDNS, FTP, HTTP, HTTPS, NTP, ONVIF (Profile S), PSIA, QoS (DSCP), RTSP, SNMP, SMTP, TCP, UDP, UPnP, 3GPP/ISMA

### Mechanical

Camera Angle Adjustment	Pan	0° ~ 350°
	Tilt	10° ~ 90°
	Rotate	0° ~ 340°
Temperature Detector		Yes
Connectors	Power	2-pin terminal block, PoE
	Ethernet	Ethernet (10/100 Base-T), RJ-45 cable
	Audio	1 In (microphone phone jack, 3.5 mm / 0.14") 1 Out (Stereo phone jack, 3.5 mm / 0.14")
	Digital I/O	3-pin terminal block, pitch 2.5 mm / 0.1"
	Local Storage	Micro SD card slot (SD/SDHC, version 2.0, Class 10)



<b>Connectors</b>	<b>TV-Out</b>	BNC connector (640 x 480 resolution)
<b>LED Indicator</b>		2 LEDs: Power, Status
<p><b>Note:</b></p> <ol style="list-style-type: none"> <li>SDXC and UHS-I card types are not supported.</li> <li>The TV-Out function only works in 640 x 480 resolution. For TV-Out to work properly, you must set the video resolution to 1280 x 1024 or lower. If both streams are enabled, the Sub Stream must be set to 640 x 480.</li> </ol>		

## General

<b>Environment Temperature</b>	0°C ~ 50°C (32°F ~ 122°F)
<b>Humidity</b>	10% to 90% (no condensation)
<b>Power Source</b>	12V DC / 24V AC / PoE
<b>Max. Power Consumption</b>	12 W
<b>Dimensions (L X W X H)</b>	155 x 110 mm (6.1" x 4.33")
<b>Weight</b>	580 g (1.28 lb)
<b>Vandal Resistance</b>	IK7
<b>Regulatory</b>	CE, FCC, C-Tick, RoHS compliant

## Power over Ethernet

<b>PoE Standard</b>	IEEE 802.3af Power over Ethernet / PD
<b>PoE Power Supply Type</b>	End-Span
<b>PoE Power Output</b>	Per Port 48V DC, 350mA. Max. 15.4 watts

## Web Interface

<b>Installation Management</b>	Web-based configuration
--------------------------------	-------------------------

## Specifications: Fixed IP Dome (Part 1)

<b>Maintenance</b>	Firmware upgrade through Web Browser or Utility
<b>Access from Web Browser</b>	Camera live view, video recording, change video quality, bandwidth control, image snapshot, digital I/O control, audio, Picture in Picture, Picture and Picture, Privacy Mask, Visual Automation, Tampering Alarm, Text Overlay, Digital PTZ
<b>Language</b>	Arabic / Bulgarian / Czech / Danish / Dutch / English / Finnish / French / German / Greek / Hebrew / Hungarian / Indonesian / Italian / Japanese / Lithuanian / Norwegian / Persian / Polish / Portuguese / Romanian / Russian / Serbian / Simplified Chinese / Slovakian / Slovenian / Spanish / Swedish / Thai / Traditional Chinese / Turkish

### Application

<b>Network Storage</b>	GV-NVR, GV-System, GV-Backup Center, GV-Recording Server
<b>Smart Device Access</b>	GV-Eye for Android smartphone, tablet, iPhone, and iPod Touch; GV-Eye HD for iPad
<b>Live Viewing</b>	IE, mobile phone
<b>CMS Server support</b>	GV-Control Center, GV-Center V2, GV-VSM
<b>Note:</b> For the GV-Backup Center and GV-Recording Server supported firmware versions, please see <i>Appendix D</i> .	

All specifications are subject to change without prior notice.

# Specifications: Fixed IP Dome

## (Part 2)

This section details the specifications on **GV-FD1200 / 1210 / 1500 / 1510 / 2400 / 2410 / 2500 / 2510 / 3400 / 3410 / 5300**.

### Camera

<b>Image Sensor</b>	<b>GV-FD1200</b> <b>GV-FD1210</b>	1/3" progressive scan low lux CMOS
	<b>GV-FD1500</b> <b>GV-FD1510</b>	1/3" progressive scan super low lux CMOS
	<b>GV-FD2500</b> <b>GV-FD2510</b>	1/2.8" progressive scan super low lux CMOS
	<b>GV-FD2400</b> <b>GV-FD2410</b> <b>GV-FD3400</b> <b>GV-FD3410</b>	1/3.2" progressive scan CMOS
	<b>GV-FD5300</b>	1/2.5" progressive scan CMOS
<b>Picture Elements</b>	<b>GV-FD1200</b> <b>GV-FD1210</b> <b>GV-FD1500</b> <b>GV-FD1510</b>	1280 (H) x 1024 (V)
	<b>GV-FD2400</b> <b>GV-FD2410</b> <b>GV-FD2500</b> <b>GV-FD2510</b>	1920 (H) x 1080 (V)

## Specifications: Fixed IP Dome (Part 2)

<b>Picture Elements</b>	<b>GV-FD3400</b> <b>GV-FD3410</b>		2048 (H) x 1536 (V)
	<b>GV-FD5300</b>		2560 (H) x 1920 (V)
<b>Minimum Illumination</b>	<b>GV-FD1200</b> <b>GV-FD1210</b>	<b>Color</b>	0.05
		<b>B/W</b>	0.03 Lux
		<b>IR ON</b>	0 Lux
	<b>GV-FD1500</b> <b>GV-FD1510</b>	<b>Color</b>	0.01 Lux
		<b>B/W</b>	0.01 Lux
		<b>IR ON</b>	0 Lux
	<b>GV-FD2500</b> <b>GV-FD2510</b>	<b>Color</b>	0.02 Lux
		<b>B/W</b>	0.02 Lux
		<b>IR ON</b>	0 Lux
	<b>GV-FD2400</b> <b>GV-FD2410</b> <b>GV-FD3400</b> <b>GV-FD3410</b>	<b>Color</b>	0.08 Lux
		<b>B/W</b>	0.05 Lux
		<b>IR ON</b>	0 Lux
	<b>GV-FD5300</b>	<b>Color</b>	0.15 Lux
		<b>B/W</b>	0.10 Lux
		<b>IR ON</b>	0 Lux
<b>Shutter Speed</b>		Automatic, Manual (1/5 ~ 1/8000 sec)	
<b>White Balance</b>		Automatic, Manual (2800K ~ 8500K)	
<b>Gain Control</b>		Automatic	
<b>S/N Ratio</b>	<b>GV-FD1200</b> <b>GV-FD1210</b>	50 dB	
	<b>GV-FD1500</b> <b>GV-FD1510</b>	55 dB	

<b>S/N Ratio</b>	<b>GV-FD2500</b> <b>GV-FD2510</b>	52 dB
	<b>GV-FD2400</b> <b>GV-FD2410</b> <b>GV-FD3400</b> <b>GV-FD3410</b>	47 dB
	<b>GV-FD5300</b>	45 dB
	<b>GV-FD2400</b> <b>GV-FD2410</b> <b>GV-FD3400</b> <b>GV-FD3410</b>	Yes
<b>WDR</b>		Yes

## Lens

<b>Megapixel</b>		Yes
<b>Day/Night</b>		Yes (with removable IR-cut filter)
<b>Lens Type</b>	<b>GV-FD1200</b> <b>GV-FD1500</b> <b>GV-FD2400</b> <b>GV-FD2500</b> <b>GV-FD3400</b> <b>GV-FD5300</b>	Varifocal
	<b>GV-FD1210</b> <b>GV-FD1510</b> <b>GV-FD2410</b> <b>GV-FD2510</b> <b>GV-FD3410</b>	Motorized varifocal

## Specifications: Fixed IP Dome (Part 2)

<b>Focal Length</b>	GV-FD1200	3 ~ 9 mm
	GV-FD1210	
	GV-FD1500	
	GV-FD1510	
	GV-FD2400	
	GV-FD2410	
	GV-FD2500	
	GV-FD2510	
	GV-FD3400	
	GV-FD3410	
	GV-FD5300	4.5 ~ 10 mm
<b>Maximum Aperture</b>	GV-FD1200	F/1.2
	GV-FD1210	
	GV-FD1500	
	GV-FD1510	
	GV-FD2400	
	GV-FD2410	
	GV-FD2500	
	GV-FD2510	
	GV-FD3410	
	GV-FD3400	
	GV-FD5300	F/1.6

<b>Mount</b>	GV-FD1200	ø 14 mm
	GV-FD1210	
	GV-FD1500	
	GV-FD1510	
	GV-FD2400	
	GV-FD2410	
	GV-FD2500	
	GV-FD2510	
	GV-FD3400	
	GV-FD3410	
	GV-FD5300	CS Mount
<b>Image Format</b>	GV-FD1200	1/2.7"
	GV-FD1210	
	GV-FD1500	
	GV-FD1510	
	GV-FD2400	
	GV-FD2410	
	GV-FD2500	
	GV-FD2510	
	GV-FD3400	
	GV-FD3410	
	GV-FD5300	1/2.5"

## Specifications: Fixed IP Dome (Part 2)

<b>Horizontal FOV</b>	<b>GV-FD1200</b> <b>GV-FD1210</b>	86° ~ 32°	
	<b>GV-FD1500</b> <b>GV-FD1510</b>	90° ~ 32°	
	<b>GV-FD2400</b> <b>GV-FD2410</b>	82° ~ 30°	
	<b>GV-FD2500</b> <b>GV-FD2510</b>	103° ~ 36°	
	<b>GV-FD3400</b> <b>GV-FD3410</b>	86° ~ 31°	
	<b>GV-FD5300</b>	70° ~ 34°	
<b>Operation</b>	<b>GV-FD1200</b> <b>GV-FD1500</b>	<b>Focus</b>	Manual (w/lock)
	<b>GV-FD2400</b> <b>GV-FD2500</b>	<b>Zoom</b>	Manual (w/lock)
	<b>GV-FD3400</b>	<b>Iris</b>	DC drive
	<b>GV-FD1210</b>	<b>Focus</b>	Auto Focus
	<b>GV-FD1510</b>	<b>Zoom</b>	3X Optical Zoom
	<b>GV-FD2410</b> <b>GV-FD2510</b> <b>GV-FD3410</b>	<b>Iris</b>	DC drive
	<b>GV-FD5300</b>	<b>Focus</b>	Manual (w/lock)
		<b>Zoom</b>	
		<b>Iris</b>	
<b>IR LED Quantity</b>		10 IR LEDs	



<b>Max. IR Distance</b>	GV-FD1200 GV-FD1210	15 m (50 ft)
	GV-FD1500 GV-FD1510 GV-FD2400 GV-FD2410 GV-FD3400 GV-FD3410 GV-FD2500 GV-FD2510	30 m (98.4 ft)
	GV-FD5300	25 m (82 ft)
	GV-FD1200 GV-FD1500 GV-FD2400 GV-FD2500 GV-FD3400 GV-FD5300	0.049 N.m

## Operation

<b>Video Compression</b>		H.264, MJPEG
<b>Video Stream</b>		Dual streams from H.264 or MJPEG
<b>Frame Rate</b>	GV-FD1200 GV-FD1210 GV-FD1500 GV-FD1510	30 fps at 1280 x 1024
	GV-FD2400 GV-FD2410 GV-FD2500 GV-FD2510	30 fps at 1920 x 1080

## Specifications: Fixed IP Dome (Part 2)

	<b>GV-FD3400</b>	20 fps at 2048 x 1536
	<b>GV-FD3410</b>	
	<b>GV-FD5300</b>	10 fps at 2560 x 1920

<b>Image Setting</b>	Brightness, Contrast, Saturation, Sharpness, Gamma, White Balance, Flicker-less, Image Orientation, Shutter Speed, Backlight Compensation, D/N Sensitivity, WDR, Defog, Super Low Lux
<b>Audio Compression</b>	G.711, AAC (Optional)
<b>Audio Support</b>	Two-Way Audio
<b>Sensor Input</b>	1 Input (Dry Contact)
<b>Alarm Output</b>	1 Output (200mA 5V DC)
<b>Note:</b>	
<ol style="list-style-type: none"> <li>The frame rate and performance may vary depending on the number of connections and data bitrates (different scenes).</li> <li>The super low lux adjustment (Image Settings) is only available for GV-FD1500 / 1510 / 2500 / 2510.</li> </ol>	

### Video Resolution

<b>GV-FD1200</b> <b>GV-FD1210</b> <b>GV-FD1500</b> <b>GV-FD1510</b>	<b>Main Stream</b>	<b>4:3</b>	1280 x 960, 640 x 480, 320 x 240
		<b>16:9</b>	1280 x 720, 640 x 360, 448 x 252
		<b>5:4</b>	1280 x 1024, 640 x 512, 320 x 256
	<b>Sub Stream</b>	<b>4:3</b>	640 x 480, 320 x 240
		<b>16:9</b>	640 x 360, 448 x 252
		<b>5:4</b>	640 x 512, 320 x 256
<b>GV-FD2400</b>	<b>Main</b>	<b>4:3</b>	1600 x 1200, 1280 x 960,

GV-FD2410 GV-FD2500 GV-FD2510	Stream		640 x 480, 320 x 240
		16:9	1920 x 1080, 1280 x 720, 640 x 360, 448 x 252
		5:4	1280 x 1024, 640 x 512, 320 x 256
GV-FD2400 GV-FD2410 GV-FD2500 GV-FD2510	Sub Stream	4:3	640 x 480, 320 x 240
		16:9	640 x 360, 448 x 252
		5:4	640 x 512, 320 x 256
GV-FD3400 GV-FD3410	Main Stream	4:3	2048 x 1536, 1600 x 1200, 1280 x 960, 640 x 480, 320 x 240
		16:9	1920 x 1080, 1280 x 720, 640 x 360, 448 x 252
		5:4	1280 x 1024, 640 x 512, 320 x 256
	Sub Stream	4:3	640 x 480, 320 x 240
		16:9	640 x 360, 448 x 252
		5:4	640 x 512, 320 x 256
GV-FD5300	Main Stream	4:3	2560 x 1920, 2048 x 1536, 1600 x 1200, 1280 x 960, 640 x 480, 320 x 240
		16:9	1920 x 1080, 1280 x 720, 640 x 360, 448 x 252
		5:4	1280 x 1024, 640 x 512, 320 x 256
	Sub Stream	4:3	640 x 480, 320 x 240
		16:9	640 x 360, 448 x 252
		5:4	640 x 512, 320 x 256

## Specifications: Fixed IP Dome (Part 2)

### Network

<b>Interface</b>	10/100 Ethernet
<b>Protocol</b>	DHCP, DynDNS, FTP, HTTP, HTTPS, NTP, ONVIF (Profile S), PSIA, QoS (DSCP), RTSP, SNMP, SMTP, TCP, UDP, UPnP, 3GPP/ISMA

### Mechanical

<b>Camera Angle Adjustment</b>	<b>Pan</b>	0° ~ 350°
	<b>Tilt</b>	10° ~ 90°
	<b>Rotate</b>	0° ~ 340°
<b>Temperature Detector</b>		Yes
<b>Connectors</b>	<b>Power</b>	2-pin terminal block, PoE
	<b>Ethernet</b>	Ethernet (10/100 Base-T), RJ-45 cable
	<b>Audio</b>	1 In (microphone phone jack, 3.5 mm / 0.14") 1 Out (Stereo phone jack, 3.5 mm / 0.14")
	<b>Digital I/O</b>	3-pin terminal block, pitch 2.5 mm / 0.1"
	<b>Local Storage</b>	Micro SD card slot (SD/SDHC, version 2.0 only, Class 10)
<b>TV-Out</b>	BNC connector (640 x 480 resolution)	
<b>LED Indicator</b>		2 LEDs: Power, Status
<b>Note:</b> <ol style="list-style-type: none"><li>SDXC and UHS-I card types are not supported.</li><li>The TV-Out function only works in 640 x 480 resolution. For TV-Out to work properly, you must set the video resolution to 1280 x 1024 or lower. If both streams are enabled, the Sub Stream must be set to 640 x 480.</li></ol>		

## General

<b>Environment Temperature</b>		0°C ~ 50°C (32°F ~ 122°F)
<b>Humidity</b>		10% to 90% (no condensation)
<b>Power Source</b>		12V DC / 24V AC / PoE
<b>Max. Power Consumption</b>		12 W
<b>Dimensions (L X W X H)</b>		155 x 110 mm (6.1" x 4.33")
<b>Weight</b>		580 g (1.28 lb)
<b>Vandal Resistance</b>		IK7
<b>Regulatory</b>	GV-FD1200 GV-FD1210 GV-FD2400 GV-FD2410 GV-FD3400 GV-FD3410	CE, FCC, C-Tick, RoHS compliant
	GV-FD1500 GV-FD1510 GV-FD2500 GV-FD2510	CE, FCC, RCM, RoHS compliant

## Power over Ethernet

<b>PoE Standard</b>	IEEE 802.3af Power over Ethernet / PD
<b>PoE Power Supply Type</b>	End-Span
<b>PoE Power Output</b>	Per Port 48V DC, 350mA. Max. 15.4 watts

## Specifications: Fixed IP Dome (Part 2)

### Web Interface

<b>Installation Management</b>	Web-based configuration
<b>Maintenance</b>	Firmware upgrade through Web Browser or Utility
<b>Access from Web Browser</b>	Camera live view, video recording, change video quality, bandwidth control, image snapshot, digital I/O control, audio, Picture in Picture, Picture and Picture, Privacy Mask, Visual Automation, Tampering Alarm, Text Overlay, Digital PTZ
<b>Language</b>	Arabic / Bulgarian / Czech / Danish / Dutch / English / Finnish / French / German / Greek / Hebrew / Hungarian / Indonesian / Italian / Japanese / Lithuanian / Norwegian / Persian / Polish / Portuguese / Romanian / Russian / Serbian / Simplified Chinese / Slovakian / Slovenian / Spanish / Swedish / Thai / Traditional Chinese / Turkish

### Application

<b>Network Storage</b>	GV-NVR, GV-System, GV-Backup Center, GV-Recording Server
<b>Smart Device Access</b>	GV-Eye for Android smartphone, tablet, iPhone, and iPod Touch; GV-Eye HD for iPad
<b>Live Viewing</b>	IE, mobile phone
<b>CMS Server support</b>	GV-Control Center, GV-Center V2, GV-VSM
<b>Note:</b> For the GV-Backup Center and GV-Recording Server supported firmware versions, please see <i>Appendix D</i> .	

All specifications are subject to change without prior notice.

## Specifications: Cube Camera

### Camera

<b>Image Sensor</b>		1/2.5" progressive scan CMOS
<b>Picture Elements</b>	<b>GV-CB120</b> <b>GV-CBW120</b>	1280 (H) x 1024 (V)
	<b>GV-CB220</b> <b>GV-CBW220</b>	1920 (H) x 1080 (V)
<b>Minimum Illumination</b>	<b>Color</b>	0.15 Lux
	<b>B/W</b>	0.10 Lux
<b>Shutter Speed</b>		Automatic, Manual (1/5 ~ 1/8000 sec)
<b>White Balance</b>		Automatic, Manual (2800 ~ 8500K)
<b>Gain Control</b>		Automatic
<b>S/N Ratio</b>	<b>GV-CB120</b>	45 dB
	<b>GV-CB220</b>	
	<b>GV-CBW120</b>	
	<b>GV-CBW220</b>	
<b>WDR</b>		Yes

### Lens

<b>Megapixel</b>	Yes
<b>Day/Night</b>	Yes (electronic)
<b>Lens Type</b>	Fixed
<b>Focal Length</b>	3.35 mm
<b>Maximum Aperture</b>	F/2.4
<b>Mount</b>	M12 mm

## Specifications: Cube Camera

<b>Image Format</b>		1/3"
<b>Horizontal FOV</b>	<b>GV-CB120</b> <b>GV-CBW120</b>	67°
	<b>GV-CB220</b> <b>GV-CBW220</b>	77°
<b>Operation (Focus / Zoom / Iris)</b>		Fixed

### Operation

<b>Video Compression</b>		H.264, MJPEG
<b>Video Stream</b>		Dual streams from H.264 or MJPEG
<b>Frame Rate</b>	<b>GV-CB120</b> <b>GV-CBW120</b>	30 fps at 1280 x 1024
	<b>GV-CB220</b> <b>GV-CBW220</b>	30 fps at 1920 x 1080
<b>Image Setting</b>		Brightness, Contrast, Saturation, Sharpness, Gamma, White Balance, Flicker-less, Image Orientation, Shutter Speed, Backlight Compensation, WDR, Defog
<b>Audio Compression</b>		G.711, AAC (Optional)
<b>Audio Support</b>		Two-Way Audio
<b>Note:</b> The frame rate and performance may vary depending on the number of connections and data bitrates (different scenes).		



## Video Resolution

<b>GV-CB120</b> <b>GV-CBW120</b>	<b>Main Stream</b>	<b>4:3</b>	1280 x 960, 640 x 480, 320 x 240
		<b>16:9</b>	1280 x 720, 640 x 360, 448 x 252
		<b>5:4</b>	1280 x 1024, 640 x 512, 320 x 256
	<b>Sub Stream</b>	<b>4:3</b>	640 x 480, 320 x 240
		<b>16:9</b>	640 x 360, 448 x 252
		<b>5:4</b>	640 x 512, 320 x 256
<b>GV-CB220</b> <b>GV-CBW220</b>	<b>Main Stream</b>	<b>4:3</b>	1600 x 1200, 1280 x 960, 640 x 480, 320 x 240
		<b>16:9</b>	1920 x 1080, 1280 x 720, 640 x 360, 448 x 252
		<b>5:4</b>	1280 x 1024, 640 x 512, 320 x 256
	<b>Sub Stream</b>	<b>4:3</b>	640 x 480, 320 x 240
		<b>16:9</b>	640 x 360, 448 x 252
		<b>5:4</b>	640 x 512, 320 x 256

## Network

<b>Interface</b>	10/100 Ethernet
<b>Protocol</b>	DHCP, DynDNS, FTP, HTTP, HTTPS, NTP, ONVIF (Profile S), PSIA, QoS (DSCP), RTSP, SNMP, SMTP, TCP, UDP, UPnP, 3GPP/ISMA

## Network (for GV-CBW120 / 220 only)

<b>Wireless LAN</b>	IEEE 802.11 b/g/n
<b>Antenna Type</b>	Built-in
<b>Security</b>	WEP, WPA-PSK(TKIP), WPA-PSK(AES), WPA2-PSK(TKIP), WPA2-PSK(AES)
<b>Note:</b> The signal range and data throughput may vary depending on the network conditions and environmental factors.	

## Specifications: Cube Camera

### Mechanical

<b>Temperature Detector</b>		No
<b>Connectors</b>	<b>Power</b>	DC Jack
	<b>Ethernet</b>	Ethernet (10/100 Base-T), RJ-45 cable
	<b>Audio</b>	Built-in speaker & microphone
	<b>Local Storage</b>	Micro SD card slot (SD/SDHC, version 2.0 only, Class 10)
<b>LED Indicator</b>		2 LEDs: Status, LAN
<b>Note:</b> SDXC and UHS-I card types are not supported.		

### General

<b>Environment Temperature</b>	<b>GV-CB120</b> <b>GV-CB220</b>	0°C ~ 50°C (32°F ~ 122°F)
	<b>GV-CBW120</b> <b>GV-CBW220</b>	0°C ~ 40°C (32°F ~ 104°F)
<b>Humidity</b>		10% to 90% (no condensation)
<b>Power Source</b>		5V DC
<b>Max. Power Consumption</b>		3.2 W
<b>Dimensions (L X W X H)</b>		60 x 84.8 x 39 mm (2.36" x 3.34" x 1.54")
<b>Weight</b>	<b>GV-CB120</b> <b>GV-CB220</b>	80 g (0.18 lb)
	<b>GV-CBW120</b> <b>GV-CBW220</b>	70 g (0.15 lb)
<b>Regulatory</b>		CE, FCC, C-Tick, RoHS compliant
<b>IMPORTANT:</b> Be sure to use the GeoVision power adapter to power up the camera. To use your own power cable, make sure you look up the power source value indicated at the camera's back panel.		

## Web Interface

<b>Installation Management</b>	Web-based configuration
<b>Maintenance</b>	Firmware upgrade through Web Browser or Utility
<b>Access from Web Browser</b>	Camera live view, video recording, change video quality, bandwidth control, image snapshot, , audio, Picture in Picture, Picture and Picture, Privacy Mask, Tampering Alarm, Text Overlay, Digital PTZ
<b>Language</b>	Arabic / Bulgarian / Czech / Danish / Dutch / English / Finnish / French / German / Greek / Hebrew / Hungarian / Indonesian / Italian /Japanese / Lithuanian / Norwegian / Persian / Polish / Portuguese / Romanian / Russian / Serbian / Simplified Chinese / Slovakian / Slovenian / Spanish / Swedish / Thai / Traditional Chinese / Turkish

## Application

<b>Network Storage</b>	GV-NVR, GV-System, GV-Backup Center, GV-Recording Server
<b>Smart Device Access</b>	GV-Eye for Android smartphone, tablet, iPhone, and iPod Touch; GV-Eye HD for iPad
<b>Live Viewing</b>	IE, mobile phone
<b>CMS Server support</b>	GV-Control Center, GV-Center V2, GV-VSM
<b>Note:</b> GV-Backup Center, GV-Video Gateway and GV-Recording Server are only supported for V1.03 or later.	

All specifications are subject to change without prior notice.

# Specifications: Advanced Cube

## Camera

### Camera

<b>Image Sensor</b>		1/2.5" progressive scan CMOS
<b>Picture Elements</b>	<b>GV-CA120 GV-CAW120</b>	1280 (H) x 1024 (V)
	<b>GV-CA220 GV-CAW220</b>	1920 (H) x 1080 (V)
<b>Minimum Illumination</b>	<b>Color</b>	0.15 Lux
	<b>B/W</b>	0.10 Lux
	<b>LED on</b>	0 Lux
<b>Shutter Speed</b>		Automatic, Manual (1/5 ~ 1/8000 sec)
<b>White Balance</b>		Automatic, Manual (2800 ~ 8500K)
<b>Gain Control</b>		Automatic
<b>S/N Ratio</b>		45 db
<b>WDR</b>		Yes

### Lens

<b>Megapixel</b>	Yes
<b>Day/Night</b>	Yes (electronic)
<b>Lens Type</b>	Fixed
<b>Focal Length</b>	3.35 mm
<b>Maximum Aperture</b>	F/2.4
<b>Mount</b>	M12 mm

<b>Image Format</b>		1/3"
<b>Horizontal FOV</b>	<b>GV-CA120</b> <b>GV-CAW120</b>	67°
	<b>GV-CA220</b> <b>GV-CAW220</b>	77°
<b>Operation (Focus / Zoom / Iris)</b>		Fixed

## Operation

<b>Video Compression</b>		H.264, MJPEG
<b>Video Stream</b>		Dual streams from H.264 or MJPEG
<b>Frame Rate</b>	<b>GV-CA120</b> <b>GV-CAW120</b>	30 fps at 1280 x 1024
	<b>GV-CA220</b> <b>GV-CAW220</b>	30 fps at 1920 x 1080
<b>Image Setting</b>		Brightness, Contrast, Saturation, Sharpness, Gamma, White Balance, Flicker-less, Image Orientation, Shutter Speed, Backlight Compensation, WDR, Defog
<b>Audio Compression</b>		G.711, AAC (Optional)
<b>Audio Support</b>		Two-Way Audio
<b>Note:</b> The frame rate and performance may vary depending on the number of connections and data bitrates (different scenes).		

## Specifications: Advanced Cube Camera

### Video Resolution

GV-CA120 GV-CAW120	Main Stream	4:3	1280 x 960, 640 x 480, 320 x 240
		16:9	1280 x 720, 640 x 360, 448 x 252
		5:4	1280 x 1024, 640 x 512, 320 x 256
	Sub Stream	4:3	640 x 480, 320 x 240
		16:9	640 x 360, 448 x 252
		5:4	640 x 512, 320 x 256
GV-CA220 GV-CAW220	Main Stream	4:3	1600 x 1200, 1280 x 960, 640 x 480, 320 x 240
		16:9	1920 x 1080, 1280 x 720, 640 x 360, 448 x 252
		5:4	1280 x 1024, 640 x 512, 320 x 256
	Sub Stream	4:3	640 x 480, 320 x 240
		16:9	640 x 360, 448 x 252
		5:4	640 x 512, 320 x 256

### Network

Interface	10/100 Ethernet
Protocol	DHCP, DynDNS, FTP, HTTP, HTTPS, NTP, ONVIF (Profile S), PSIA, QoS (DSCP), RTSP, SNMP, SMTP, TCP, UDP, UPnP, 3GPP/ISMA

### Network (for GV-CAW120 / 220 only)

Wireless LAN	IEEE 802.11 b/g/n
Antenna Type	Built-in
Security	WEP, WPA-PSK(TKIP), WPA-PSK(AES), WPA2-PSK(TKIP), WPA2-PSK(AES)
<b>Note:</b> The signal range and data throughput may vary depending on the network conditions and environmental factors.	

## Mechanical

<b>Temperature Detector</b>		No
<b>Connectors</b>	<b>Power</b>	DC Jack / PoE (only for CA120/CA220)
	<b>Ethernet</b>	Ethernet (10/100 Base-T), RJ-45 cable
	<b>Audio</b>	Built-in speaker & microphone
	<b>Local Storage</b>	Micro SD card slot (SD/SDHC, version 2.0 only, Class 10)
<b>LED Indicator</b>		4 LEDs: Status x 3, LAN / Wi-Fi
<b>PIR Sensor</b>		Built-in
<b>White Illumination LED</b>		Yes
<b>Max. PIR / White Illumination LED Distance</b>		5 m (16.4 ft)
<b>Note:</b> SDXC and UHS-I card types are not supported.		

## General

<b>Environment Temperature</b>		0°C ~ 50°C (32°F ~ 122°F)
<b>Humidity</b>		10% to 90% (no condensation)
<b>Power Source</b>	<b>GV-CA120 GV-CA220</b>	5V DC, PoE
	<b>GV-CAW120 GV-CAW220</b>	5V DC
<b>Max. Power Consumption</b>	<b>GV-CA120 GV-CA220</b>	7 W
	<b>GV-CAW120 GV-CAW220</b>	6 W
<b>Dimensions (L X W X H)</b>		65.8 x 99.8 x 39 mm (2.59" x 3.92" x 1.54")
<b>Weight</b>		100 g (0.2 lb)
<b>Regulatory</b>		CE, FCC, C-Tick, RoHS compliant

## Specifications: Advanced Cube Camera

### Power over Ethernet

<b>PoE Standard</b>	IEEE 802.3af Class 3 Power over Ethernet / PD
<b>PoE Power Supply Type</b>	End-Span
<b>PoE Power Output</b>	Per Port 48V DC, 350mA. Max. 15.4 watts

### Web Interface

<b>Installation Management</b>	Web-based configuration
<b>Maintenance</b>	Firmware upgrade through Web Browser or Utility
<b>Access from Web Browser</b>	Camera live view, video recording, change video quality, bandwidth control, image snapshot, audio, Picture in Picture, Picture and Picture, Privacy Mask, Tampering Alarm, Text Overlay, Digital PTZ
<b>Language</b>	Arabic / Bulgarian / Czech / Danish / Dutch / English / Finnish / French / German / Greek / Hebrew / Hungarian / Indonesian / Italian / Japanese / Lithuanian / Norwegian / Persian / Polish / Portuguese / Romanian / Russian / Serbian / Simplified Chinese / Slovakian / Slovenian / Spanish / Swedish / Thai / Traditional Chinese / Turkish

### Application

<b>Network Storage</b>	GV-NVR, GV-System, GV-Backup Center, GV-Recording Server
<b>Smart Device Access</b>	GV-Eye for Android smartphone, tablet, iPhone, and iPod Touch; GV-Eye HD for iPad
<b>Live Viewing</b>	IE, mobile phone
<b>CMS Server Support</b>	GV-Control Center, GV-Center V2,



	GV-VSM
--	--------

All specifications are subject to change without prior notice

## Specifications: Advanced Cube Camera

### Application

<b>Network Storage</b>	GV-NVR, GV-System, GV-Backup Center, GV-Recording Server
<b>Smart Device Access</b>	GV-Eye for Android smartphone, tablet, iPhone, and iPod Touch; GV-Eye HD for iPad
<b>Live Viewing</b>	IE, mobile phone
<b>CMS Server Support</b>	GV-Control Center, GV-Center V2, GV-VSM

All specifications are subject to change without prior notice