

# **Bronze Class IntelliPix DVR User Manual**

# Table of Contents

<b>1</b>	<b>FEATURES AND SPECIFICATIONS.....</b>	<b>10</b>
1.1	Overview .....	10
1.2	Features .....	10
1.3	Specification .....	11
<b>2</b>	<b>OVERVIEW AND CONTROLS .....</b>	<b>15</b>
2.1	Front Panel .....	15
2.2	Rear Panel.....	16
2.3	Connection Sample .....	17
2.4	Remote Control.....	18
2.5	Mouse Control.....	19
2.6	Virtual Keyboard & Front Panel .....	20
2.6.1	Virtual Keyboard.....	20
2.6.2	Front Panel .....	20
<b>3</b>	<b>INSTALLATION AND CONNECTIONS.....</b>	<b>21</b>
3.1	Check Unpacked DVR.....	21
3.2	About Front Panel and Real Panel .....	21
3.3	HDD Installation .....	21

<b>3.4</b>	<b>Connecting Power Supply</b> .....	<b>22</b>
<b>3.5</b>	<b>Connecting Video Input and Output Devices</b> .....	<b>22</b>
3.5.1	Connecting Video Input.....	22
3.5.2	Connecting Video Output.....	23
<b>3.6</b>	<b>Connecting Audio Input &amp; Output, Bidirectional Audio</b> .....	<b>23</b>
3.6.1	Audio Input.....	23
3.6.2	Audio Output.....	24
<b>3.7</b>	<b>Alarm Input and Output Connection</b> .....	<b>24</b>
3.7.1	Alarm Input and Output Details.....	25
3.7.2	Alarm Input Port .....	26
3.7.3	Alarm Output Port .....	26
<b>3.8</b>	<b>RS232</b> .....	<b>27</b>
<b>3.9</b>	<b>RS485</b> .....	<b>27</b>
<b>3.10</b>	<b>Other Interfaces</b> .....	<b>28</b>
<b>4</b>	<b>OVERVIEW OF NAVIGATION AND CONTROLS</b> .....	<b>29</b>
<b>4.1</b>	<b>Login, Logout &amp; Main Menu</b> .....	<b>29</b>
4.1.1	Login .....	29
4.1.2	Main Menu .....	29
4.1.3	Logout.....	30
4.1.4	Auto Resume after Power Failure .....	30
4.1.5	Replace Button Battery .....	30
<b>4.2</b>	<b>Manual Record</b> .....	<b>30</b>
4.2.1	Live Viewing.....	30
4.2.2	Manual record.....	30
<b>4.3</b>	<b>Search &amp; Playback</b> .....	<b>32</b>
4.3.1	Search Menu .....	32
4.3.2	Basic Operation.....	33

4.3.3	Calendar.....	34
<b>4.4</b>	<b>Schedule .....</b>	<b>35</b>
4.4.1	Schedule Menu .....	35
4.4.2	Snapshot .....	36
4.4.3	Image FTP .....	37
<b>4.5</b>	<b>Detect.....</b>	<b>37</b>
4.5.1	Go to Detect Menu.....	37
4.5.2	Motion Detect.....	38
4.5.3	Video Loss.....	40
4.5.4	Camera Masking.....	40
<b>4.6</b>	<b>Alarm Setup and Alarm Activation .....</b>	<b>41</b>
4.6.1	Go to alarm setup interface.....	41
4.6.2	Alarm setup.....	41
<b>4.7</b>	<b>Backup .....</b>	<b>43</b>
4.7.1	Detect Device.....	43
4.7.1	Backup.....	44
<b>4.8</b>	<b>PTZ Control and Color Setup .....</b>	<b>45</b>
4.8.1	Cable Connection .....	45
4.8.2	PTZ Setup .....	45
4.8.3	3D Intelligent Positioning Key.....	47
<b>4.9</b>	<b>Preset/ Patrol/Pattern/Scan.....</b>	<b>47</b>
4.9.1	Preset Setup .....	48
4.9.2	Activate Preset.....	48
4.9.3	Patrol setup (Tour Setup).....	48
4.9.4	Activate Patrol (tour).....	49
4.9.5	Pattern Setup .....	49
4.9.6	Activate Pattern Function.....	49
4.9.7	Auto Scan Setup .....	49
4.9.8	Activate Auto Scan.....	50
<b>4.10</b>	<b>Flip .....</b>	<b>50</b>
<b>5</b>	<b>UNDERSTANDING OF MENU OPERATIONS AND CONTROLS .....</b>	<b>51</b>



<b>5.1</b>	<b>Menu Tree .....</b>	<b>51</b>
<b>5.2</b>	<b>Main Menu .....</b>	<b>51</b>
<b>5.3</b>	<b>Setting .....</b>	<b>52</b>
5.3.1	General .....	52
5.3.2	Encode .....	53
5.3.3	Schedule .....	54
5.3.4	RS232 .....	54
5.3.5	Network .....	55
5.3.6	Alarm.....	62
5.3.7	Detect .....	62
5.3.8	Pan/Tilt/Zoom .....	62
5.3.9	Display .....	62
5.3.10	Default.....	64
<b>5.4</b>	<b>Search.....</b>	<b>65</b>
<b>5.5</b>	<b>Advanced.....</b>	<b>65</b>
5.5.1	HDD Management.....	65
5.5.2	Abnormity.....	66
5.5.3	Alarm Output.....	67
5.5.4	Manual Record.....	67
5.5.5	Account.....	67
5.5.6	Auto Maintain.....	68
5.5.7	TV Adjust.....	68
<b>5.6</b>	<b>Information.....</b>	<b>69</b>
5.6.1	HDD Information .....	69
5.6.2	BPS .....	70
5.6.3	Log .....	70
5.6.4	Version .....	71
5.6.5	Online Users.....	71
<b>5.7</b>	<b>Shutdown.....</b>	<b>72</b>
<b>6</b>	<b>ABOUT AUXILIARY MENU .....</b>	<b>73</b>
<b>6.1</b>	<b>Go to Pan/Tilt/Zoom Menu .....</b>	<b>73</b>

6.1.1	3D Intelligent Positioning Key .....	73
<b>6.2</b>	<b>Preset /Patrol / Pattern /Border Function.....</b>	<b>74</b>
6.2.1	Preset Setup .....	75
6.2.2	Activate Preset .....	75
6.2.3	Patrol Setup .....	75
6.2.4	Activate Patrol .....	75
6.2.5	Pattern Setup.....	75
6.2.6	Activate Pattern Function.....	76
6.2.7	Border Setup.....	76
6.2.8	Activate Border Function .....	76
6.2.9	Flip .....	76
<b>7</b>	<b>WEB CLIENT OPERATION.....</b>	<b>78</b>
<b>7.1</b>	<b>Network Connection.....</b>	<b>78</b>
<b>7.2</b>	<b>Login.....</b>	<b>78</b>
7.2.1	Real-time Monitor.....	80
7.2.2	PTZ .....	82
7.2.3	Color .....	85
7.2.4	Picture Path and Record Path .....	85
<b>7.3</b>	<b>Configure .....</b>	<b>86</b>
7.3.1	System Information.....	86
7.3.2	System Configuration .....	88
7.3.3	Advanced .....	105
7.3.4	Additional Function .....	111
<b>7.4</b>	<b>Search.....</b>	<b>111</b>
<b>7.5</b>	<b>Alarm .....</b>	<b>115</b>
<b>7.6</b>	<b>About .....</b>	<b>116</b>
<b>7.7</b>	<b>Log out .....</b>	<b>116</b>
<b>7.8</b>	<b>Un-install Web Control.....</b>	<b>116</b>

8	PROFESSIONAL SURVEILLANCE SYSTEM .....	117
9	FAQ.....	118
	APPENDIX A HDD CAPACITY CALCULATION .....	123
	APPENDIX B COMPATIBLE USB DRIVE LIST .....	124
	APPENDIX C COMPATIBLE CD/DVD BURNER LIST .....	125
	APPENDIX D COMPATIBLE SATA HDD LIST .....	126

## **Welcome**

Thank you for purchasing our DVR!

This operating manual is designed to be a reference tool for the installation and operation of your system.

Here you can find information about the Bronze Class IntelliPix features and functions, as well as a detailed menu tree.

Before installation and operation please read the following safeguards and warnings carefully!

# Important Safeguards and Warnings

## 1 . Electrical safety

All installation and operation here should conform to your local electrical safety codes. We assume no liability or responsibility for all the fires or electrical shock caused by improper handling or installation.

## 2 . Transportation security

Heavy stress, violent vibration or water splash are not allowed during transportation, storage and installation.

## 3 . Installation

Keep upwards. Handle with care.

Do not apply power to the DVR before completing installation.

Do not place objects on the DVR

## 4 . Qualified engineers needed

All the examination and repair work should be done by the qualified service engineers.

We are not liable for any problems caused by unauthorized modifications or attempted repair.

## 5 . Environment

The DVR should be installed in a cool, dry place away from direct sunlight, inflammable, explosive substances and etc.

## 6. Accessories

Be sure to use all the accessories recommended by manufacturer.

Before installation, please open the package and check all the components are included.

Contact your local retailer ASAP if something is broken in your package.

# 1 FEATURES AND SPECIFICATIONS

## 1.1 Overview

The Bronze Class IntelliPix is an excellent digital monitor product. It adopts embedded Linux OS to maintain reliable operation. Popular H.264 compression algorithm and G.711 audio compression technology realize high quality, low bit stream. Unique frame by frame play function is suitable for detail analysis. It has various functions such as record, playback, monitor at the same time and can guarantee audio video synchronization. The Bronze Class IntelliPix has advanced technology and strong network data transmission function.

The Bronze Class IntelliPix adopts embedded design to achieve high security and reliability. It can work in the local end, and at the same time, when connecting it to the professional surveillance software (PSS), it can connect to security network to realize strong network and remote monitor function. The Bronze Class IntelliPix can be widely used in various areas such as banking, telecommunication, electric power, interrogation, transportation, intelligent resident zone, factory, warehouse, resources, and water conservancy.

## 1.2 Features

The Bronze Class IntelliPix has the following features:

- **Real-time monitor**

It has analog output port and VGA output port. You can use monitor or displayer to realize surveillance function.

System supports TV and VGA output at the same time, and reserve HDMI port for future development.

- **Storage function**

Special data format to guarantee data security and can avoid vicious data modification.

- **Compression format**

Support multiple-channel audio and video. An independent hardware decodes the audio and video signal from each channel to maintain video and audio synchronization.

- **Backup function**

Via USB port (such as flash disk and portable HDD)

Client-end user can download the file to local HDD to backup via network.

- **Record playback function**

Support each channel real-time record, and at the same time can support search, forward play, network monitor, record search, download and etc.

Support various playback modes: slow play, fast play, backward play and frame by frame play.

Support time title overlay so that you can view event accurate occurred time

Support specified zone enlargement.

- **Network operation**

Support network remote real-time monitor, remote record search and remote PTZ control.

- **Alarm activation function**

Several relay alarm outputs to realize alarm activation and on-site light control.

- **Communication port**

RS485 port can realize alarm input and PTZ control.

RS232 port can connect to keyboard to realize central control, and can also connect to PC COM to upgrade system and realize maintenance, and matrix control.

Standard Ethernet port can realize network access function.

- **PTZ control**

Support PTZ decoder via RS485.

Support various decode protocols to allow the PTZ to control the speed dome.

- **Intelligent operation**

Mouse operation function

In the menu, support copy and paste setup function

**Slight function differences may be found due to different classes.**

### 1.3 Specification

	Parameter	4-ch	8-ch	16-ch
System	Main Processor	High-performance industrial embedded micro controller		
	OS	Embedded LINUX		
	System Resources	Multiplex operations: Multiple-channel record, multiple-channel playback and network operation simultaneously		
	Interface	User-friendly graphical user interface		
	Input Devices	Front panel, USB mouse, remote control		
	Input Method	Arabic number, English character, donation and extension Chinese (optional)		
	Shortcut Function	Copy/paste operation, USB mouse right-key shortcut menu, double click USB mouse to switch screen.		
Compression Standard	Video Compression	H.264		
	Audio Compression	G.711A		
Video monitor	Video Input	4-CH composite video input: (NTSC/PAL) BNC (1.0V <sub>P-P</sub> , 75Ω)	8-CH composite video input: (NTSC/PAL) BNC (1.0V <sub>P-P</sub> , 75Ω)	16-CH composite video input: (NTSC/PAL) BNC (1.0V <sub>P-P</sub> , 75Ω)
	Video Output	1-ch PAL/NTSC BNC (1.0VP- P, 75Ω) composite video signal output. 1-ch VGA output; 1-ch HDMI output (Reserved port) Support TV/VGA/HDMI video output at the same time.		
	Video Standard	PAL (625 line, 50f/s), NTSC (525 line, 60f/s)		
	Record Speed	Real-time Mode: PAL 1f/s to 25f/s per channel and NTSC 1f/s to 30f/s per channel		

	Video Partition	1/4 windows(Optional)	1/4/9 windows	1/4/9 /16 windows
	Monitor Touring	Support monitor tour functions such as alarm, motion detection, and schedule auto control.		
	Resolution (PAL/NTSC )	PAL/NTSC Real-time monitor: D1 704×576/704×480 Playback: 1/9-ch: D1 704×576/704×480 , CIF 352×288/ 352×240 , QCIF 176×144/176×120 Other channels CIF 352×288/ 352×240 、 QCIF 176×144/176×120 Support dual streams: extra stream resolution QCIF 176×144/176×120		
	Motion Detection	Zone setup: support max 396(22×18) zones. Support various sensitivities.		
	Image Quality	6-level image quality (Adjustable)		
	Privacy mask	Support one privacy mask of user-defined size in full screen. Support max 4 zones.		
	Image Information	Channel information, time information and privacy mask zone.		
	TV Adjust	Adjust TV output zone suitable to anamorphic video;		
	Channel Lock	Cover secret channel with blue screen though system is encoding normally. Screen -lock function to prevent unauthorized user seeing secret video.		
	Channel Information	Channel name, recording status, screen lock status, video loss status and motion detection status are shown on the bottom left of display screen.		
	Color Configuration	Hue, brightness, contrast, saturation and gain setup for each channel.		
Audio	Audio Input	4-ch 200-2000mv10KΩ(BNC)	8-ch 200-2000mv10KΩ(BNC)	4-ch 200-2000mv10KΩ (BNC)
	Audio Output	1-ch audio output 200-3000mv 5KΩ(BNC)		
	Bidirectional Audio	Current series products <b>do not</b> support audio talk function.		
Hard disk	Hard Disk	1 built-in SATA port. Support 1 HDD.		
	Hard Disk Occupation	Audio: PCM 28.8MByte/h Video: 56-900MByte/h		
Record and playback	Recording Mode	Manual recording, motion detection recording, schedule recording and alarm recording Priority: Manual recording> alarm recording>motion detection recording>schedule recording.		
	Recording Length	1 to 120 minutes single record duration (Default 60 minutes)		
	Playback Repeat Way	When hard disk is full, system can overwrite previous video file.		
	Record Search	Various search engines such as time, type and channel.		
	Playback Mode	Various fast play, slow play speeds, manual frame by frame playback and reverse play mode.		



	Various File Switch Ways	Can switch to previous or next file or any file in current play list. Can switch to file on other channel of the same time. (If there is a file) Support file continuous play, when file is end system auto plays the next file in the current channel
	Multi-channel Playback	Support one to two channel(s)   playback(s) at the same time. Max supports 4-channel playback.
	Window Zoom	Switch between adaptive screen/full screen when playback
	Partial Enlargement	When in one-window full-screen playback mode, you can select any zone to activate partial enlargement function.
Backup function	Backup Mode	HDD backup
		Support peripheral USB backup device. (Flash disk, portable disk and etc.)
		Support USB burner (extension function).
		Support network download and backup
Network Function	Network control	View monitor channel remotely.
		DVR configuration through client-end and web browser
		Upgrade via client or browser to realize remote maintenance.
		View alarm information such as external alarm, motion detection and video loss via client.
		Support network PTZ control
		File download backup and playback
		Multiple devices share information via corresponding software such as professional surveillance software (PSS)
		Duplex transparent COM
		Network alarm input and output
		Bidirectional audio (These series products <b>do not</b> support)
Motion Detection and Alarm	Motion Detection	Zone setup: support 396(22×18) detection zones. Various sensitivity levels. Alarm can activate record or external alarm or screen message prompt.
	Video Loss	Alarm can activate external alarm or screen message prompt.
	External Alarm	Support record activation function or activate external alarm or screen message in specified period.
	Manual Alarm Control	Enable or disable alarm input channel Support analog alarm signal to specific alarm output channel.
	Alarm Input	4-ch alarm input (Normal open or normal close)
	Alarm Output	3-channel relay output (Including one controllable +12V)
	Alarm Relay	30VDC 2A, 125VAC 1A (activation alarm)
Interface	USB Interface	2 USB 2.0 ports.
	Network connection	RJ45 10M/100M self-adaptable Ethernet port
	RS485	PTZ control port Support various PTZ control protocols.
	RS232	Ordinary serial port(Debug),keyboard connection and transparent serial port(COM input and output via network)
System Information	Hard Disk Information	Display HDD current status
	Data Stream Statistics	Data stream statistics for each channel (in wave mode)
	Log statistics	Backup to 1024 log files. Support various search engines such as time and type.

	Version	Display version information: channel amount, alarm input and output amount, system version and published date.
	On-line user	Display current on-line user
User Management	User Management	Multi-lever user management; various management modes Integrated management for local user, serial port user and network user. Configurable user power.
		Support user /group and its corresponding rights modification. No limit to the user or group amount.
	Password Authentication	Password modification Administrator can modify other user's password. Account lock strategy Five times login failure in thirty minutes may result in account lock.
Upgrade		Web browser, client-end and specific update tool.
Login, Logout and Shutdown		Password login protection to guarantee safety
		User-friendly interface when login. Provide the following options: Logout /shutdown/ restart.
		Right authentication when shut down to make sure only those proper people can turn off DVR
General Parameter	Power	DC +12V/3.3A
	Power Consumption	12W (Exclude HDD)
	Working Temperature	0°C – +55°C
	Working Humidity	10% – 90%
	Air Pressure	86kpa – 106kpa
	Dimension	375 x285 x45mm
	Weight	3.25KG(Exclude HDD)
	Installation Mode	Desktop installation

## 2 Overview and Controls

This section provides information about front panel and rear panel. When you install the Bronze Class IntelliPix DVR for the first time, please refer to this part first.

### 2.1 Front Panel

The front panel is shown as in Figure 2-1.

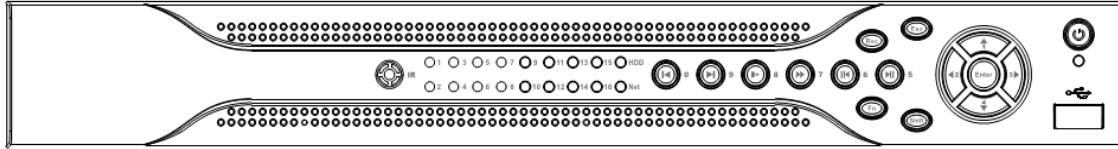



Figure 2-1

Please refer to the following sheet for front panel button information.

Name	Icon	Function
Power button		Power button, press this button for three seconds to boot up or shut down DVR.
Shift	Shift	In textbox, click this button to switch between numeral, English(Small/Capitalized),donation and etc.
Up/1 Down/4		Activate current control, modify setup, and then move up and down.
		Increase/decrease numeral.
		Assistant function such as PTZ menu.
		In text mode, input number 1/4.
Left/2 Right/3		Shift current activated control,
		When playback, click these buttons to control playback bar. In text mode, input number 2/3.
ESC	ESC	Go to previous menu, or cancel current operation.
		When playback, click it to restore real-time monitor mode.
Enter	ENTER	Confirm current operation
		Go to default button
		Go to menu
Record	REC	Manually stop/start recording, working with direction keys or numeral keys to select the recording channel.
Slow play/8		Multiple slow play speeds or normal playback. In text mode, input number 8.

Assistant	Fn	One-window monitor mode, click this button to display assistant function: PTZ control and image color. In PTZ menu, shift PTZ control menu.
		Backspace function: in numeral control or text control, it can delete the previous character before the cursor.
		In motion detection setup, working with Fn and direction keys to realize setup.
		In preview mode, click it for three seconds to switch between TV.VGA. For HD1 series DVR, there are three modes: TV, VGA, VGA_LCD (60Hz LED output).
		In text mode, click it to switch between numeral, English character(small/capitalized) and etc.
		Realize other special functions.
Fast play/7	▶▶	Various fast speeds and normal playback. In text mode, input number 7.
Play previous/0	◀	In playback mode, playback the previous video In text mode, input number 0.
Reverse/Pause/6	◀	In normal playback or pause mode, click this button to reverse playback In reverse playback, click this button to pause playback. In text mode, input number 6.
Play Next/9	▶	In playback mode, playback the next video In menu setup, go to down ward of the dropdown list. In text mode, input number 9.
Play/Pause /5	▶	In normal playback click this button to pause playback In pause mode, click this button to resume playback. In text mode, input number 5.
USB port		To connect USB storage device, USB mouse.
Network abnormal indication light	Net	Network error occurs or there is no network connection, the light becomes red to alert you.
HDD abnormal indication light	HDD	HDD error occurs or HDD capacity is below specified threshold value, the light becomes red to alert you.
Record light	Alarm	System is recording or not. It becomes on when system is recording.
IR Receiver	IR	It is to receive the signal from the remote control (not included in the accessory bag).

## 2.2 Rear Panel

The 4-ch rear panel is shown as below. See Figure 2-2.

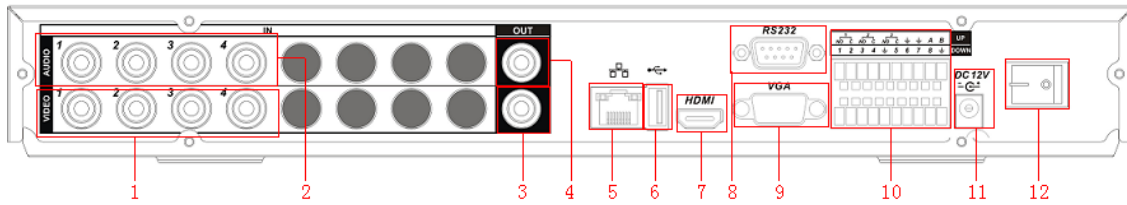

Figure 2-2

The 8-ch rear panel is shown as below. See Figure 2-3.

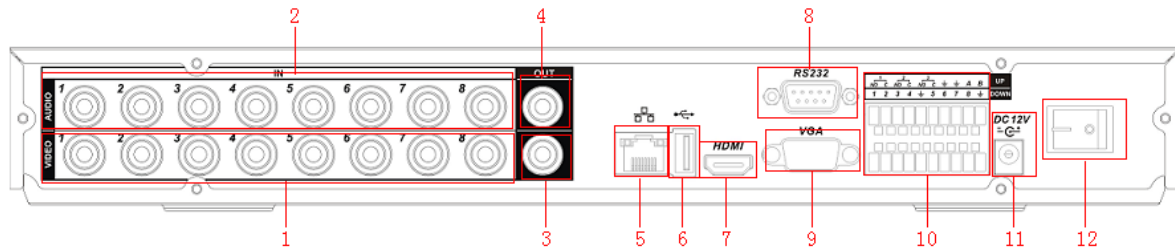

Figure 2-3

The 16-ch rear panel is shown as below. See Figure 2-4.

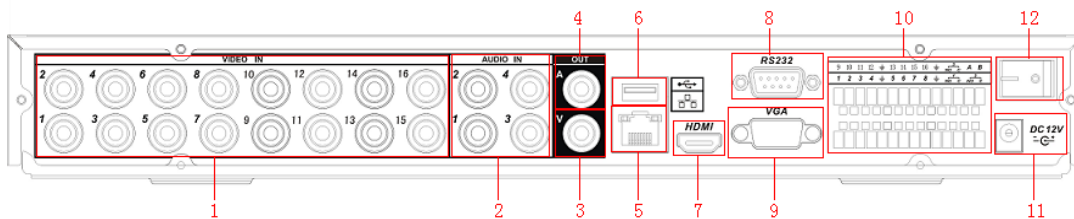

Figure 2-4

Please refer to the following sheet for detail information.

1	Video input
2	Audio input
3	Video CVBS output
4	Audio output
5	Network port
6	USB port
7	HDMI port
8	RS232 port
9	Video VGA output
10	Alarm input/alarm output/RS485 port
11	Power input port
12	Power button

When connect the Ethernet port, please use straight cable to connect the PC and use the crossover cable to connect to the switcher or router.

## 2.3 Connection Sample

Please refer to Figure 2-5 for connection sample.

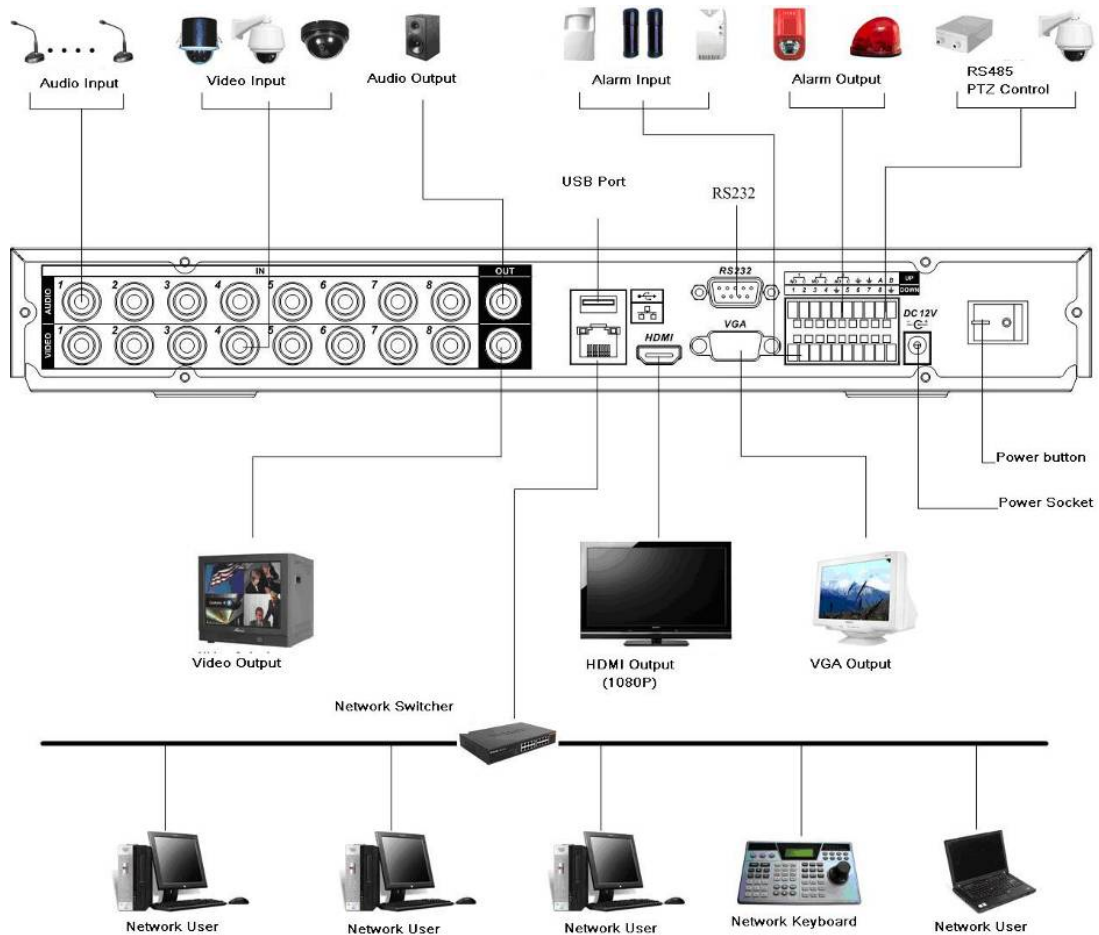

Figure 2-5

## 2.4 Remote Control

The remote control interface is shown as in Figure 2-6.

Please note remote control is not our standard accessory and it is not included in the accessory bag.

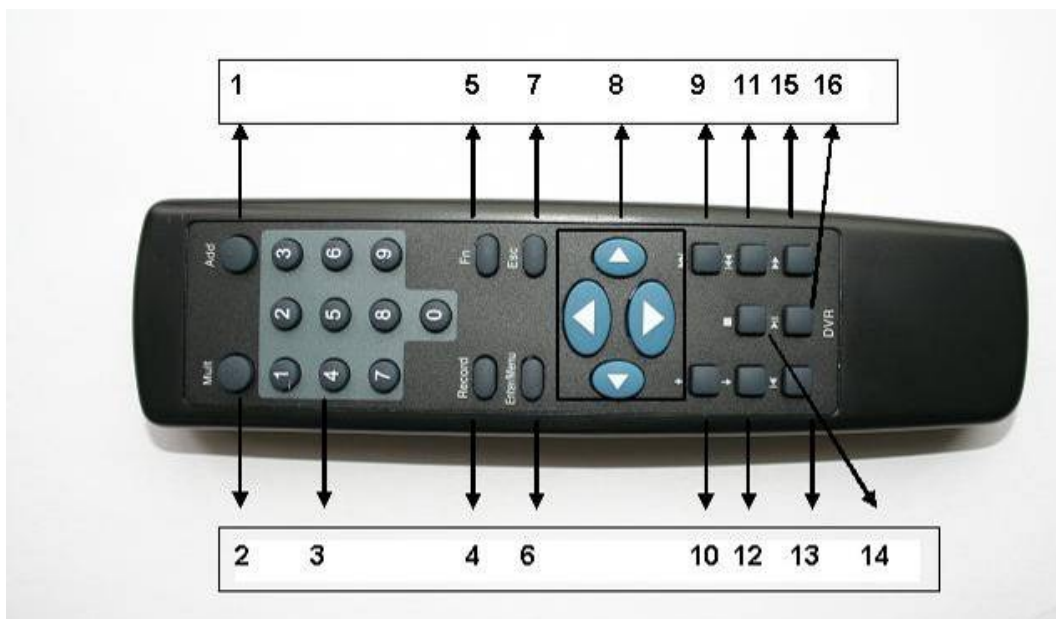





Figure 2-6

Serial Number	Function
1	remote switch
2	Multiple-window switch
3	0-9 number key
4	Record
5	Auxiliary key
6	Confirm /menu key
7	Cancel
8	Direction key
9	forward
10	Previous
11	Back
12	Next
13	Slow play
14	Stop
15	Fast play
16	Play/Pause

## 2.5 Mouse Control

<p>Left click mouse</p>	<p>System pops up password input dialogue box if you have not logged in. In real-time monitor mode, you can go to the main menu.</p> <p>When you have selected one menu item, left click mouse to view menu content.</p> <p>Implement the control operation.</p> <p>Modify checkbox or motion detection status.</p> <p>Click combo box to pop up drop down list</p> <p>In input box, you can select input methods. Left click the corresponding button on the panel you can input numeral/English character (small/capitalized). Here ← stands for backspace button. _ stands for space button.</p> <p>In English input mode: _stands for input a backspace icon and ← stands for deleting the previous character.</p> <div style="display: flex; justify-content: space-around; align-items: center;">   </div> <p>In numeral input mode: _ stands for clear and ← stands for deleting the previous numeral.</p> <p>When input special sign, you can click corresponding numeral in the front panel to input. For example, click numeral 1 you can input“/”, or you can click the numeral in the on-screen keyboard directly.</p> 
<p>Double left click mouse</p>	<p>Implement special control operation such as double click one item in the file list to playback the video.</p>

	In multiple-window mode, double left click one channel to view in full-window. Double left click current video again to go back to previous multiple-window mode.
Right click mouse	In real-time monitor mode, pops up shortcut menu: one-window, four-window, nine-window and sixteen-window, Pan/Tilt/Zoom, color setting, search, record, alarm input, alarm output, main menu. Among which, Pan/Tilt/Zoom and color setting applies for current selected channel. If you are in multiple-window mode, system automatically switches to the corresponding channel. 
	Exit current menu without saving the modification.
Press middle button	In numeral input box: Increase or decrease numeral value. Switch the items in the check box. Page up or page down
Move mouse	Select current control or move control
Drag mouse	Select motion detection zone Select privacy mask zone.

## 2.6 Virtual Keyboard & Front Panel

### 2.6.1 Virtual Keyboard

The system supports two input methods: numeral input and English character (small and capitalized) input.

Move the cursor to the text column, the text is shown as blue, input button pops up on the right. Click that button to switch between numeral input and English input (capitalized and small), Use > or < to shift between small character and capitalized character.

### 2.6.2 Front Panel

Move the cursor to the text column. Click Fn key and use direction keys to select number you wanted. Please click enter button to input.



### 3 Installation and Connections

**Note:** All the installation and operations here should conform to your local electric safety rules.

#### 3.1 Check Unpacked DVR

When you receive the DVR from the forwarding agent, please check whether there is any visible damage. The protective materials used for the package of the DVR can protect most accidental clashes during transportation. Then you can open the box to check the accessories.

Please check the items in accordance with the list on the warranty card (Remote control is optional). Finally you can remove the protective film of the DVR.

**Note**

Remote control is not a standard accessory and it is not included in the accessory bag.

#### 3.2 About Front Panel and Real Panel

For detail information of the function keys in the front panel and the ports in the rear panel, please refer to the *User's Manual* included in the resource CD.

The model in the front panel is very important; please check according to your purchase order. The label in the rear panel is very important too. Usually we need you to represent the serial number when we provide the service after sales.

#### 3.3 HDD Installation

The Bronze Class IntelliPix DVR has only one SATA HDD. Please use HDD of 7200rpm or higher. You can refer to the *User's Manual* for recommended HDD brand.

Please follow the instructions below to install hard disk.



1. Loosen the screws of the upper cover.



2. Remove upper cover.



3. Turn four screws for three rounds to fix HDD bracket.



4. Place the HDD in accordance with the four holes.



5. Turn the device upside down and then turn the screw in firmly.



6. Fix the HDD firmly.



7. Connect the HDD cable and power cable.



8. Place the upper cover back and screw firmly.

After completing HDD installation, please check connection of data ribbon and power cord.

### 3.4 Connecting Power Supply

Please check input voltage and device power button match or not.

We recommend you use UPS to guarantee steady operation, DVR life span, and other peripheral equipments operation such as cameras.

### 3.5 Connecting Video Input and Output Devices

#### 3.5.1 Connecting Video Input

The video input interface is BNC. The input video format includes: PAL/NTSC BNC (1.0V<sub>P-P</sub>, 75Ω. See Figure 3-1.

The video signal should comply with your national standards.

The input video signal shall have high SNR, low distortion; low interference, natural color and suitable lightness.

#### **Guarantee the stability and reliability of the camera signal:**

The camera shall be installed in a cool, dry place away from direct sunlight, inflammable, explosive substances and etc.

The camera and the DVR should have the same grounding to ensure the normal operation of the camera.

#### **Guarantee stability and reliability of the transmission line**

Please use high quality, sound shielded BNC. Please select suitable BNC model according to the transmission distance.

If the distance is too long, you should use twisted pair cable, and you can add video compensation devices or use optical fiber to ensure video quality.

You should keep the video signal away from the strong electromagnetic interference, especially the high tension current.

#### **Keep connection lugs in well contact**

The signal line and shielded wire should be fixed firmly and in well connection. Avoid dry joint, lap welding and oxidation.

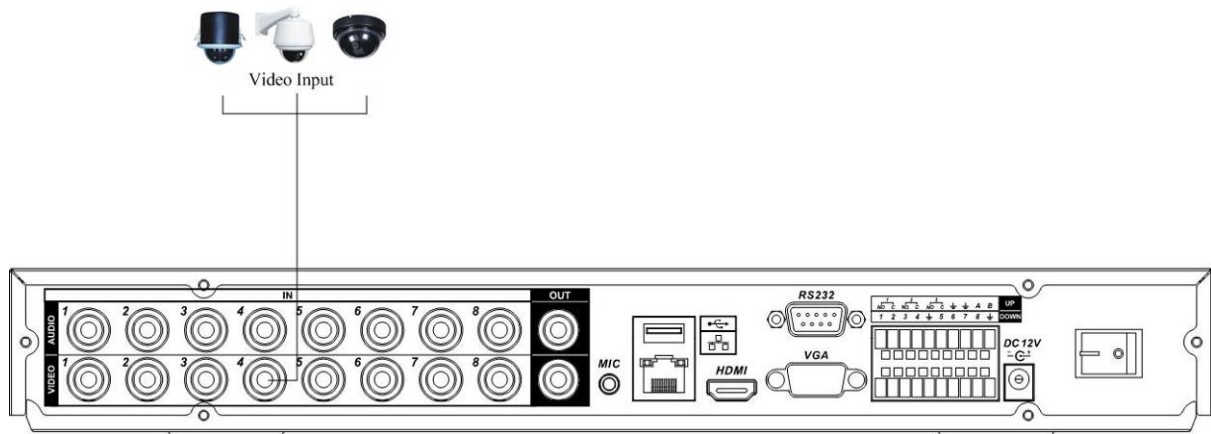

Figure 3-1

### 3.5.2 Connecting Video Output

Video output includes a BNC(PAL/NTSC BNC (1.0VP- P, 75Ω ) output and a VGA output. System supports BNC and VGA output at the same time. System also reserves a HDMI port. See Figure 3-2.

When you are using pc-type monitor to replace the monitor, please pay attention to the following points:

- To defer aging, do not allow the pc monitor to run for a long time.
- Regular demagnetization will keep device maintain proper status.
- Keep away it away from strong electromagnetic interference devices.

Using TV as video output device is not a reliable substitution method. You also need to reduce the working hour and control the interference from power supply and other devices. The low quality TV may result in device damage.

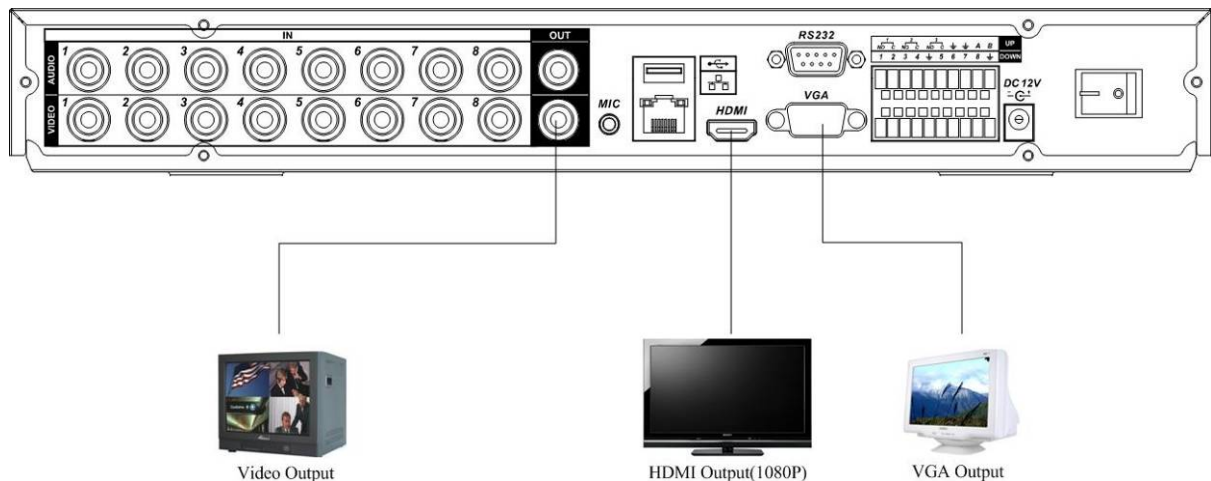

Figure 3-2

## 3.6 Connecting Audio Input & Output, Bidirectional Audio

### 3.6.1 Audio Input

The Bronze Class IntelliPix adopt BNC port.

Due to high impedance of audio input, please use active sound pick-up. See Figure 3-4.

Audio transmission is similar to video transmission. Try to avoid interference, dry joint, loose contact and it shall be away from high tension current.

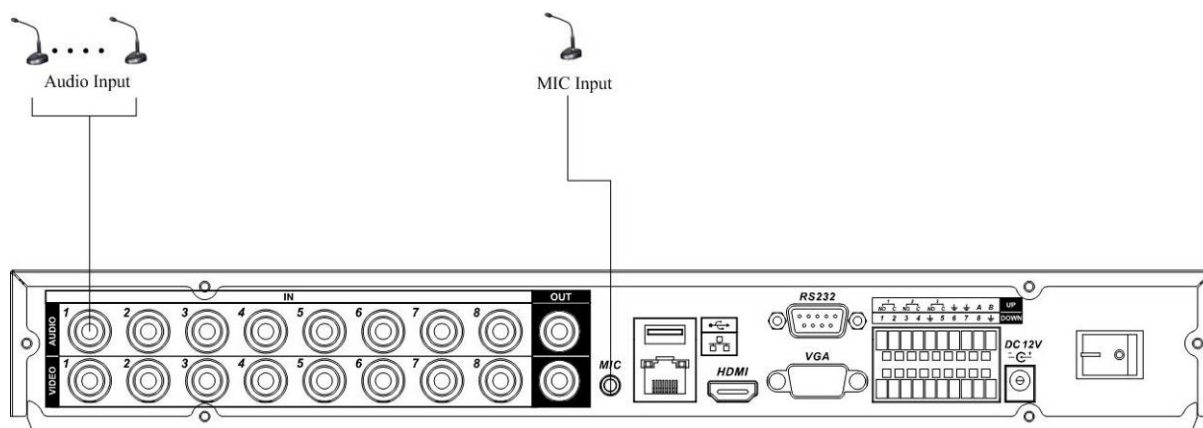

Figure 3-3

### 3.6.2 Audio Output

The audio output signal parameter is usually over 200mv 1K $\Omega$  (BNC). It can directly connect to low impedance earphone, active sound box or amplifier-drive audio output device.

If the sound box and the pick-up cannot be separated spatially, it is easy to arouse squeaking. In this case you can adopt the following measures:

- Use better sound pick-up with better directing property.
- Reduce the volume of the sound box.
- Using more sound-absorbing materials in decoration can reduce voice echo and improve acoustics environment.
- Adjust the layout to reduce happening of the squeaking.

Please refer to Figure 3-4.

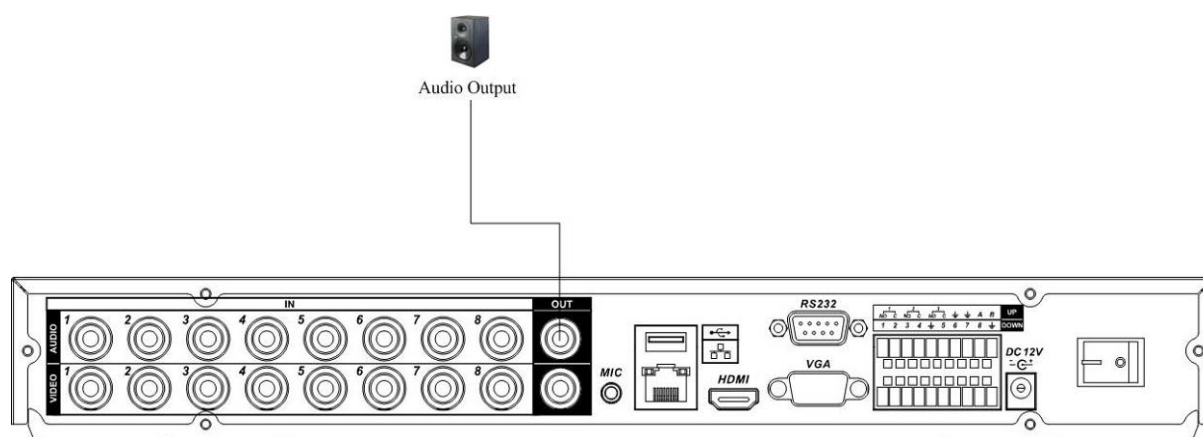

Figure 3-4

### 3.7 Alarm Input and Output Connection

Please refer to the following sheet for alarm input and output connection. See Figure 3-5.

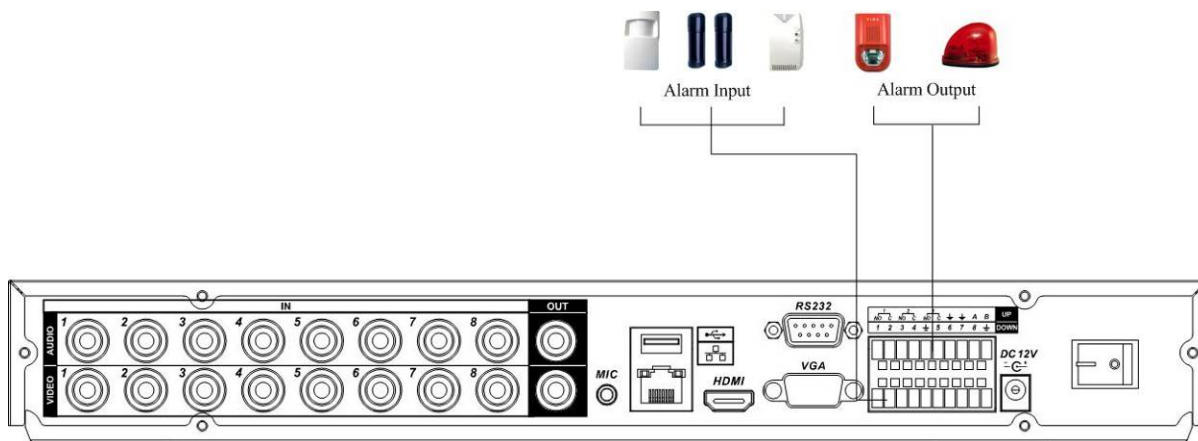

Figure 3-5

There are two alarm input types for you to select: normal open (NO) and normal close (NC).

### 1. Alarm input

- a. Please make sure alarm input mode is grounding alarm input.
- b. Grounding signal is needed for alarm input.
- c. When you are connecting two DVRs or you are connecting one DVR and one other device, please use a relay to separate them,

### 2. Alarm output

The alarm output port should not be connected to high power load directly (It shall be less than 1A) to avoid high current which may result in relay damage. Please use the co contactor to realize the connection between the alarm output port and the load.

### 3. How to connect PTZ decoder

- a. Ensure the decoder has the same grounding with DVR, otherwise you may not control the PTZ. Shielded twisted wire is recommended and the shielded layer is used to connect to the grounding.
- b. Avoid high voltage. Ensure proper wiring and some thunder protection measures.
- c. For too long signal wires, 120Ω should be parallel connected between A, B lines on the far end to reduce reflection and guarantee the signal quality.
- d. “485 A, B” of DVR cannot parallel connect with “485 port” of other device.
- e. The voltage between of A,B lines of the decoder should be less than 5v.

### 4. Please make sure the front-end device has soundly earthed.

Improper grounding may result in chip damage.

## 3.7.1 Alarm Input and Output Details

You can refer to the following sheet and Figure 3-6 for alarm input and output information.

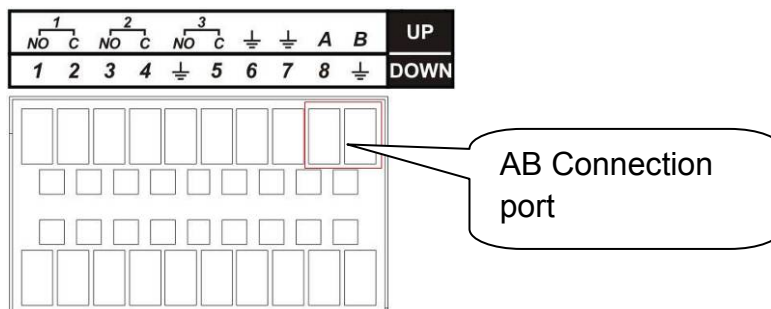



Figure 3-6

Parameter	Grounding Alarm
	Ground line
Alarm Input	1, 2, ..., 8. It becomes valid in low voltage.
1-NO C, 2-NO C, 3-NO C	Three NO activation outputs.
Relay Output	1,2,3,4: NO and C(Normally Open and Com) 5: NO,C and NC(Normally Open, Com, Normally Closed) 6: Ctrl 12V(This is used for reset the sensor)
485 A/B	485 communication port. They are used to control devices such as PTZ. Please parallel connect 120Ω between A/B cables if there are too many PTZ decoders.

### 3.7.2 Alarm Input Port

Please refer to the following sheet for more information.

- 4/8/16-ch grounding alarm inputs. (Normal open or Normal close type)
- Please parallel connect COM end and GND end of the alarm detector (Provide external power to the alarm detector).
- Please parallel connect the Ground of the DVR and the ground of the alarm detector.
- Please connect the NC port of the alarm sensor to the DVR alarm input(ALARM)
- Use the same ground with that of DVR if you use external power to the alarm device.

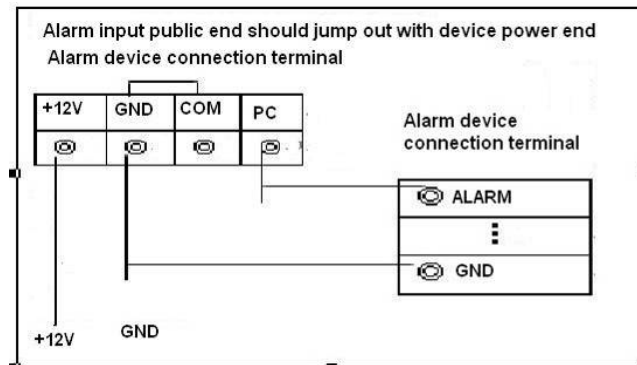

Figure 3-7

### 3.7.3 Alarm Output Port

- 3 ways relay alarm output (NO contact). Provide external power to external alarm device.
- To avoid overloading, please read the following relay parameters sheet carefully.
- RS485 A/B cable is for the A/B cable of the PTZ decoder.

### Relay Specification

<b>Model:</b>	<b>JRC-27F</b>	
Material of the touch	Silver	
Rating (Resistance Load)	Rated switch capacity	30VDC 2A, 125VAC 1A
	Maximum switch power	125VA 160W
	Maximum switch voltage	250VAC, 220VDC

	Maximum switch current	1A
Insulation	Between touches with same polarity	1000VAC 1minute
	Between touches with different polarity	1000VAC 1minute
	Between touch and winding	1000VAC 1minute
Surge voltage	Between touches with same polarity	1500V (10×160us)
Length of open time	3ms max	
Length of close time	3ms max	
Longevity	Mechanical	50×10 <sup>6</sup> times (3Hz)
	Electrical	200×10 <sup>3</sup> times (0.5Hz)
Temperature	-40°C ~+70°C	

### 3.8 RS232

You can connect the DVR with POS or Keyboard through RS232.

With POS system, the DVR can communicate through RS232 and network. For the POS system, the DVR can integrate the text content and even search the record through the info.

The Bronze Class IntelliPix also supports NKB operation. You can operate the DVR from the keyboard controls instead of using the control pad on the front panel of the unit.

To connect a NKB keyboard to the DVR:

1. Assemble the KBD keyboard according to the instructions in its accompanying installation manual.
2. Connect the KBD keyboard into one of the RS232 ports on the DVR or through network.

### 3.9 RS485

When the DVR receives a camera control command, it transmits that command up the coaxial cable to the PTZ device. RS485 is a single-direction protocol; the PTZ device can't return any data to the unit. To enable the operation, connect the PTZ device to the RS485 (A,B) input on the DVR. See Figure 3-8.

Since RS485 is disabled by default for each camera, you must enable the PTZ settings first. The Bronze Class IntelliPix supports multiple protocols such as Pelco-D, Pelco-P.

To connect PTZ devices to the DVR:

1. Connect RS485 A,B on the DVR rear panel.
2. Connect the other end of the cable to the proper pins in the connector on the camera.
3. Please follow the instructions to configure a camera to enable each PTZ device on the DVR.

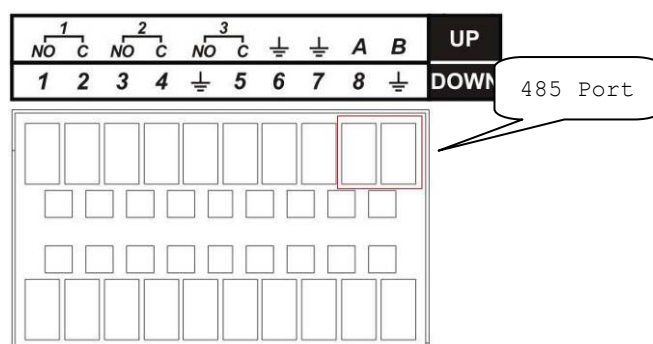



Figure 3-8

### 3.10 Other Interfaces

There are still other interfaces on the DVR, such as USB ports. You can refer to the Figure 3-9 for more information.

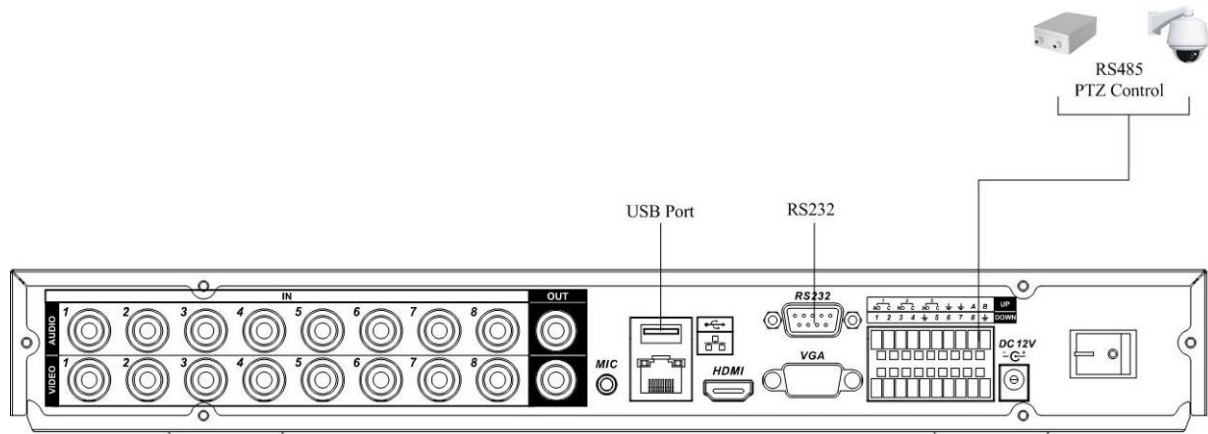

Figure 3-9



## 4 Overview of Navigation and Controls

Before operation, please make sure you have properly installed HDD and all the cable connections.

### 4.1 Login, Logout & Main Menu

#### 4.1.1 Login

After system booted up, default video display is in multiple-window mode.

Click Enter or left click mouse, you can see the login interface. See Figure 4-1.

System consists of four accounts:

- **Username:** admin. **Password:** admin. (administrator, local and network)
- **Username:** 888888. **Password:** 888888. (administrator, local only)
- **Username:** 666666. **Passwords:** 666666 (Lower authority user who can only monitor, playback, backup and etc.)
- **Username:** default. **Password:** default (hidden user)

You can use USB mouse, front panel, remote control or keyboard to input. About input method:

Click **123** to switch between numeral, English character (small/capitalized) and denotation.

#### Note:

**For security reason, please modify password after you first login.**

Within 30 minutes, three times login failure will result in system alarm and five times login failure will result in account lock!



Figure 4-1

#### 4.1.2 Main Menu

After you logged in, the system main menu is shown as below. See Figure 4-2.

There are total six icons: search, information, setting, backup, advanced and shutdown.

You can move the cursor to highlight the icon, and then double click mouse to enter the sub-menu.

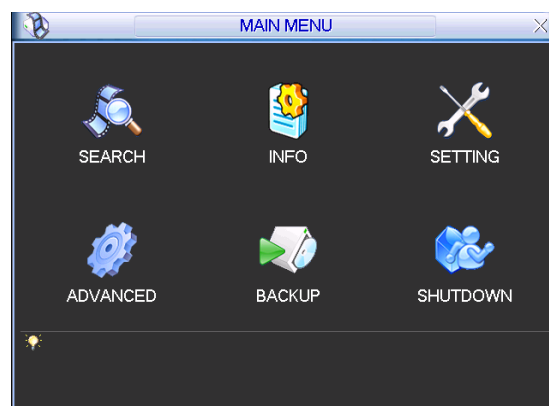

Figure 4-2

### 4.1.3 Logout

There are two ways for you to log out.

One is from menu option:

In the main menu, click shutdown button, you can see an interface is shown as below. See Figure 4-3.

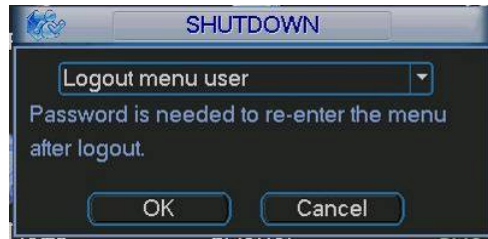

Figure 4-3

There are several options for you. See Figure 4-4.

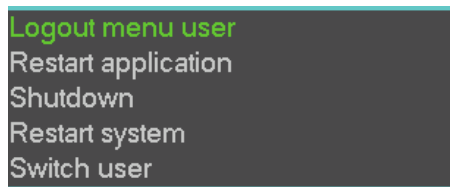

Figure 4-4

The other ways is to press power button on the front panel for at least 3 seconds, system will stop all operations. Then you can click the power button in the rear panel to turn off the DVR.

### 4.1.4 Auto Resume after Power Failure

The system can automatically backup video and resume previous working status after power failure.

### 4.1.5 Replace Button Battery

Please make sure to use the same battery model if possible.

We recommend replace battery regularly (such as one-year) to guarantee system time accuracy.

## 4.2 Manual Record

### 4.2.1 Live Viewing

After you logged in, the system is in live viewing mode. You can see system date, time and channel name. If you want to change system date and time, you can refer to general settings (Main Menu->Setting->General). If you want to modify the channel name, please refer to the display settings (Main Menu->Setting->Display)

1		Recording status	3		Video loss
2		Motion detection	4		Camera lock

### 4.2.2 Manual record

Note:

You need to have proper rights to implement the following operations. Please make sure the HDD has been properly installed.

#### 4.2.2.1 Manual record menu

There are two ways for you to go to manual record menu.

- Right click mouse or in the main menu, Advanced->Manual Record.
- In live viewing mode, click record button in the front panel or record button in the remote control.

Manual record menu is shown as in Figure 4-5.

#### 4.2.2.2 Basic operation

There are three statuses: schedule/manual/stop. Please highlight icon “○” to select corresponding channel.

- Manual: The highest priority. After manual setup, all selected channels will begin ordinary recording.
- Schedule: Channel records as you have set in recording setup (Main Menu->Setting->Schedule)
- Stop: All channels stop recording.



Figure 4-5

#### 4.2.2.3 Enable/disable record

Please check current channel status: “○” means it is not in recording status, “●” means it is in recording status.

You can use mouse or direction key to highlight channel number. See Figure 4-6.

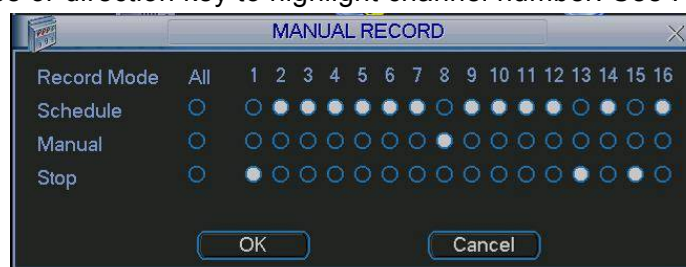

Figure 4-6

#### 4.2.2.4 Enable all channel recording

Highlight ○ below All, you can enable all channel recording.

- All channel schedule record

Please highlight “ALL” after “Schedule”. See Figure 4-7.

When system is in schedule recording, all channels will record as you have previously set (Main menu->Setting->Schedule).

The corresponding indication light in front panel will turn on.

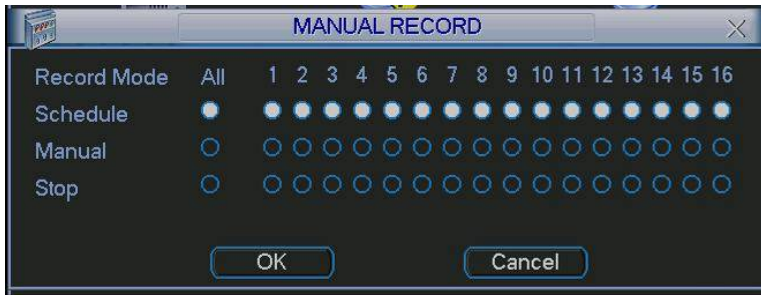

Figure 4-7

- All channel manual record

Please highlight “ALL” after “Manual.” See Figure 4-8.

When system is in manual recording, all scheduled set up you have set in will be null ((Main menu->Setting->Schedule)).

You can see indication light in front panel turns on, system begins manual record now.

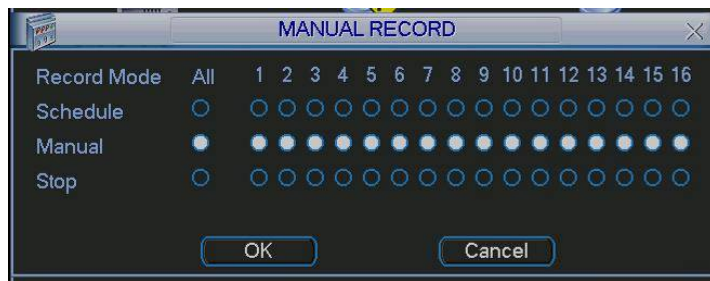

Figure 4-8

#### 4.2.2.5 Stop all channel recording

Please highlight “ALL” after “Stop”. See Figure 4-9.

System stops all channel recording no matter what mode you have set in the menu (Main menu->Setting->Schedule)

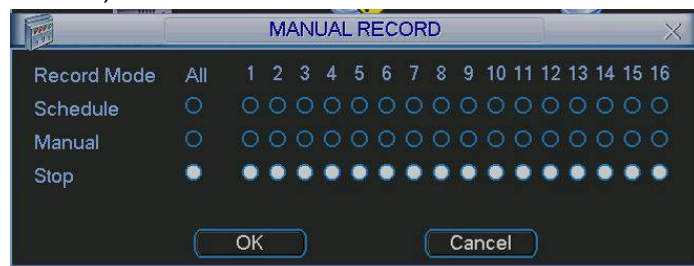

Figure 4-9

### 4.3 Search & Playback

#### 4.3.1 Search Menu

Click search button in the main menu, search interface is shown as below. See Figure 4-10.

Usually there are three file types:

- R: Regular recording file.
- A: External alarm recording file.

- M: Motion detection recording file

There are several playback windows. Usually system supports 1/2/3/4-ch playback.

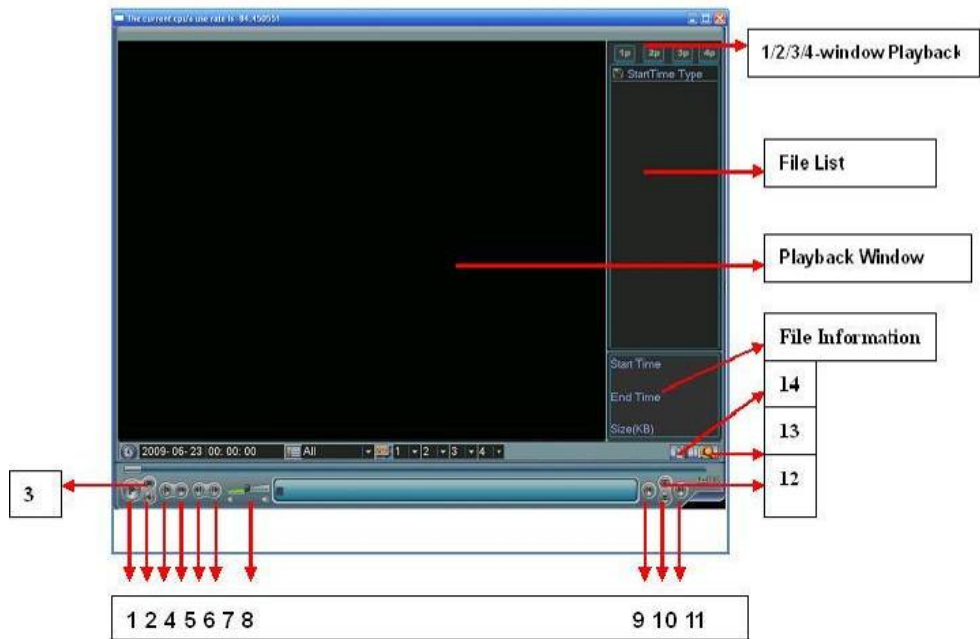

Figure 4-10

Please refer to the following sheet for more information.

Serial Number	Function
1	Play
2	Backward
3	Stop
4	Slow play
5	Fast play
6	Previous frame
7	Next frame
8	Volume
9	Previous file
10	Next channel
11	Next file
12	Previous channel
13	Search
14	Backup

## 4.3.2 Basic Operation

### 4.3.2.1 Playback

There are various search modes: video type, channel number or time. The system can max display 128 files in one screen. You can use page up/down button to view if there are more than one page.

Select the file name and double click mouse (or click enter button), you can view file content.

### 4.3.2.2 Accurate playback

Input time (h/m/s) in the time column and then click playback button, system can operate accurate playback.

### 4.3.2.3 Synchronized playback function when playback

During playback process, click numeral key, system can switch to the corresponding channel video of the same time.

#### 4.3.2.4 Digital zoom

When the system is in full-screen playback mode, drag your mouse in the screen to select a section and then left click mouse to realize digital zoom. You can right click mouse to exit.

#### 4.3.2.5 File backup

System supports backup operation during search. You can draw a √ before file name (multiple choices). Then click backup button (Button 14 in Figure 4-10).

#### 4.3.2.6 Slow playback and fast playback

Please refer to the following sheet for slow play and fast playback function.

Button	Illustration	Remarks
Fast play button ►►	In playback mode, click this button to switch between various fast play modes such as fast play 1, fast play 2 and more.	Frame rate may vary due to different versions.
Slow play button ►	In playback mode, click this button to switch between various slow play modes such as slow play 1 or slow play 2.	
Play/Pause ►	In slow playback mode, click this button to switch between play/pause modes.	
Previous/next	In playback mode, you can click  ◀ and ▶  to view previous or next video in current channel.	

#### 4.3.2.7 Backward playback and frame by frame playback

Button	Illustration	Remarks
Backward play:   ◀ in playback interface.	In normal playback mode, left click backward play button◀, system begins backward playback. Double click backward play button again, system goes to pause mode.	When system is in backward play or frame by frame playback mode, you can click play button►/    to go to normal playback.
Manual playback frame by frame.	Click pause button in normal playback mode, you can use ◀  and  ▶ to view frame by frame.	

Note:

All the operations here (such as playback speed, channel, time and progress) have relationship with hardware version. Some IntelliPix DVRs do not support some functions or playback speeds.

### 4.3.3 Calendar

Click calendar icon  in Figure 4-10, system pops up a calendar for your reference.

The highlighted date means there are record files in that day. You can click blue date to view file list.

In Figure 4-11, there are video files in March 13th and 14th. Double click the date to view file list.

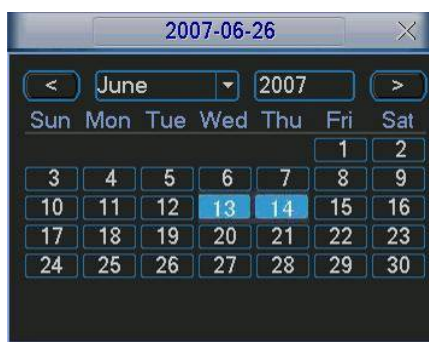

Figure 4-11

## 4.4 Schedule

After system booted up, it is in default 24-hour regular mode. You can set record type and time in schedule interface.

### 4.4.1 Schedule Menu

In the main menu, from setting to schedule, you can go to schedule menu. See Figure 4-12.

- Channel: Please select the channel number first. You can select “all” if you want to set for the whole channels.
- Week day: There are eight options: ranges from Saturday to Sunday and all.
- Pre-record: System can pre-record the video before the event occurs into the file. The value ranges from 1 to 30 seconds depending on the bit stream.
- Redundancy: Please note redundancy function **does not** applies to the Bronze Class IntelliPix DVR since there is only one HDD.
- Snapshot: You can enable this function to snapshot image when alarm occurs.
- Record types: There are three types: regular, motion detection (MD) and Alarm.

Please highlight icon  to select the corresponding function. After completing all the setups please click save button, system goes back to the previous menu.

At the bottom of the menu, there are color bars for your reference. Green color stands for regular recording, yellow color stands for motion detection and red color stands for alarm recording.

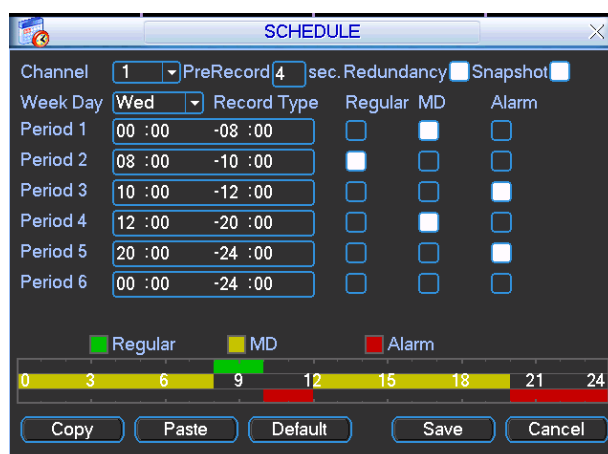

Figure 4-12

#### 4.4.1.1 Quick Setup



This function allows you to copy one channel setup to another. After setting in channel 1, you can click paste button and turn to channel 2 and then click copy button. You can finish setting for one channel and then click save button or you can finish all setup and then click save button to memorize all the settings.

## 4.4.2 Snapshot

### 4.4.2.1 Schedule Snapshot

In Encode interface, click snapshot button to input snapshot mode, size, quality and frequency.

In General interface please input upload interval.

In Schedule interface, please enable snapshot function.

Please refer to the following figure for detail information. See Figure 4-13

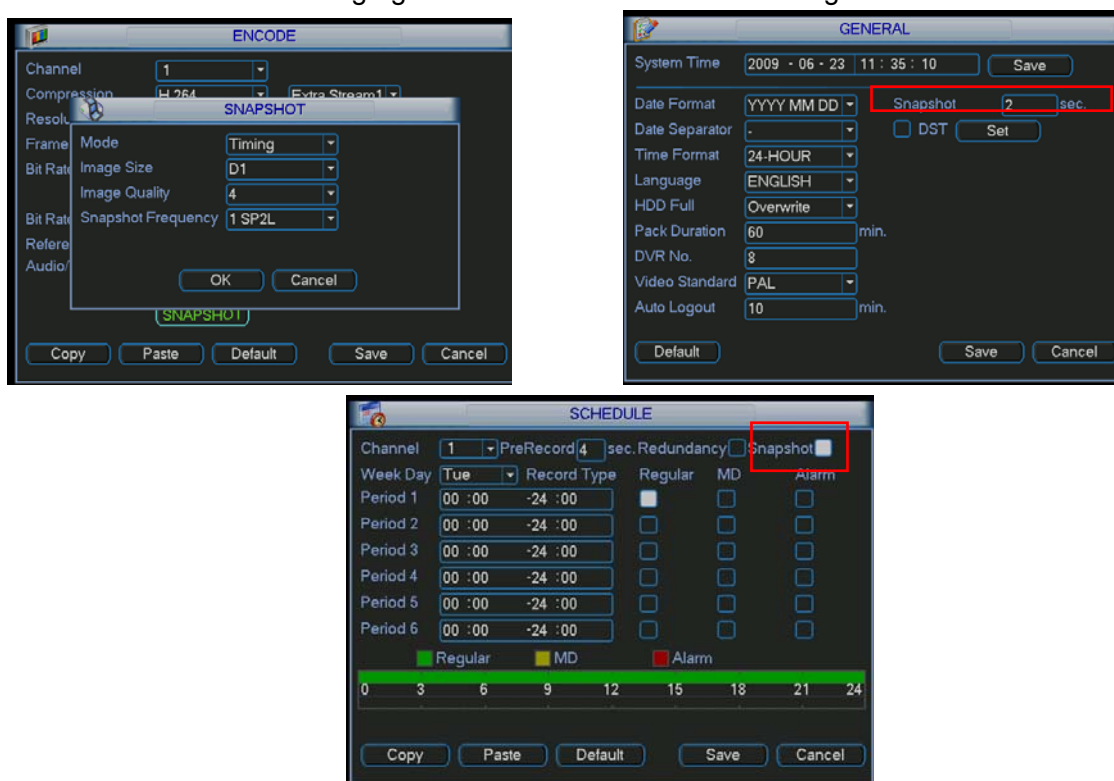

Figure 4-13

### 4.4.2.2 Activation Snapshot

In Encode interface, click snapshot button to input snapshot mode, size, quality and frequency.

In General interface please input upload interval.

In Detect interface please enable snapshot function for specified channels.

In Alarm interface please enable snapshot function for specified channels.

Please refer to the following figure for detail information. See Figure 4-14.



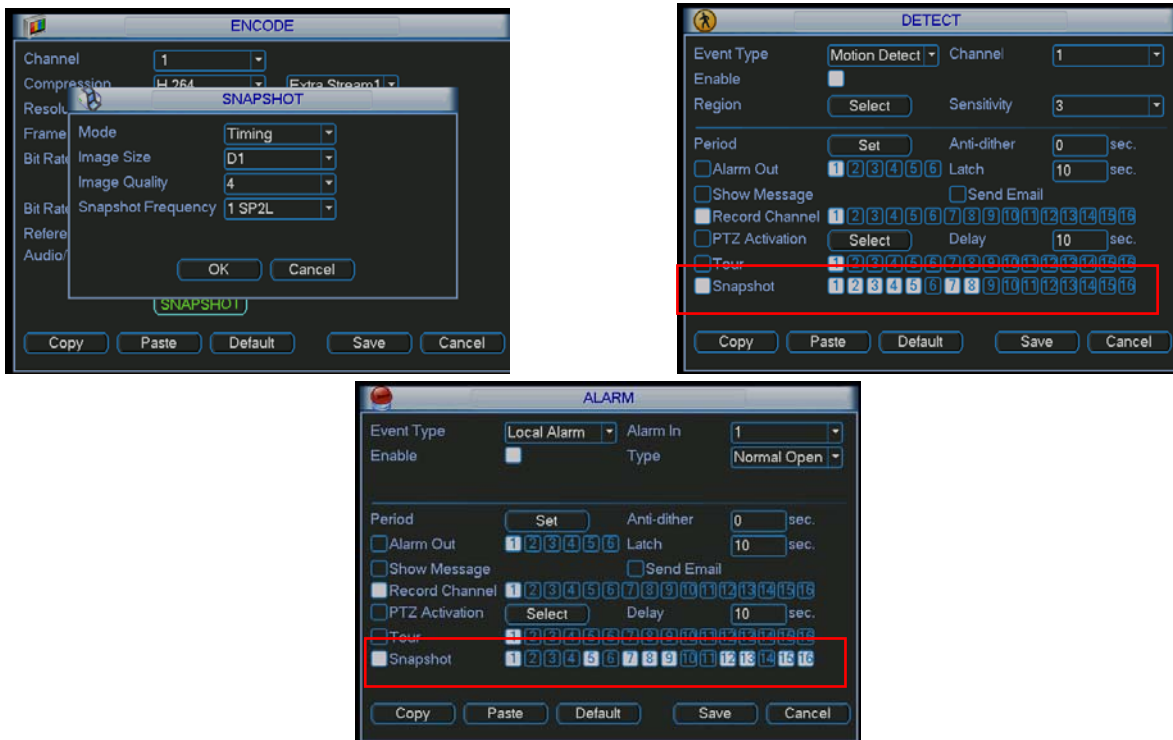

Figure 4-14

#### 4.4.2.3 Priority

Please note the activation snapshot has the higher priority than schedule snapshot. If you have enabled these two types at the same time, system can activate the activation snapshot when alarm occurs, and otherwise system just operates the schedule snapshot.

#### 4.4.3 Image FTP

In Network interface, you can set FTP server information. Please enable FTP function and then click save button. See Figure 4-15.

Please boot up corresponding FTP server.

Please enable schedule snapshot (Chapter 4.4.2.1) or activation snapshot (Chapter 4.4.2.2) first, now system can upload the image file to the FTP server.

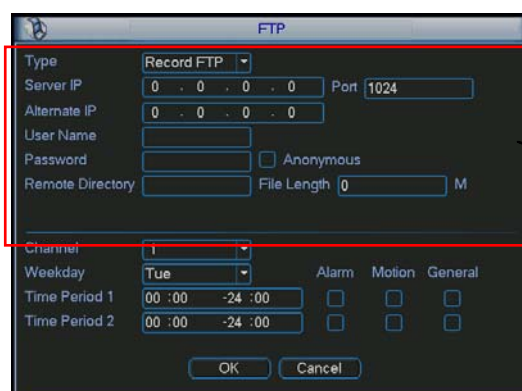

Please input the corresponding information here, if you just upload the image FTP.

Figure 4-15

## 4.5 Detect

### 4.5.1 Go to Detect Menu

In the main menu, from Setting to Detect, you can see motion detect interface. See Figure 4-16. There are three detection types: motion detection, video loss, camera masking.

#### 4.5.2 Motion Detect

Detection menu is shown as below. See Figure 4-16.

- Event type: from the dropdown list you can select motion detection type.
- Channel: select the channel to activate recording function once alarm occurred. Please make sure you have set MD record in encode interface(Main Menu->Setting->Schedule) and schedule record in manual record interface(Main Menu->Advanced->Manual Record)
- Latch: when motion detection complete, system auto delays detecting for a specified time. The value ranges from 10-300(Unit: second)
- Region: Click select button, the interface is shown as in Figure 4-17.Here you can set motion detection zone. There are 396(PAL)/330(NTSC) small zones.
- Sensitivity: System supports 6 levels. The sixth level has the highest sensitivity.
- Show message: System can pop up a message to alarm you in the local host screen if you enabled this function.
- Send email: System can send out email to alert you when alarm occurs.
- PTZ activation: Here you can set PTZ movement when alarm occurs. Such as go to preset, tour &pattern when there is an alarm. Click “select” button, you can see an interface is shown as in Figure 4-18.
- Period: Click set button, you can see an interface is shown as in Figure 4-19. Here you can set for business day and non-business day. In Figure 4-19, click set button, you can see an interface is shown as in Figure 4-20. Here you can set your own setup for business day and non-business day.
- Anti-dither: Here you can set anti-dither time.
- Alarm output: when alarm occurred, system enables peripheral alarm devices.
- Tour: Here you can enable tour function when alarm occurs. It is a one-window tour. Please go to chapter 5.3.9 Display for tour interval setup.

Please highlight icon  to select the corresponding function. After all the setups please click save button, system goes back to the previous menu.

#### **Note:**

In motion detection mode, you can not use copy/paste to set channel setup since the video in each channel may not be the same.

In Figure 4-17, you can left click mouse and then drag it to set a region for motion detection.

Click Fn to switch between arm/withdraw motion detection. After setting, click enter button to exit.

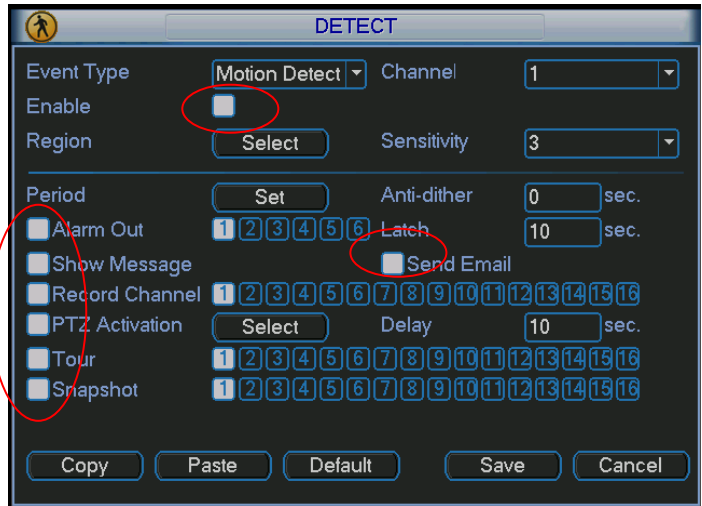

Figure 4-16

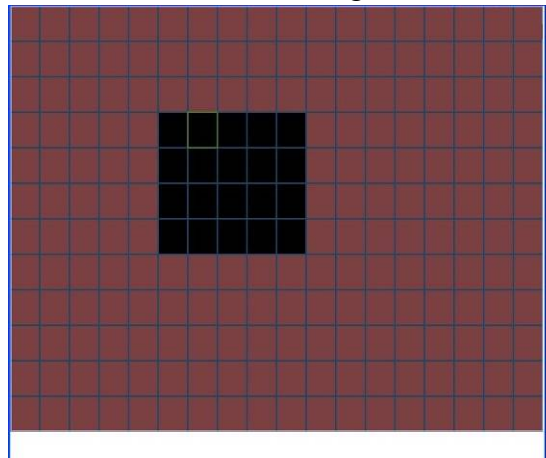

Figure 4-17

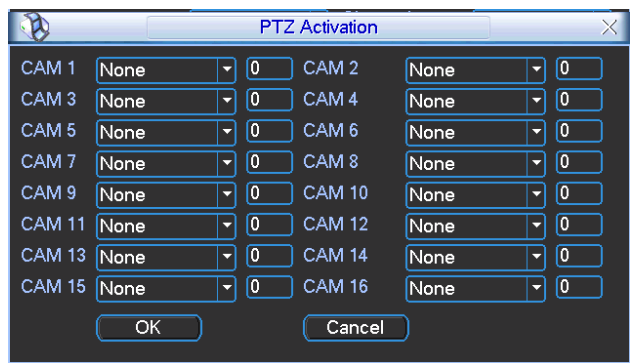

Figure 4-18

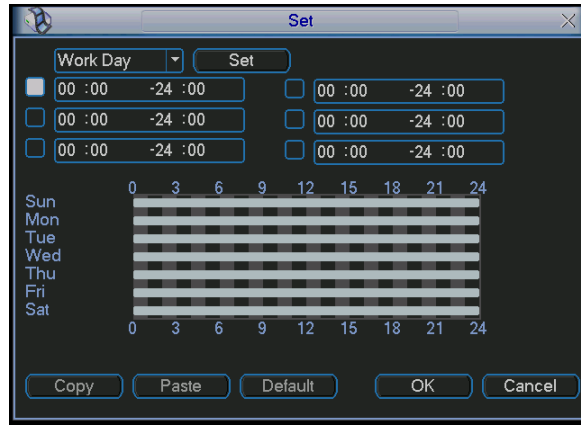

Figure 4-19

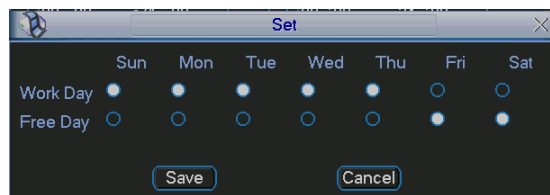

Figure 4-20

### 4.5.3 Video Loss

In Figure 4-16, select video loss from the type list. You can see the interface is shown as in Figure 4-21. This function allows you to be informed when video loss phenomenon occurred. You can enable alarm output channel and then enable show message function.

**Tips:**

You can enable preset activation operation when video loss occurs. Please refer to chapter 4.5.2 motion detection for detail information.

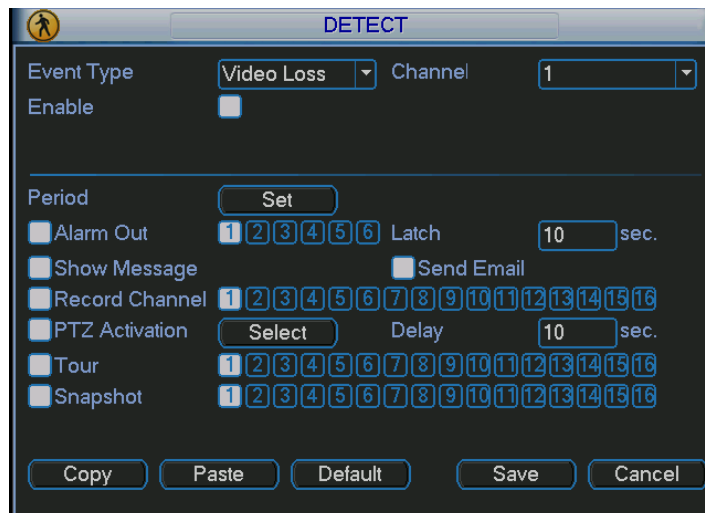

Figure 4-21

### 4.5.4 Camera Masking

When someone viciously masks lens, the system can alert you to guarantee video continuity. Camera masking interface is shown as in Figure 4-22.

### Tips:

You can enable preset/tour/pattern activation operation when video loss occurs. Please refer to chapter 4.5.2 motion detection for detail information.

### Note:

In Detect interface, copy/paste function is only valid for the same type, which means you can not copy a channel setup in video loss mode to camera masking mode.

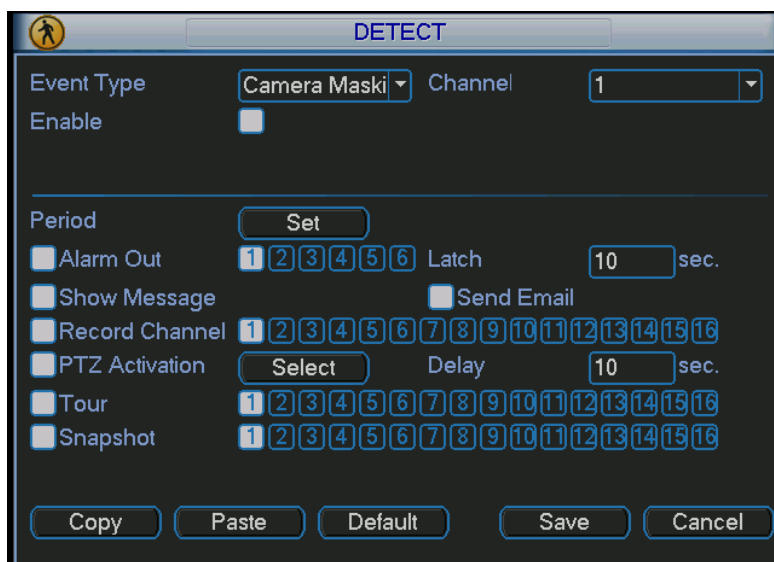

Figure 4-22

## 4.6 Alarm Setup and Alarm Activation

Before operation, please make sure you have properly connected alarm devices such as buzzer.

### 4.6.1 Go to alarm setup interface

In the main menu, from Setting to Alarm, you can see alarm setup interface. See Figure 4-23.

### 4.6.2 Alarm setup

Alarm interface is shown as below. See Figure 4-23.

- Alarm in: here is for you to select channel number.
- Event type: there are two types. One is local input and the other is network input.
- Type: normal open or normal close.
- PTZ activation: Here you can set PTZ movement when alarm occurs. Such as go to preset, tour& pattern when there is an alarm. Click "select" button, you can see an interface is shown as in Figure 4-27.
- Period: Click set button, you can see an interface is shown as in Figure 4-25. Here you can set for business day and non-business day. In Figure 4-28, click set button, you can see an interface is shown as in Figure 4-29. Here you can set your own setup for business day and non-business day.
- Anti-dither: Here you can set anti-dither time.
- Show message: System can pop up a message to alarm you in the local host screen if you enabled this function.
- Send email: System can send out email to alert you when alarm occurs.
- Record channel: you can select proper channel to record alarm video (Multiple choices). At the same time you need to set alarm record in schedule interface (Main Menu->Setting-

>Schedule) and select schedule record in manual record interface (Main Menu->Advance->Manual Record).

- Latch: Here is for you to set proper delay duration. Value ranges from 10 to 300 seconds. System automatically delays specified seconds in turning off alarm and activated output after external alarm cancelled.
- Tour: Here you can enable tour function when alarm occurs. It is a one-window tour: Please go to chapter 5.3.9 Display for tour interval setup.

For snapshot operation, please refer to chapter 4.4.2.

Please highlight icon  to select the corresponding function. After setting all the setups please click save button, system goes back to the previous menu.

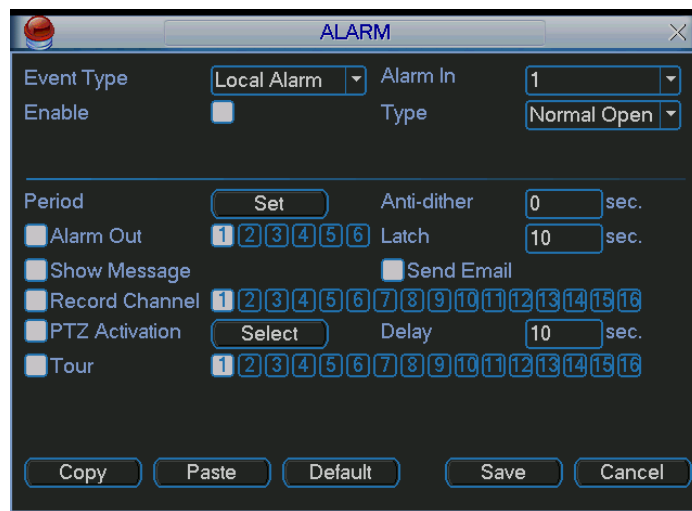

Figure 4-23

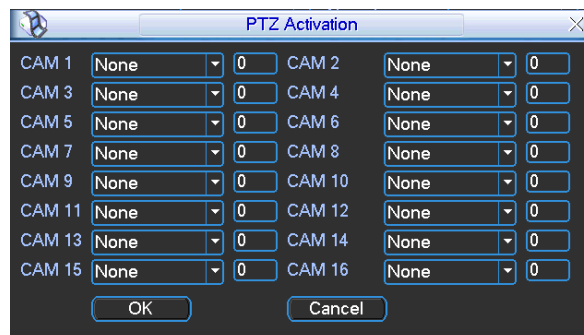

Figure 4-24

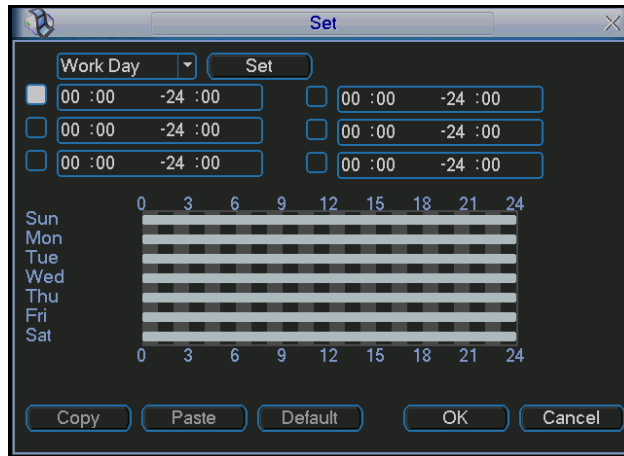

Figure 4-25

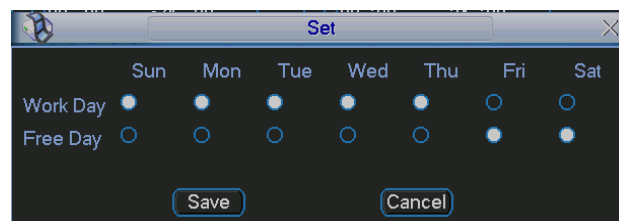

Figure 4-26

## 4.7 Backup

DVR support various backup devices such as CD-RW, DVD driver, USB backup and network download. Here we introduce USB backup first. You can refer to Chapter 7 Web Client Operation for network download backup operation.

Please note, the flash disk or portable HDD shall be FAT or FAT 32 file system.

### 4.7.1 Detect Device

Click backup button, you can see an interface is shown as in Figure 4-27. Here is for you to view devices information.

You can view backup device name and its total space and free space. The device includes USB burner, flash disk, SD card and portable HDD.

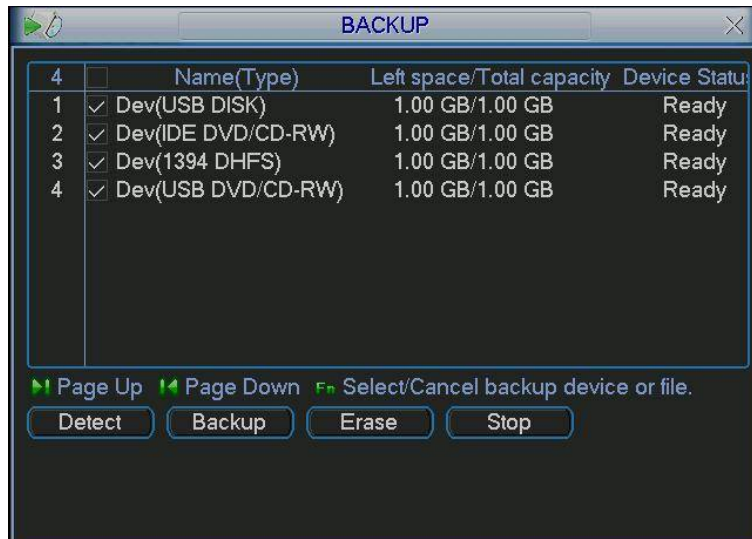

Figure 4-27

#### 4.7.1 Backup

Select backup device and then set channel, file start time and end time.

Click add button, system begins search. All matched files are listed below. System automatically calculates the capacity needed and remained. See Figure 4-28.

system only backup files with a ✓ before channel name. You can use Fn or cancel button to delete ✓ after file serial number.

Click backup button, you can backup selected files. There is a process bar for you reference. When the system completes backup, you can see a dialogue box prompting successful backup.

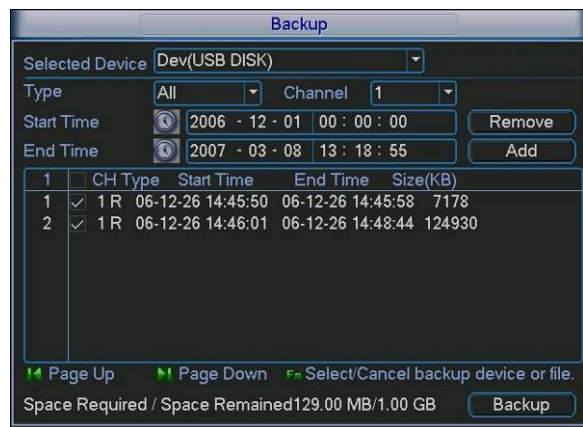

Figure 4-28

Click backup button, system begins burning. At the same time, the backup button becomes stop button. You can view the remaining time and process bar at the left bottom. See Figure 4-29.

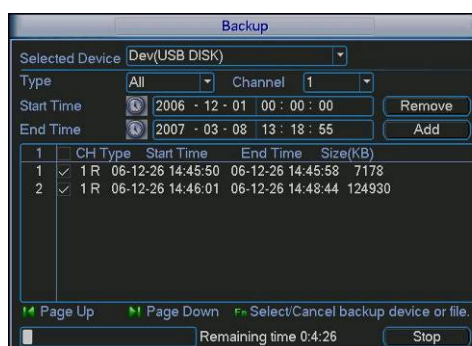



Figure 4-29

The file name format usually is: SN\_CH+channel number+time Y+M+D+H+M+S. In the file name, the YDM format is the same as you set in general interface. (Main Menu ->Setting ->General).File extension name is .dav. You can visit our website to view listed CD-ROM brand.

**Tips:**

During backup process, you can click ESC to exit current interface for other operation. The system will not terminate backup process.

**Note:**

When you click stop button during the burning process, the stop function becomes activated immediately. For example, if there are ten files, when you click stop system just backup five files, system only save the previous 5 files in the device (But you can view ten file names).

## 4.8 PTZ Control and Color Setup

**Note:** All the operations here are based on PELCOD protocol. For other protocols, there might be a little difference.

### 4.8.1 Cable Connection

Please follow the procedures below to go on cable connection

- Connect the dome RS485 port to DVR 485 port.
- Connect dome video output cable to DVR video input port.
- Connect power adapter to the dome.

### 4.8.2 PTZ Setup

**Note:** The camera video should be in the current screen. Before setup, please check the following connections are right:

- PTZ and decoder connection is right. Decoder address setup is right.
- Decoder A (B) line connects with DVR A (B) line.

Boot up the DVR, input user name and password.

In the main menu, click setting, and then click Pan/Tilt Control button. The interface is shown as in Figure 4-30. Here you can set the following items:

- Channel: select the current camera channel.
- Protocol: select corresponding PTZ protocol(such as PELCOD)
- Address: default address is 1.
- Baud rate: select corresponding baud rate. Default value is 9600.
- Data bits: select corresponding data bits. Default value is 8.
- Stop bits: select corresponding stop bits. Default value is 1.
- Parity: there are three options: odd/even/none. Default setup is none.

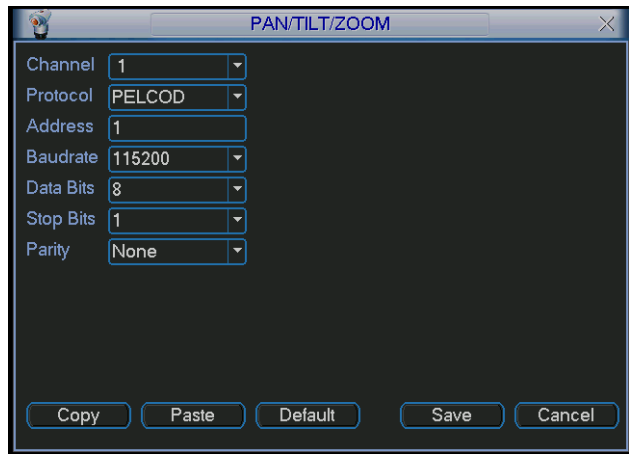

Figure 4-30

After completing all the setting please click save button.

In one window display mode, right click mouse (click “Fn” Button in the front panel or click “Fn” key in the remote control). The interface is shown as in Figure 4-31.



Figure 4-31

Click Pan/Tilt/Zoom, the interface is shown as below. See Figure 4-32.

Here you can set the following items:

- Step: value ranges fro 1 to 8.
- Zoom
- Focus
- Iris



Please click icon  and  to adjust zoom, focus and iris.



Figure 4-32

In Figure 4-32, please click direction arrows (See Figure 4-33) to adjust PTZ position. There are total 8 direction arrows.



Figure 4-33

### 4.8.3 3D Intelligent Positioning Key

In the middle of the eight direction arrows, there is a 3D intelligent positioning key. See Figure 4-34. Please make sure your protocol supports this function and you need to use mouse to control.

Click this key, system goes back to the single screen mode. Drag the mouse in the screen to adjust section size. It can realize PTZ automatically.



Figure 4-34

Here is a sheet for you reference.

Name	Function key	function	Shortcut key	Function key	function	Shortcut Key
Zoom		Near			Far	
Focus		Near			Far	
Iris		close			Open	

## 4.9 Preset/ Patrol/Pattern/Scan

In Figure 4-32, click the “set” button. The interface is shown as below. See Figure 4-35.

Here you can set the following items:

- Preset
- Tour
- Pattern
- Border

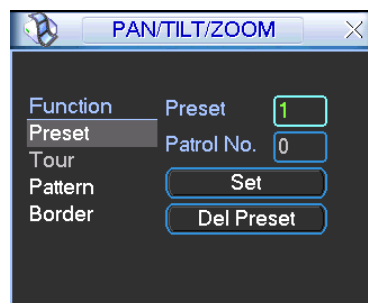

Figure 4-35

In Figure 4-32, click page switch button, the interface is shown as in Figure 4-36.

Here you can activate the following functions:

- Preset

- Tour
- Pattern
- Auto scan
- Auto pan
- Flip
- Reset
- Page switch

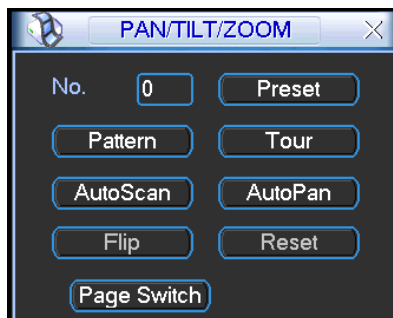

Figure 4-36

**Note:**

- Preset, tour and pattern all need the value to be the control parameter. You can define it as you require.
- You need to refer to your speed dome user's manual for Aux definition. In some cases, it can be used for special process.
- The following setups are usually operated in the Figure 4-32, Figure 4-35 and Figure 4-36 .

**4.9.1Preset Setup**

In Figure 4-32, use eight direction arrows to adjust camera to the proper position.

In Figure 4-35, click preset button and input preset number. The interface is shown as in Figure 4-37.

Now you can add this preset to one tour.



Figure 4-37

**4.9.2 Activate Preset**

In Figure 4-36, please input preset number in the No. blank, and click preset button.

**4.9.3 Patrol setup (Tour Setup)**

In Figure 4-35, click patrol button. The interface is shown as in Figure 4-38. Input preset number and add this preset to a patrol (tour). For each patrol (tour), you can input max 80 presets.



Figure 4-38

#### 4.9.4 Activate Patrol (tour)

In Figure 4-35, input patrol (tour) number in the No. blank and click patrol button

#### 4.9.5 Pattern Setup

In Figure 4-35, click pattern button and then click “begin” button. The interface is shown as in Figure 4-39. Then you can go to Figure 4-32 to modify zoom, focus, and iris.

Go back to Figure 4-39 and click “end” button. You can memorize all these operations as pattern 1.



Figure 4-39

#### 4.9.6 Activate Pattern Function

In Figure 4-36, input mode value in the No. blank, and click pattern button.

#### 4.9.7 Auto Scan Setup

In Figure 4-35, click border button. The interface is shown as in Figure 4-30.

Please go to Figure 4-32, use direction arrows to select camera left limit

Then please go to Figure 4-40 and click left limit button

Repeat the above procedures to set right limit.



Figure 4-40

### 4.9.8 Activate Auto Scan

In Figure 4-36, click “Auto Scan” button, the system begins auto scan. Correspondingly, the auto scan button becomes Stop button. Click stop button to terminate scan operation.

### 4.10 Flip

In Figure 4-36, click page switch button, you can see an interface is shown as below. See Figure 4-41. Here you can set auxiliary function. The aux value has relationship with the Aux button of the decoder.

Click page switch button again, system goes back to Figure 4-32.

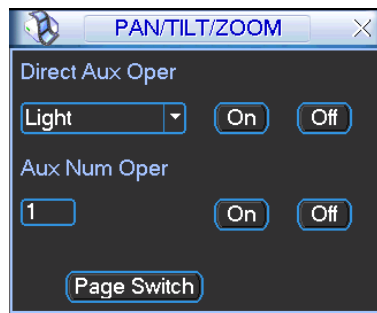
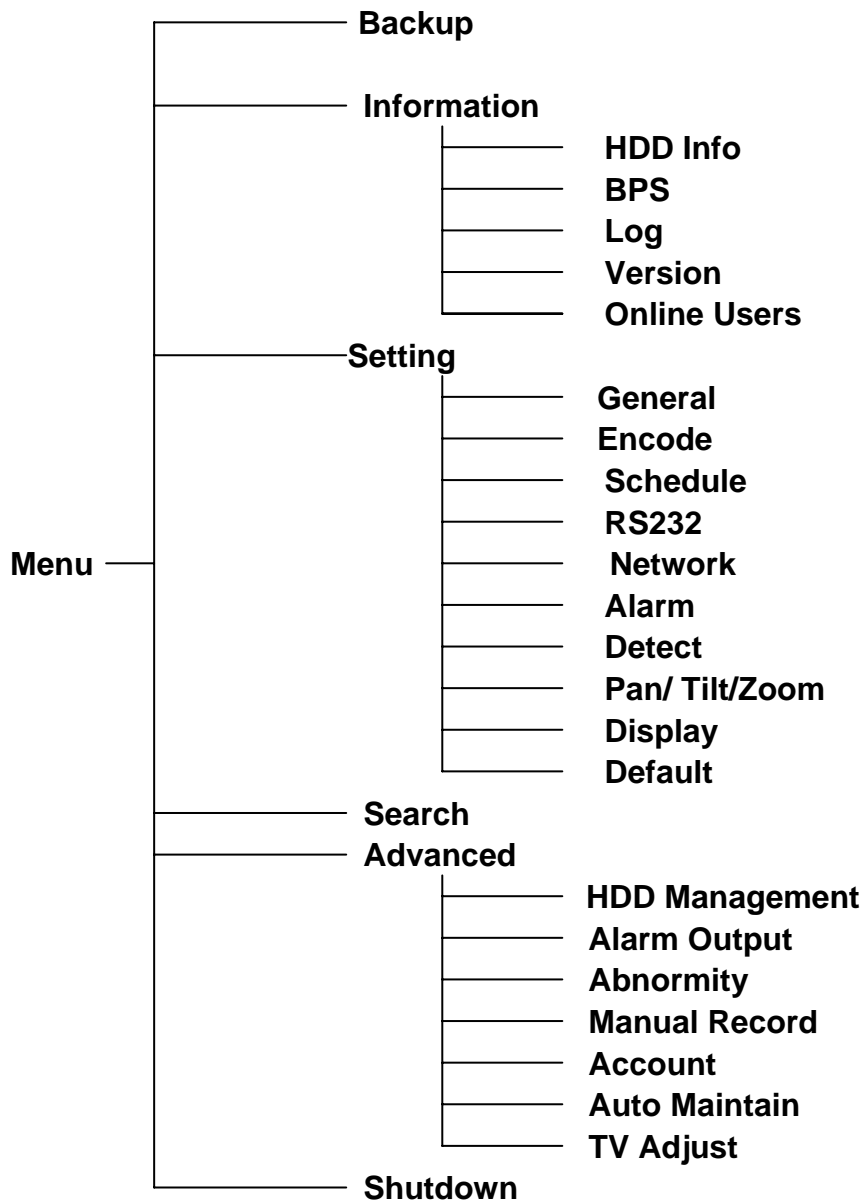

Figure 4-41

## 5 Understanding of Menu Operations and Controls

### 5.1 Menu Tree

The Bronze Class IntelliPix DVR menu tree is shown as below.



### 5.2 Main Menu

After you logged in, the system main menu is shown as below. See Figure 5-1. There are total six icons: search, Information, setting, backup, advanced and shutdown. Move the cursor to highlight the icon, then double click mouse to enter the sub-menu.

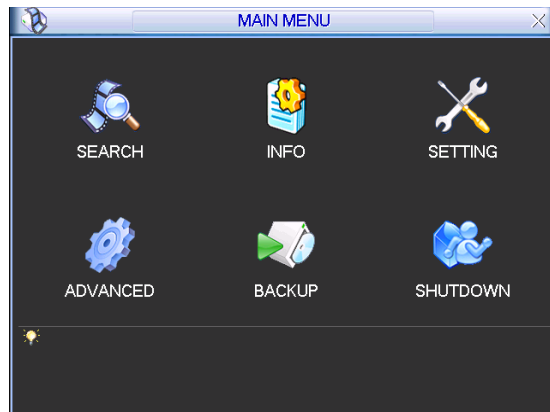

Figure 5-1

## 5.3 Setting

In main menu, highlight setting icon and double click mouse. System setting interface is shown as below. See Figure 5-2.

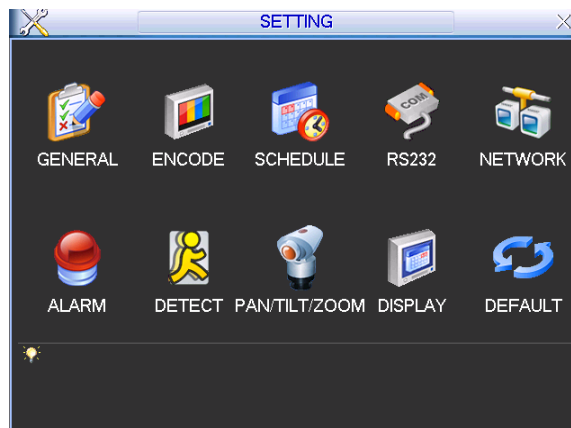

Figure 5-2

### 5.3.1 General

General setting includes the following items. See Figure 5-3.

- System time: Here is for you to set system time
- Date format: There are three types: YYYY-MM-DD: MM-DD-YYYYY or DD-MM-YYYY.
- Date separator: There are three denotations to separate date: dot, beeline and solidus.
- DST: Here you can set DST time and date. Please enable DST function and then click set button. You can see an interface is shown as in Figure 5-4. Here you can set start time and end time by setting corresponding week setup. In Figure 5-4, enable date button, you can see an interface is shown as in Figure 5-5. Here you can set start time and end time by setting corresponding date setup.
- Time format: There are two types: 24-hour mode or 12-hour mode.
- Language: System supports various languages: Chinese (simplified), Chinese (Traditional), English, Italian, Japanese, French, Spanish (All languages listed here are optional. Slight difference maybe found in various classes.)
- HDD full: Here is for you to select working mode when hard disk is full. There are two options: stop recording or rewrite.



- Pack duration: Here is for you to specify record duration. Default value is 60 minutes.
- DVR No: When you are using one remote control (not included in the accessory bag) to control several DVRs, you can give a name to each DVR for your management.
- Video standard: There are two formats: NTSC and PAL.
- Auto logout: Here is for you to set auto logout interval once login user remains inactive for a specified time. Value ranges from 0 to 60 minutes.

**Note:**

Since system time is very important, do not modify time casually unless there is a must!

Before your time modification, please stop record operation first!

After completing all the setups please click save button, system goes back to the previous menu.

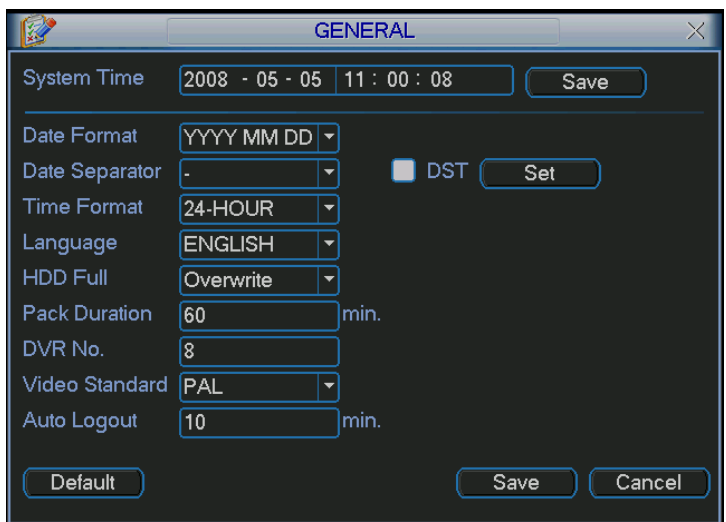

Figure 5-3

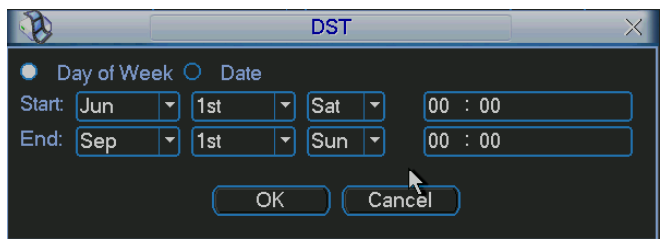

Figure 5-4

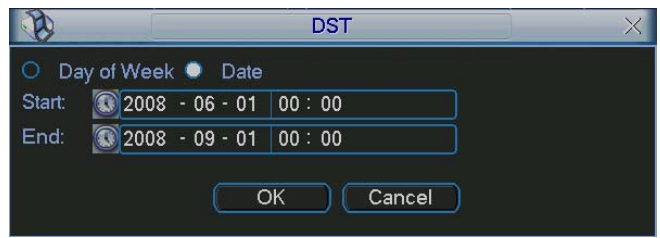

Figure 5-5

**5.3.2 Encode**

Encode setting includes the following items. See Figure 5-6.

Please note some classes of IntelliPix DVR do not support extra stream.

- Channel: Select the channel you want.

- Compression: System supports H.264.
- Resolution: System supports various resolutions, you can select from the dropdown list. For this model, we can support D1/CIF/QCIF.
- Bit rate: System supports two types: CBR and VBR. In VBR mode, you can set video quality.
- Quality: There are six levels ranging from 1 to 6. The sixth level has the highest image quality.
- Frame rate: there are six levels: 1 f/s, 2f/s, 3f/s, 6f/s, 12f/s, 25f/s.
- Video/audio: You can enable or disable the video/audio.
- Overlay: Click overlay button, you can see an interface is shown in Figure 5-7.
- ✧ Cover area (Privacy mask): Here is for you to set privacy mask section. You can drag you mouse to set proper section size. In one channel video, system max supports 4 zones.
- ✧ Preview/monitor: privacy mask has two types. Preview and Monitor. Preview means the privacy mask zone can not be viewed by user when system is in preview status. Monitor means the privacy mask zone can not be view by the user when system is in monitor status.
- ✧ Time display: You can select system displays time or not when you playback. Please click set button and then drag the title to the corresponding position in the screen.
- ✧ Channel display: You can select system displays channel number or not when you playback. Please click set button and then drag the title to the corresponding position in the screen.

Please highlight icon  to select the corresponding function.

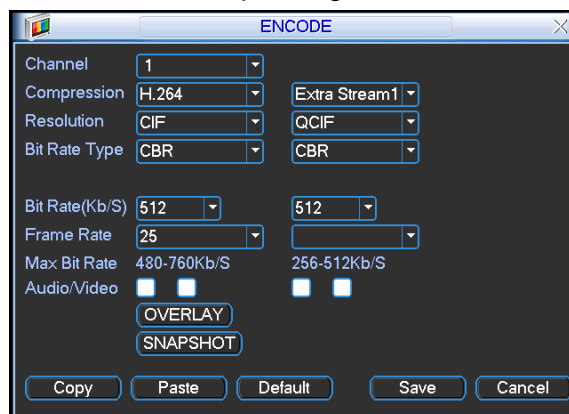

Figure 5-6

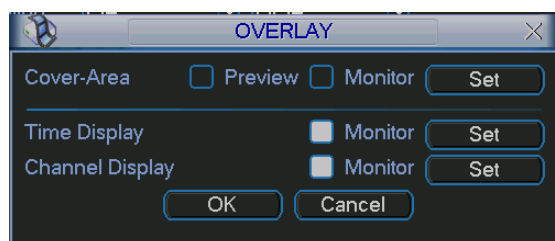

Figure 5-7

### 5.3.3 Schedule

Please refer to chapter 4.4 schedule.

### 5.3.4 RS232

RS232 interface is shown as below. There are five items. See Figure 5-8

- Function: There are various devices for you to select. Console is for serial port or min-end platform to upgrade program. Keyboard is for you to use special keyboard to control current device.
- Baud rate: You can select proper baud rate.
- Data bit: You can select proper data bit.
- Stop bit: There are three values: 1/1.5/2.
- Parity: there are three choices: none/odd/even.

System default setup is:

- Function: Console
- Baud rate:115200
- Data bit:8
- Stop bit:1
- Parity: None

After completing all the setups please click save button, system goes back to the previous menu.

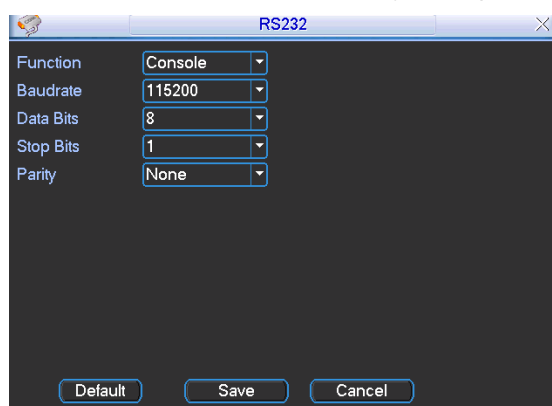

Figure 5-8

### 5.3.5 Network

Here is for you to input network information. See Figure 5-9.

- IP address: Here you can input IP address.
- DHCP: It is to auto search IP. When enable DHCP function, you can not modify IP/Subnet mask /Gateway. These values are from DHCP function. If you have not enabled DHCP function, IP/Subnet mask/Gateway display as zero. You need to disable DHCP function to view current IP information. Besides, when PPPoE is operating, you can not modify IP/Subnet mask /Gateway.
- TCP port: Default value is 37777.
- UDP port: Default value is 37778.
- HTTP port: Default value is 80.
- Max connection: system support maximal 10 users. 0 means there is no connection limit.
- Transfer mode: Here you can select the priority between fluency/video qualities.
- Network download: System can process the downloaded data first if you enable this function.

After completing all the setups please click save button, system goes back to the previous menu.

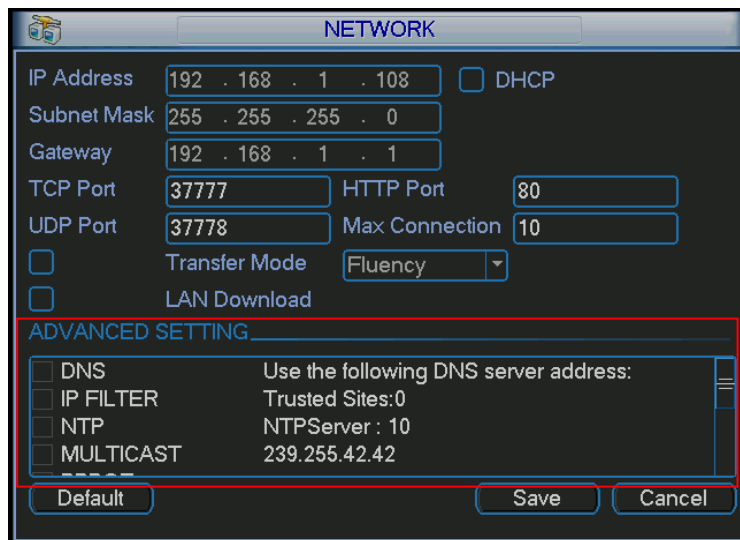

Figure 5-9

### 5.3.5.1 Advanced Setup

Advanced setup interface is shown as in Figure 5-10. Please draw a circle to enable corresponding function and then double click current item to go to setup interface.

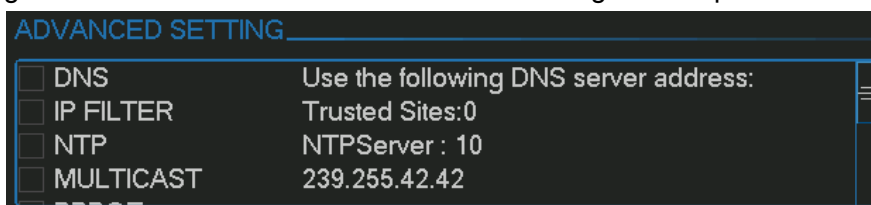

Figure 5-10

### 5.3.5.2 IP Filter

IP filter interface is shown as in Figure 5-11. You can add IP in the following list. The list supports max 64 IP addresses.

Please note after you enabled this function, only the IP listed below can access current DVR. If you disable this function, all IP addresses can access current DVR.



Figure 5-11

### 5.3.5.3 Multiple Cast Setup

Multiple-cast setup interface is shown as in Figure 5-12.

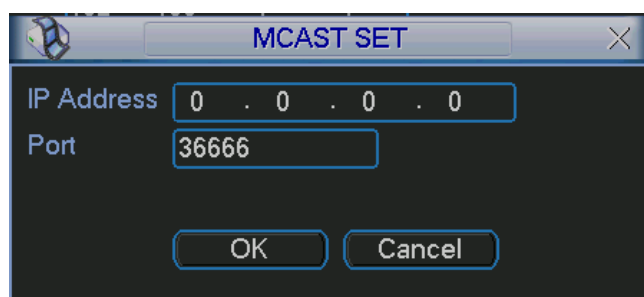

Figure 5-12

Here you can set a multiple cast group. Please refer to the following sheet for detailed information.

- IP multiple cast group address

-224.0.0.0-239.255.255.255

-“D” address space

- The higher four-bit of the first byte=“1110”

- Reserved local multiple cast group address

-224.0.0.0-224.0.0.255

-TTL=1 When sending out telegraph

-For example

224.0.0.1 All systems in the sub-net

224.0.0.2 All routers in the sub-net

224.0.0.4 DVMRP router

224.0.0.5 OSPF router

224.0.0.13 PIMv2 router

- Administrative scoped addressees

-239.0.0.0-239.255.255.255

-Private address space

- Like the single broadcast address of RFC1918
- Can not be used in Internet transmission
- Used for multiple cast broadcast in limited space.

Except the above mentioned addresses of special meaning, you can use other addresses. For example:

Multiple cast IP: 235.8.8.36

Multiple cast PORT: 3666.

After you logged in the Web, the Web can automatically get multiple cast address and add it to the multiple cast groups. You can enable real-time monitor function to view the view.

Please note multiple cast function applies to special classes only.

### 5.3.5.4 PPPoE

PPPoE interface is shown as in Figure 5-13.

Input “PPPoE name” and “PPPoE password” you get from your ISP (Internet service provider).

Click save button, you need to restart to activate your configuration.

After rebooting, DVR will connect to internet automatically. The IP in the PPPoE is the DVR dynamic value. You can access this IP to visit the unit.

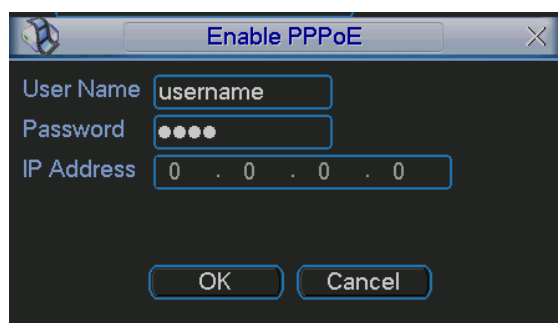

Figure 5-13

### 5.3.5.5 NTP Setup

You need to install SNTP server (Such as Absolute Time Server) in your PC first. In Windows XP OS, you can use command “net start w32time” to boot up NTP service.

NTP setup interface is shown as in Figure 5-14.

- Host IP: Input your PC address.
- Port: The Bronze Class IntelliPix supports TCP transmission only. Port default value is 123.
- Update interval: minimum value is 1. Max value is 65535. (Unit: minute)
- Time zone: select your corresponding time zone here.

Here is a sheet for your time zone setup.

City /Region Name	Time Zone
London	GMT+0
Berlin	GMT+1
Cairo	GMT+2
Moscow	GMT+3
New Deli	GMT+5
Bangkok	GMT+7
Beijing (Hong Kong)	GMT+8
Tokyo	GMT+9
Sydney	GMT+10
Hawaii	GMT-10
Alaska	GMT-9
Pacific Time(P.T)	GMT-8
American Mountain Time(M.T)	GMT-7
American Central Time(C.T)	GMT-6
American Eastern Time(E.T)	GMT-5
Atlantic Time	GMT-4
Brazil	GMT-3
Middle Atlantic Time	GMT-2

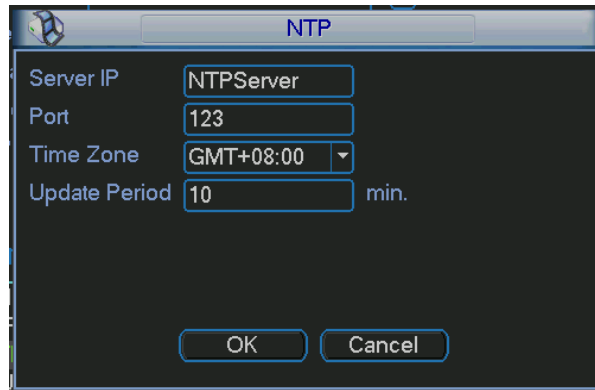

Figure 5-14

### 5.3.5.6 DDNS Setup

DDNS setup interface is shown as in Figure 5-15.

You need a PC of fixed IP in the internet and there is the DDNS software running in this PC. In other words, this PC is a DNS (domain name server).

In network DDNS, please select DDNS type and highlight enable item. Then please input your PPPoE name you get from you IPS and server IP (PC with DDNS ). Click save button and then reboot system.

Click save button, system prompts for rebooting to get all setup activated.

After rebooting, open IE and input as below:

http: //(DDNS server IP)/(virtual directory name)/webtest.htm

e.g.: http: //10.6.2.85/DVR\_DDNS/webtest.htm.)

Now you can open DDNSServer web search page.

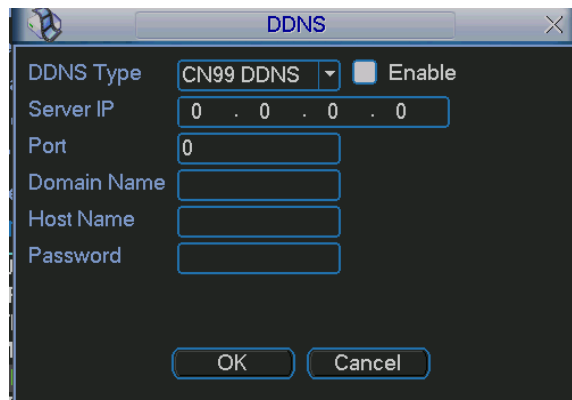

Figure 5-15

Please note NNDS type includes: CN99 DDNS、NO-IP DDNS、Private DDNS、Dyndns DDNS and sysdns DDNS. All the DDNS can be valid at the same time, you can select as you requirement.

Private DDNS function shall work with Dahua DDNS server and Dahua Professional Surveillance Software (PSS).

### 5.3.5.7 DNS

There are two modes: Manual setup and auto setup

- Manual Setup

You can double click DNS to set DNS address manually. See Figure 5-16.

Please input preferred DNS server IP and alternative DNS server IP.

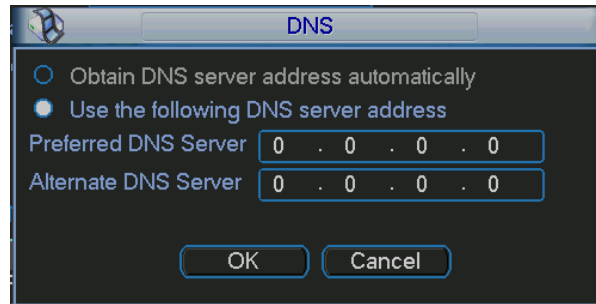

Figure 5-16

- Auto gets DNS address

Please enable DHCP function first and then double click DNS item.

If the DHCP function enabled successfully, system can get the DNS server IP address. See Figure 5-17.

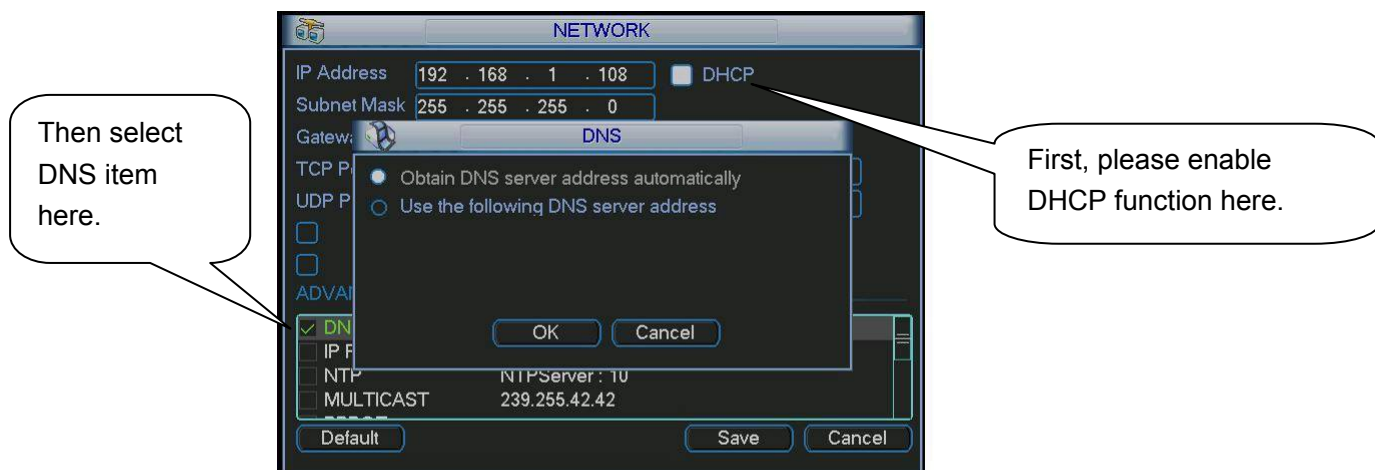

Figure 5-17

### 5.3.5.8 FTP

You need to download or buy FTP service tool (such as Ser-U FTP SERVER) to establish FTP service.

Please install Ser-U FTP SERVER first. From "start" -> "program" -> Serv-U FTP Server -> Serv-U Administrator. Now you can set user password and FTP folder. Please note you need to grant write right to FTP upload user. See Figure 5-18.



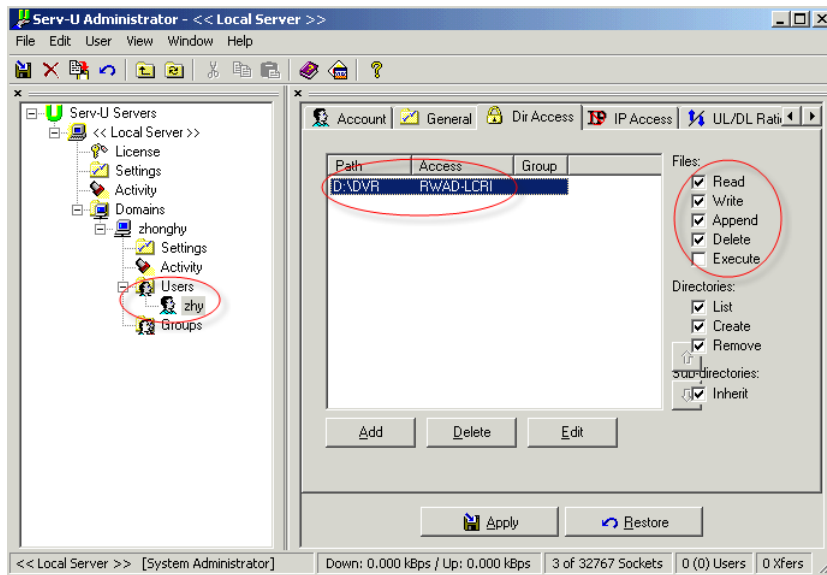

Figure 5-18

You can use a PC or FTP login tool to test setup is right or not.

For example, you can login user ZHY to [FTP://10.10.7.7](ftp://10.10.7.7) and then test it can modify or delete folder or not. See Figure 5-19.

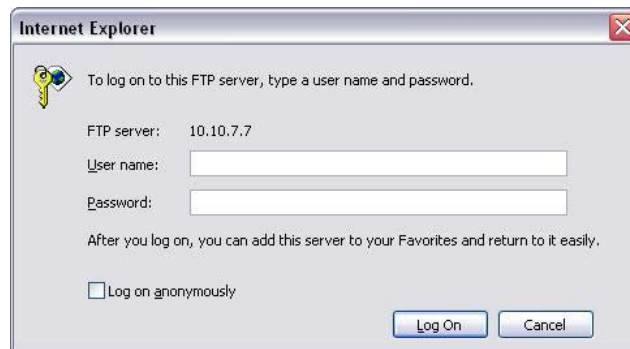

Figure 5-19

System also supports upload multiple DVRs to one FTP server. You can create multiple folders under this FTP.

In Figure 5-9, select FTP and then double click mouse. You can see the following interface. See Figure 5-20.

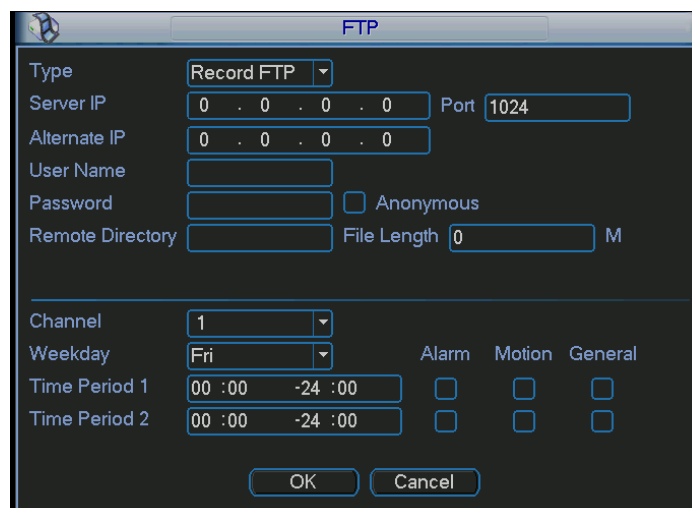

Figure 5-20

Please highlight the icon  in front of Enable to activate FTP function.

Here you can input FTP server address, port and remote directory. When remote directory is null, system automatically create folders according to the IP, time and channel.

User name and password is the account information for you to login the FTP.

File length is upload file length. When setup is larger than the actual file length, system will upload the whole file. When setup here is smaller than the actual file length, system only uploads the set length and auto ignore the left section. When interval value is 0, system uploads all corresponding files.

After channel and weekday setup, you can set two periods for one each channel.

### 5.3.6 Alarm

Please refer to chapter 4.6 Alarm Setup and Activation.

### 5.3.7 Detect

Please refer to chapter 4.5 Detect.

### 5.3.8 Pan/Tilt/Zoom

The pan/tilt/zoom setup includes the following items. Please select channel first. See Figure 5-21.

- Protocol: Select corresponding PTZ protocol such as PELCOD.
- Address: input corresponding PTZ address.
- Baud rate: Select baud rate.
- Data bit: Select data bit.
- Stop bit: Select stop bit.
- Parity: There are three choices: none/odd/even.

After completing all the setups please click save button, system goes back to the previous menu.



For detailed setup, please refer to chapter 4.9 preset/patrol/pattern/scan.



Figure 5-21

### 5.3.9 Display

Display setup interface is shown as below. See Figure 5-22.

- Transparency: Here is for you to adjust transparency. The value ranges from 128 to 255.
- Channel name: Here is for you to modify channel name. System max support 25-digit (The value may vary due to different classes). Please note all your modification here only applies to DVR local end. You need to open web or client end to refresh channel name.
- Time display: You can select to display time or not when system is playback.
- Channel display: You can select to channel name or not when system is playback.
- Overlay information: System displays some information in the screen for your reference.
- Display mode: you can select from the dropdown list: self-adaptive/VGA/TV.
- Enable tour: activate tour function.
- Interval: Input proper interval value here. The value ranges from 5-120 seconds. In tour process, you can use mouse or click Shift to turn on window switch function.  Stands for opening switch function,  stands for closing switch function.
- Motion tour type: System support 1/8 window tour.
- Alarm tour type: System support 1/4/9/16 window tour.

Please highlight icon  to select the corresponding function.

After completing all the setups please click save button, system goes back to the previous menu.

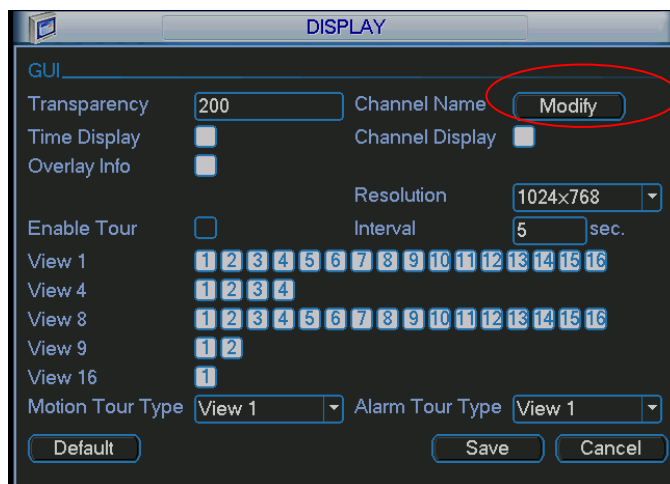

Figure 5-22

In Figure 5-22, click modify button after channel. You can see an interface is shown as in Figure 5-23. Please note all your modification here applies to local end only. You need to refresh web or client-end to get the latest channel name. System max support 25-digital character.

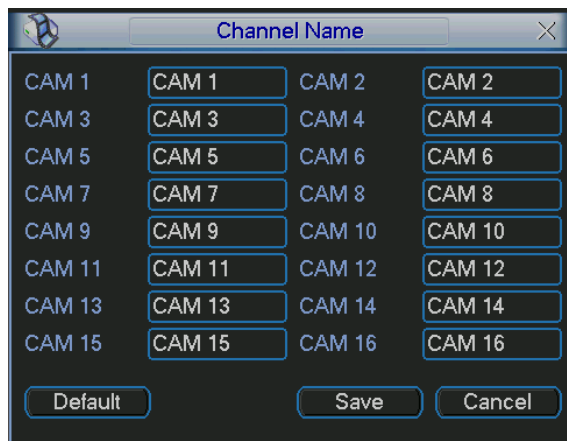



Figure 5-23

In tour mode, you can see the following interface. On the right corner, right click mouse or click shift button, you can control the tour. There are two icons:  stands for enabling window switch and  stands for enabling window function. See Figure 5-24.

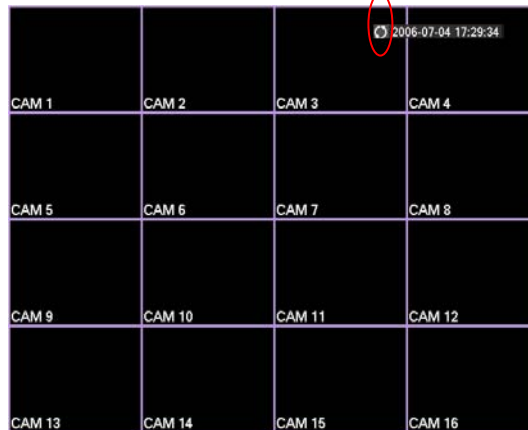



Figure 5-24

### 5.3.10 Default

Click default icon, system pops up a dialogue box. You can highlight  to restore default factory setup. See Figure 5-25.

- Select all
- General
- Encode
- Schedule
- RS232
- Network
- Alarm
- Detect
- Pan/tilt/zoom
- Display
- Channel name

Please highlight icon  to select the corresponding function.

After all the setups please click save button, system goes back to the previous menu.

#### **Warning!**

System menu color, language, time display mode, video format, IP address, user account will not maintain previous setup after default operation!

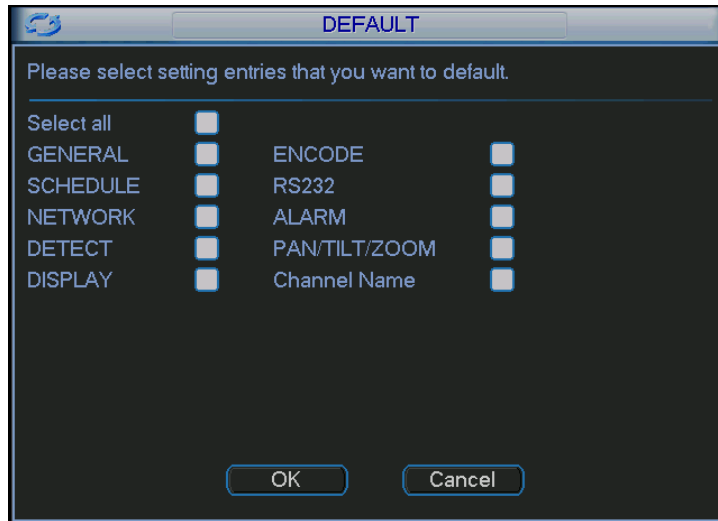

Figure 5-25

## 5.4 Search

Please refer to chapter 4.3 Search.

## 5.5 Advanced

Double click advanced icon in the main window, the interface is shown as below. See Figure 5-26. There are total seven function keys: HDD management, alarm output, abnormality, manual record, account, auto maintenance, and TV adjust.



Figure 5-26

### 5.5.1 HDD Management

Here is for you to view and implement hard disk management. See Figure 5-27.

You can see current HDD type, status, capacity and record time.

You can select HDD mode from the dropdown list such as read-only or you can erase all data in the HDD.

Please note system needs to reboot to get all the modification activated.

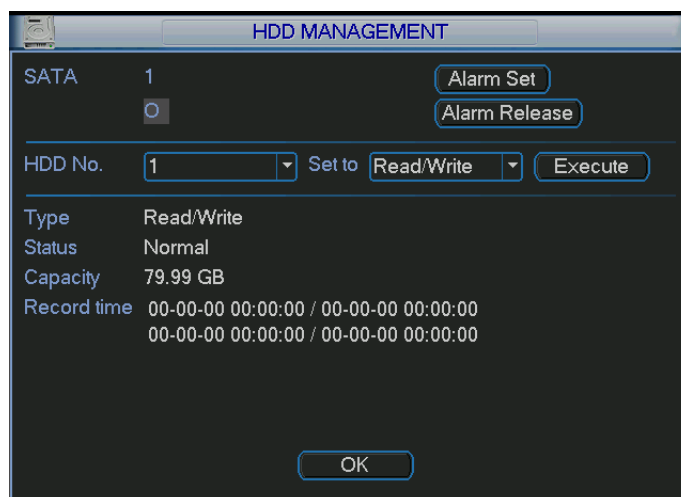

Figure 5-27

Click alarm set button, the interface is shown as below. See Figure 5-28(This interface is just like the abnormality setup). Please refer to chapter 5.5.2 for detail information.

Please highlight icon  to select the corresponding function.

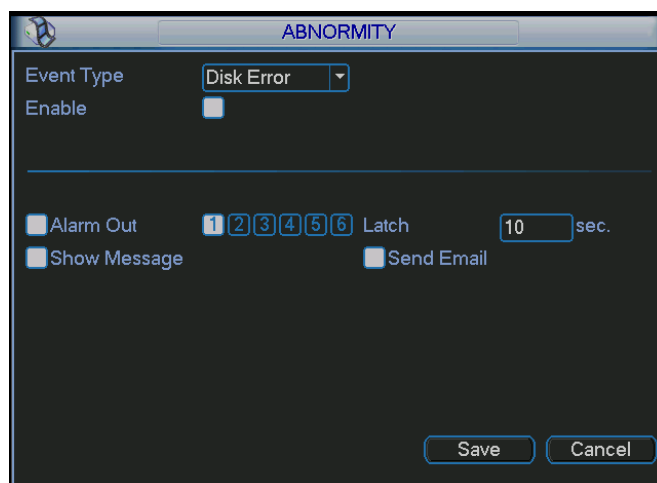

Figure 5-28

### 5.5.2 Abnormity

Abnormity interface is shown as in Figure 5-29.

- Event type: There are several options for you such as disk error, no disk and etc.
- Alarm output: alarm activation output port (multiple choices). The 3-ch is controllable 12V output.
- Latch: here you can set corresponding delaying time. The value ranges from 10s-300s. System automatically delays specified seconds in turning off alarm and activated output after external alarm cancelled.
- Show message: system can pop up the message in the local screen to alert you when alarm occurs.
- Send email: System can send out email to alert you when alarm occurs.

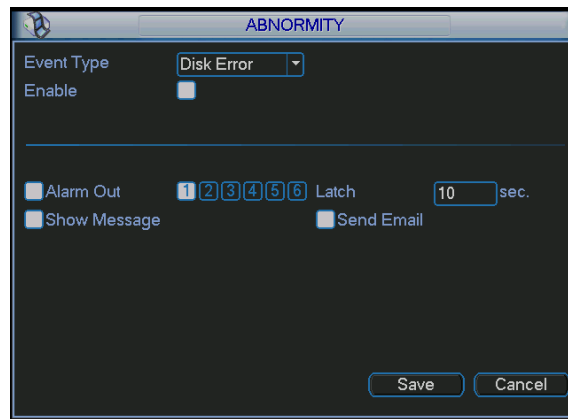



Figure 5-29

### 5.5.3 Alarm Output

Here is for you to set proper alarm output.

Please highlight icon  to select the corresponding alarm output.

After all the setups please click OK button, system goes back to the previous menu. See Figure 5-30.

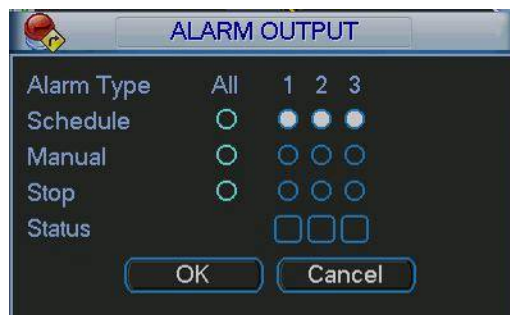

Figure 5-30

### 5.5.4 Manual Record

Please refer to chapter 4.2.2 manual record.

### 5.5.5 Account

Here is for you to implement account management. See Figure 5-31. Here you can:

- Add new user
- Modify user
- Add group
- Modify group
- Modify password.

For account management please note:

- System account adopts two-level management: group and user. No limit to group or user amount.
- For group or user management, there are two levels: admin and user.

- The user name and group name can consist of eight bytes. One name can only be used once. There are four default users: admin/888888/666666 and hidden user “default”. Except user 6666, other users have administrator right.
  - Hidden user “default” is for system interior use only and can not be deleted. When there is no login user, hidden user “default” automatically login. You can set some rights such as monitor for this user so that you can view some channel view without login.
  - One user should belong to one group. User right can not exceed group right.
  - About reusable function: this function allows multiple users use the same account to login.
- After all the setups please click save button, system goes back to the previous menu.

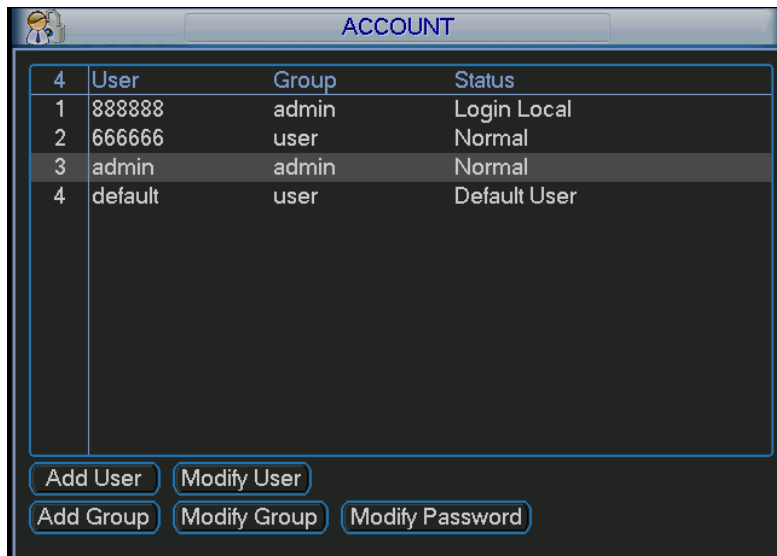

Figure 5-31

### 5.5.6 Auto Maintain

Here you can set auto-reboot time and auto-delete old files setup. See Figure 5-32.

You can select proper setup from dropdown list.

After all the setups please click save button, system goes back to the previous menu.

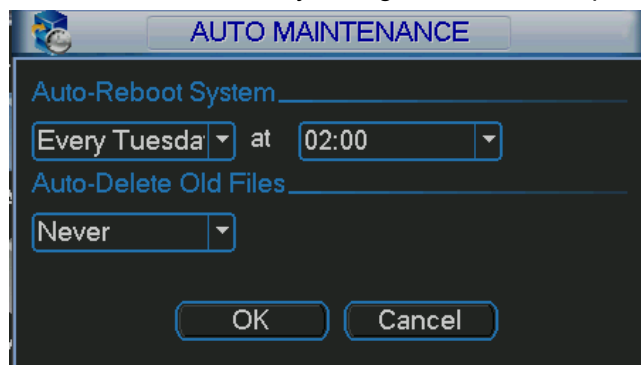

Figure 5-32

### 5.5.7 TV Adjust

Here is for you to adjust TV output setup. See Figure 5-33.

Please drag slide bar to adjust each item.



After all the setups please click OK button, system goes back to the previous menu.



Figure 5-33

## 5.6 Information

Here is for you to view system information. There are total five items: HDD (hard disk information), BPS (data stream statistics), Log and version, and online user. See Figure 5-34.

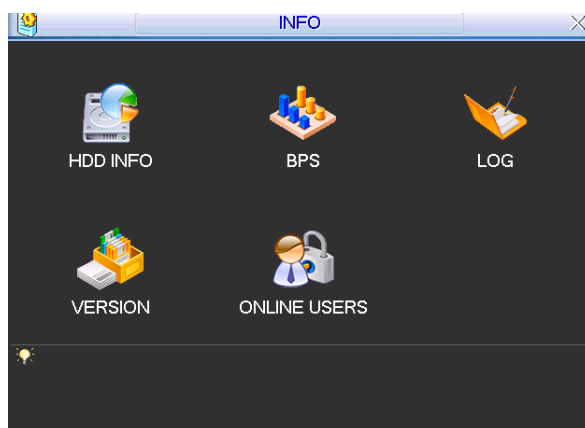

Figure 5-34

### 5.6.1 HDD Information

Here is to list hard disk type, total space, free space, video start time and status. See Figure 5-35. ○ means current HDD is normal. X means there is error. - means there is no HDD.

If disk is damaged, system shows as “?”. Please remove the broken hard disk before you add a new one.

Once there is a hard disk confliction, please check hard disk time and system time is the same or not. Please go to setting then general to modify system time. At last, reboot the system to solve this problem.

After system booted up, if there is any confliction, system goes to HDD information interface directly. Please note, system does not ask you to deal with it forcedly.

When HDD confliction occurs, you can check system time and HDD time are identical or not. If they are not identical, please go to General (Chapter 5.3.1) to adjust system time or go to HDD Management (Chapter 5.5.1) to format HDD and then reboot the DVR.

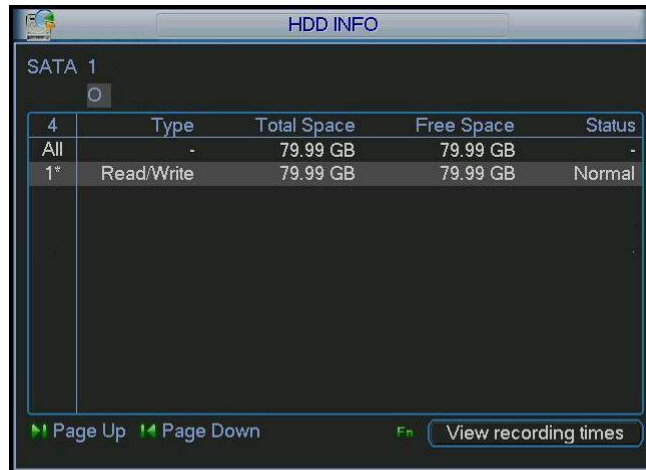

Figure 5-35

Tips:

Please click Fn button or left click mouse to view HDD record time and HDD type and time.

### 5.6.2 BPS

Here is for you to view current video data stream (KB/s) and occupied hard disk storage (MB/h).

See Figure 5-36.

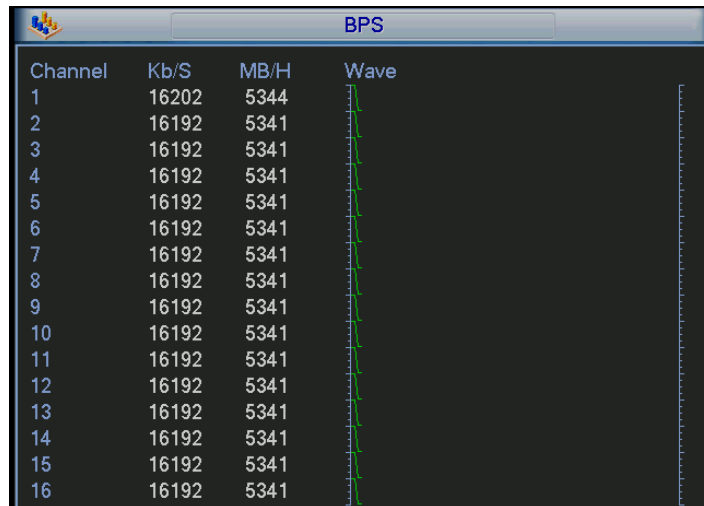

Figure 5-36

### 5.6.3 Log

Here is for you to view system log file. System lists the following information. See Figure 5-37.

Log types include system operation, configuration operation, data management, alarm event, record operation, log clear and etc.

Please select start time and end time, then click search button. You can view the log files.

Please page up/down button to view if there are more than ten files.

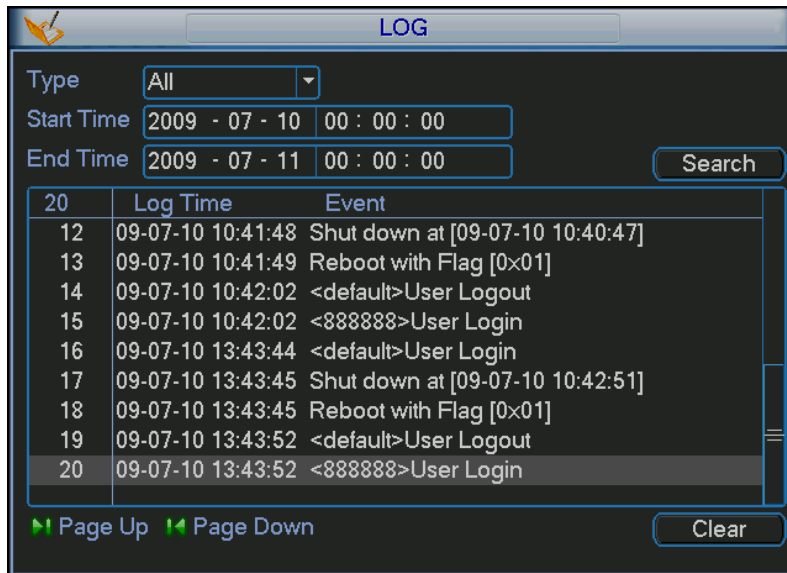

Figure 5-37

### 5.6.4 Version

Here is for you to view some version information. See Figure 5-38.

- Channel
- Alarm in
- Alarm out
- System version:
- Build Date

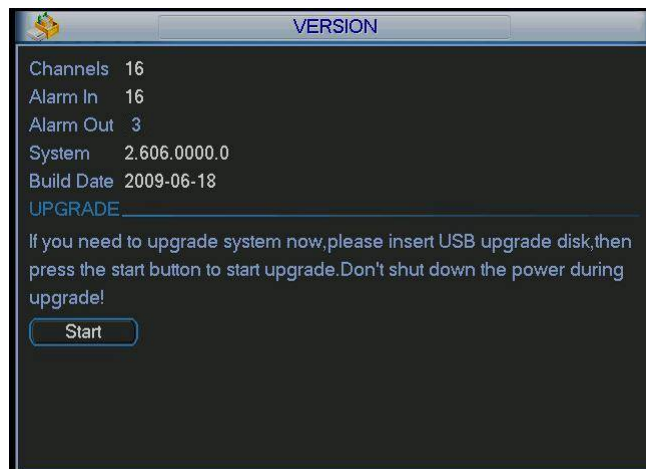

Figure 5-38

### 5.6.5 Online Users

Here is for you manage online users. See Figure 5-39.

You can disconnect one user or block one user if you have proper system right. Max disconnection setup is 65535 seconds.

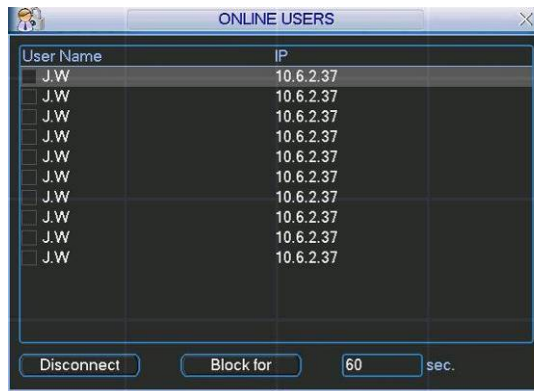

Figure 5-39

## 5.7 Shutdown

Double click shutdown button, system pops up a dialogue box for you to select. See Figure 5-40.

- Logout menu user: log out menu. You need to input password when you login the next time.
- Restart application: reboot DVR.
- Shutdown: system shuts down and turns off power.
- Restart system: system begins rebooting.
- Switch user: you can use another account to log in.

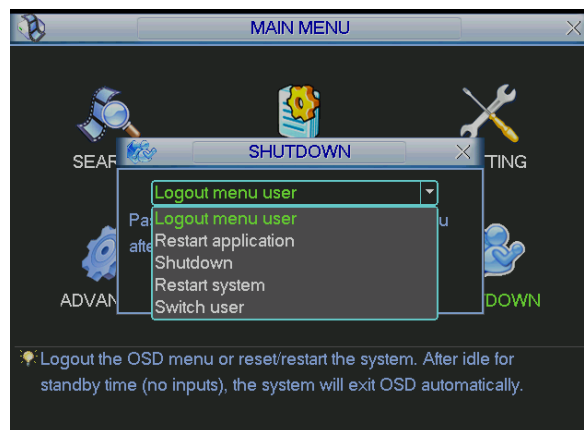

Figure 5-40

## 6 About Auxiliary Menu

### 6.1 Go to Pan/Tilt/Zoom Menu

In the one-window surveillance mode, right click mouse (click “fn” Button in the front panel or click AUX key in the remote control). The interface is shown as below: See Figure 6-1.



Figure 6-1

Click Pan/Tilt/Zoom, the interface is shown as in Figure 6-2.

Here you can set the following items:

- Zoom
- Focus
- Iris

Please click icon  and  to adjust zoom, focus and Iris.



Figure 6-2

In Figure 6-2, please click direction arrows (See Figure 6-3 ) to adjust PTZ position. There are totally eight direction arrows. (Please note there are only four direction arrows in DVR front panel.)



Figure 6-3

#### 6.1.1 3D Intelligent Positioning Key

In the middle of the eight direction arrows, there is a 3D intelligent positioning key. See Figure 6-4 . Please make sure your protocol supports this function and you need to use mouse to control.

Click this button, system goes back to the single screen mode. Drag the mouse in the screen to adjust section size.



Figure 6-4

Here is a sheet for you reference.

Name	Function key	function	Shortcut key	Function key	function	Shortcut key
Zoom		Near			Far	
Focus		Near			Far	
Iris		close			Open	

## 6.2 Preset /Patrol / Pattern /Border Function

In Figure 6-2 click the set button. The interface is shown as below:

Here you can set the following items:

- Preset
- Patrol
- Pattern
- Border



Figure 6-5

In Figure 6-2, click page switch button, you can see an interface as in Figure 6-6.

Here you can activate the following functions:

- Preset
- Tour(Patrol)
- Pattern
- Auto scan
- Auto pan
- Flip
- Page Switch

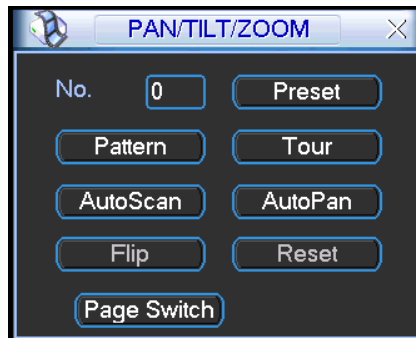

Figure 6-6

### 6.2.1 Preset Setup

**Note:** The following setups are usually operated in the Figure 6-2, Figure 6-5 and Figure 6-6. In Figure 6-2, use eight direction arrows to adjust camera to the proper position. In Figure 6-5, click preset button and input preset number. The interface is shown as in Figure 6-7.

Add this preset to one patrol number



Figure 6-7

### 6.2.2 Activate Preset

In Figure 6-6 please input preset number in the No. blank, and click preset button.

### 6.2.3 Patrol Setup

In Figure 6-5, click patrol button. The interface is shown as in Figure 6-8.

Input preset number and then add this preset to one patrol.



Figure 6-8

### 6.2.4 Activate Patrol

In Figure 6-6, input patrol number in the No. blank and click patrol button

### 6.2.5 Pattern Setup

In Figure 6-5, click pattern button and then click begin button. The interface shows like Figure 6-9. Please go to Figure 6-2 to modify zoom, focus, and iris. Go back to Figure 6-9 and click end button.

You can memorize all these setups as pattern 1.



Figure 6-9

### 6.2.6 Activate Pattern Function

In Figure 6-6 input mode value in the No. blank, and click pattern button.

### 6.2.7 Border Setup

In Figure 6-5, click border button. The interface is shown as in Figure 6-10.

Please go to Figure 6-2, use direction arrows to select camera left limit, and then please go to Figure 6-10 and click left limit button

Repeat the above procedures to set right limit.



Figure 6-10

### 6.2.8 Activate Border Function

In Figure 6-6, click auto scan button, the system begins auto scan. Correspondingly, the auto scan button changes to stop button.

Click stop button to terminate scan operation.

### 6.2.9 Flip

In Figure 6-6, click page switch button, you can see an interface is shown as below. See Figure 6-11. Here you can set auxiliary function.

Click page switch button again, system goes back to Figure 6-2.



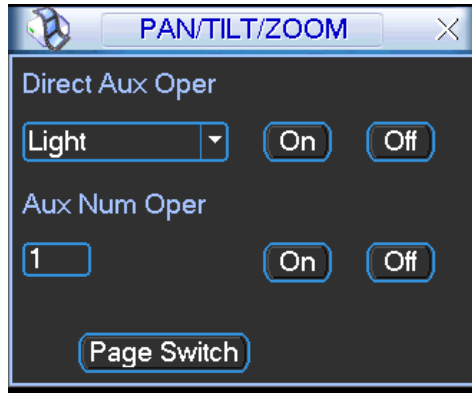

Figure 6-11

## 7 WEB CLIENT OPERATION

Please note all the operations here are based on our 4-ch DVR.  
There might be slightly difference in the interface due to different classes.

### 7.1 Network Connection

Before web client operation, please check the following items:

- Network connection is right
- DVR and PC network setup is right. Please refer to network setup(main menu->setting->network)
- Use order ping `***.***.***.***`(\* DVR IP address) to check connection is OK or not. Usually the return TTL value should be less than 255.
- Open the IE and then input DVR IP address.
- System can automatically download latest web control and the new version can overwrite the previous one.
- If you want to un-install the web control, please run `uninstall webrec2.0.bat`. Or you can go to `C:\Program Files\webrec` to remove single folder. Please note, before you un-install, please close all web pages, otherwise the un-installation might result in error.

### 7.2 Login

Open IE and input DVR address in the address column. For example, if your DVR IP is 10.10.3.16, then please input `http:// 10.10.3.16` in IE address column. See Figure 7-1

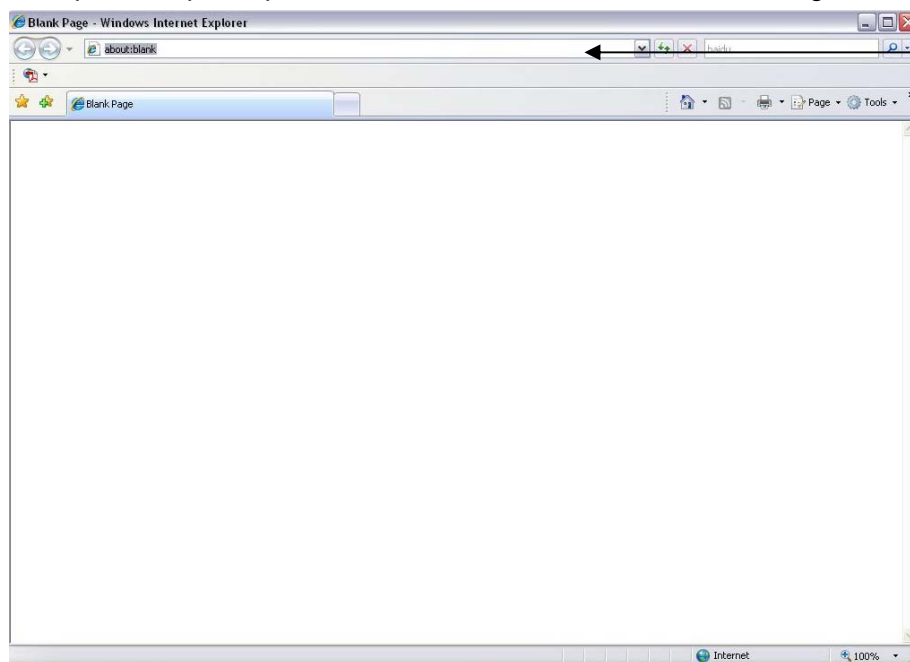

Figure 7-1

System pops up warning information to ask you whether install webrec.cab control or not. Please click yes button.

If you can't download the ActiveX file, please modify your settings as follows. See Figure 7-2.

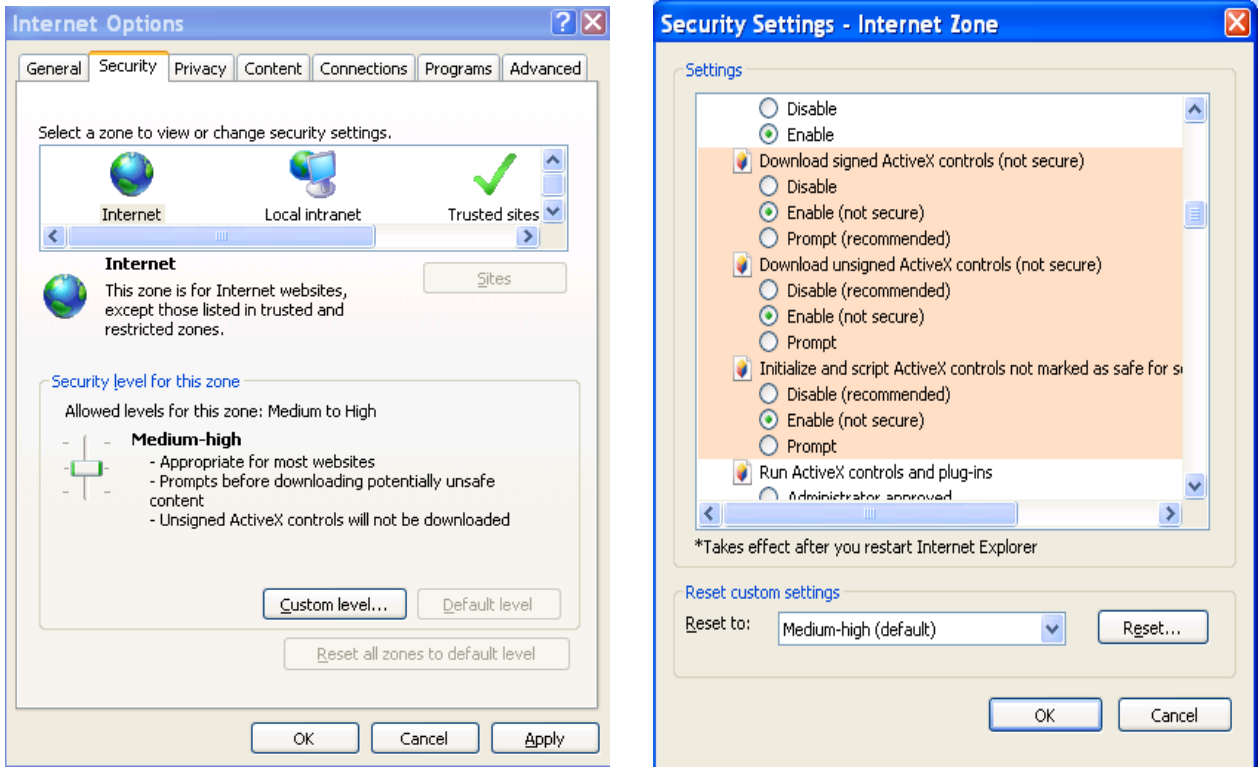

Figure 7-2

After installation, the interface is shown as below. See Figure 7-3.

Please input your user name and password.

Default factory name is admin and password is admin.

**Note:** For security reasons, please modify your password after you first login.

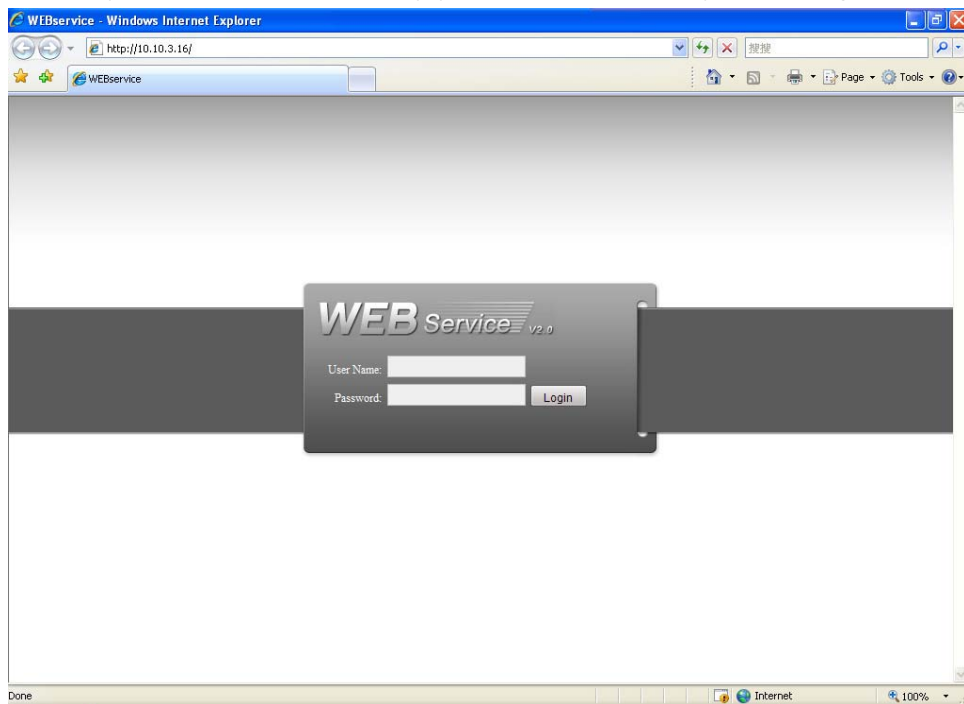

Figure 7-3

After you logged in, you can see the main window. See Figure 7-6.

This main window can be divided into the following sections.

- Section 1: there are five function buttons: configuration (chapter 7.3), search (chapter 7.4), alarm (chapter 7.5), about (chapter 7.6), log out (chapter 7.7).
- Section 2: there are channel number and three function buttons: start dialog and local play, refresh.
- Section3: there are PTZ (chapter 7.2.2), color (chapter 7.2.3) button and you can also select picture path and record path.
- Section 4:real-time monitor window. Please note current preview window is circled by a green rectangle zone.
- Section 5: Here you can view window switch button. You can also select video priority between fluency or real-time.
  - ✧ System monitor window switch supports full screen/1-window/4-window/6-window/8-window/9-window/13-window/16-window/20-window/25-window/36-window. See Figure 7-4.



Figure 7-4

- ✧ Preview window switch. System support 1/4/8/9/16-window real-time preview. Please you need to have the proper rights to implement preview operation. You can not preview if you have no right to preview the either channel. See Figure 7-5.



Figure 7-5



Figure 7-6

### 7.2.1 Real-time Monitor

In section 2, left click the channel name you want to view, you can see the corresponding video in current window.

On the top left corner, you can view device IP, channel number, network monitor bit stream.

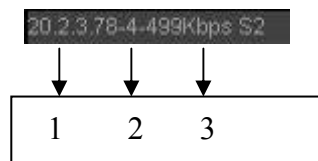

Figure 7-7

On the top right corner, there are six function buttons. See Figure 7-8.

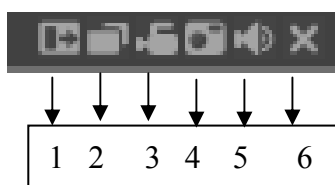

Figure 7-8

- 1: Digital zoom: Click this button and then left drag the mouse in the zone to zoom in. right click mouse system restores original status.
- 2: Change show mode: resize or switch to full screen mode.
- 3: Local record. When you click local record button, the system begins recording and this button becomes highlighted. You can go to system folder RecordDownload to view the recorded file.
- 4: Capture picture. You can snapshot important video. All images are memorized in system client folder \download\picture (default).
- 5: Audio :Turn on or off audio.(It has no relationship with system audio setup )
- 6: Close video.

Please refer to Figure 7-9 for main stream and extra stream switch information.



Figure 7-9

### Open All

You can click it to open all channels.

### Refresh

You can use button to refresh camera list.

### Start Dialogue

You can click this button to enable audio talk.

### Local Play

Click local play button, system pops up the following interface for you to select local play file. See Figure 7-10.



Figure 7-10

### 7.2.2 PTZ

Before PTZ operation, please make sure you have properly set PTZ protocol. (Please refer to chapter 7.3.2 Setting-> Pan/Tilt/Zoom).

Click PTZ button, the interface is shown as in Figure 7-11 .

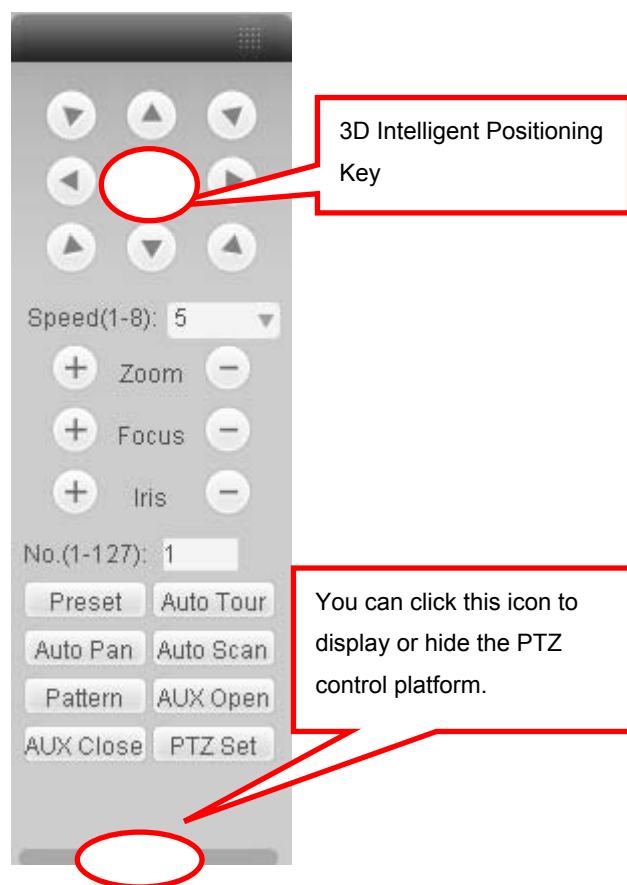

Figure 7-11

### 7.2.2.1 Direction key and 3D positioning key

In Figure 7-10, there are eight direction keys.

In the middle of the eight direction keys, there is a 3D intelligent positioning key.

Click 3D intelligent positioning key, system goes back to the single screen mode. Drag the mouse in the screen to adjust section size. It can realize PTZ automatically.

### 7.2.2.2 Speed

System supports eight-level speed. You can select from the dropdown list. Speed 2 is faster than speed 1.

### 7.2.2.3 Zoom/Focus/Iris

Here is a sheet for you reference.

Name	Function key	Function	Function key	Function
Zoom		Near		Far
Focus		Near		Far
Iris		close		Open

In Figure 7-11, click PTZ setup button you can see the following interface. See Figure 7-12.

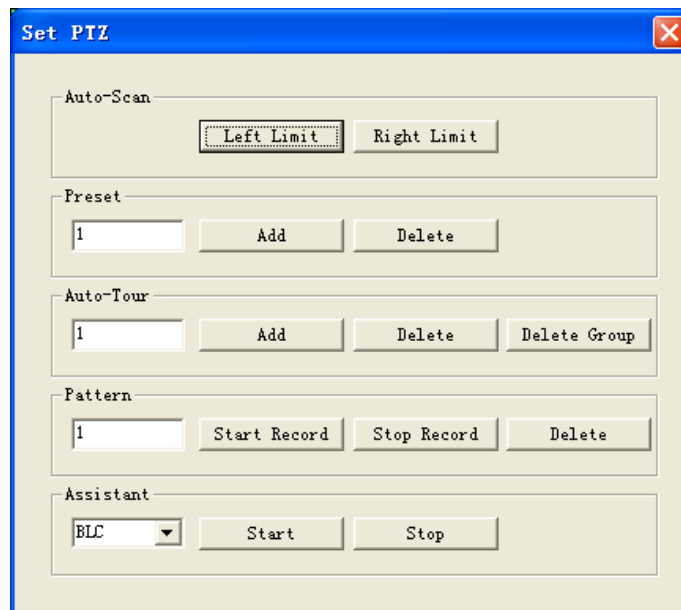

Figure 7-12

#### 7.2.2.4 Auto Scan

In Figure 7-12, move the camera to your desired location and then click left limit button. Then move the camera again and then click right limit button to set a right limit.

#### 7.2.2.5 Pattern

In Figure 7-12, you can input pattern value and then click start record button to begin PTZ movement. Please go back to Figure 7-11 to implement camera operation. Then you can click stop record button. Now you have set one pattern.

#### 7.2.2.6 Preset

In Figure 7-12, move the camera to your desired location and then input preset value. Click add button, you have set one preset.

#### 7.2.2.7 Auto tour

In Figure 7-12, input auto tour value and preset value. Click add button, you have added one preset in the tour.

Repeat the above procedures you can add more presets in one tour.

#### 7.2.2.8 Assistant

You can select the assistant item from the dropdown list. See Figure 7-13.



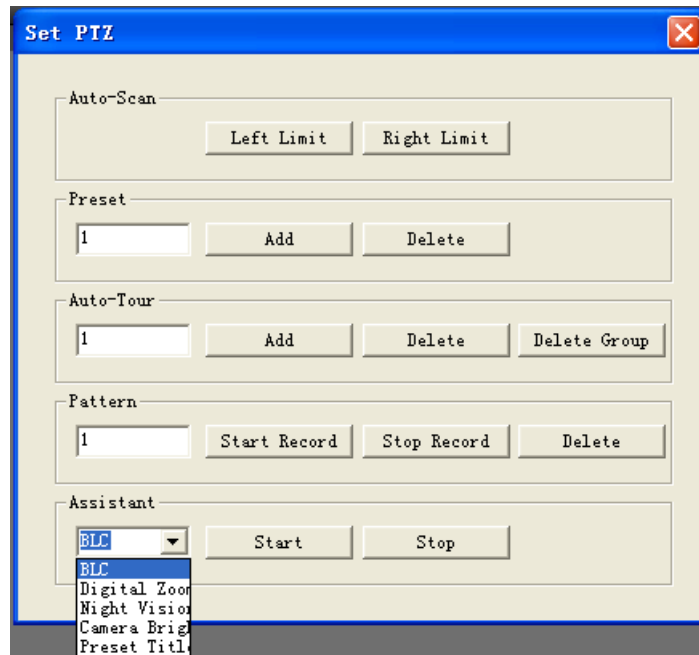

Figure 7-13

### 7.2.3 Color

Click color button in section 3, the interface is shown as Figure 7-14.

Here you can select one channel and then adjust its brightness, contrast, hue and saturation. (Current channel border becomes green).

Or you can click default button to use system default setup.

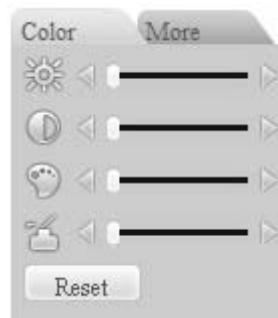

Figure 7-14

### 7.2.4 Picture Path and Record Path

Click more button in Figure 7-14, you can see an interface is shown as in Figure 7-15.

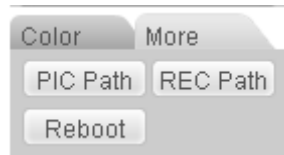

Figure 7-15

Click picture path button, you can see an interface is shown as in Figure 7-16.

Please click choose button to modify path.

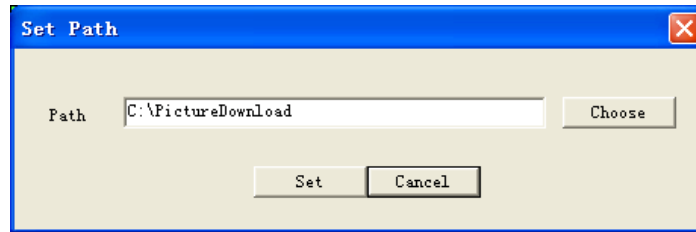

Figure 7-16

Click record path button, you can see an interface is shown as in Figure 7-17. Please click choose button to modify path.

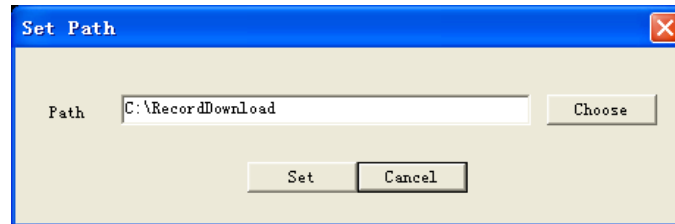

Figure 7-17

Click reboot button, system pops up the following dialogue box. See Figure 7-18, Please click OK to reboot.

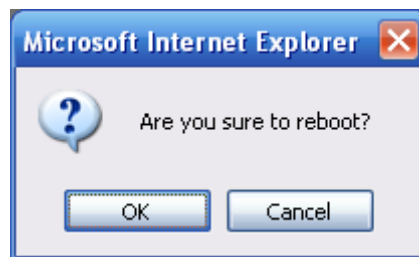

Figure 7-18

## 7.3 Configure

### 7.3.1 System Information

#### 7.3.1.1 Version Information

Here you can view device hardware feature and software version information. See Figure 7-19.

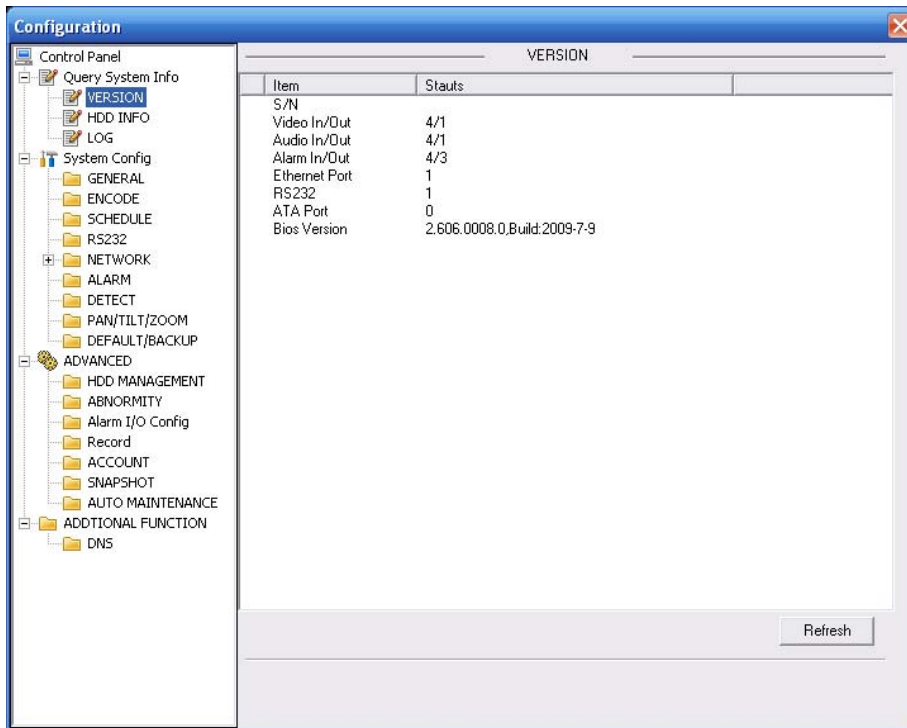

Figure 7-19

### 7.3.1.2 HDD information

Here you can view local storage status and network status including, free capacity and total capacity. See Figure 7-20.

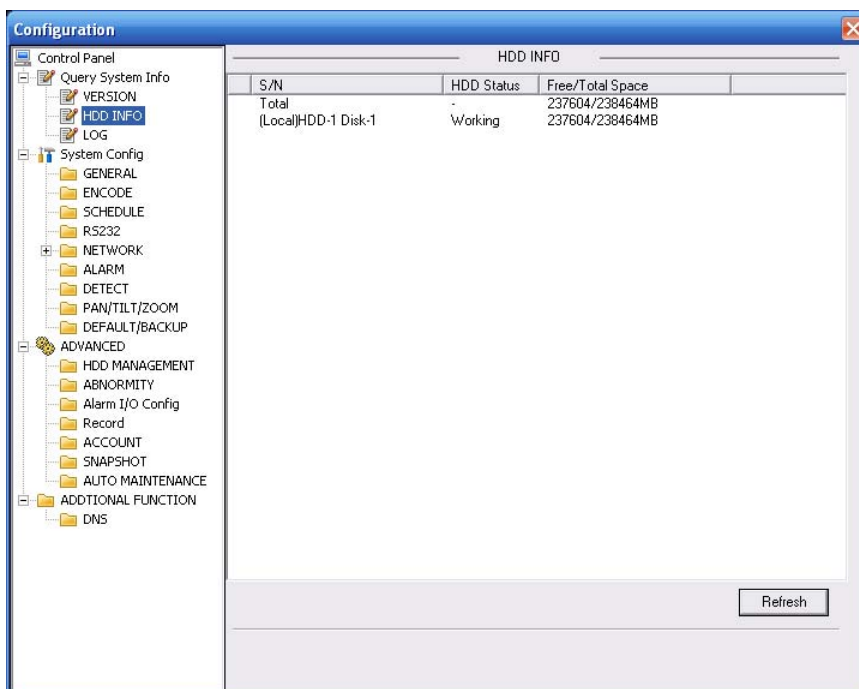

Figure 7-20

### 7.3.1.3 Log

Here you can view system log. See Figure 7-21.

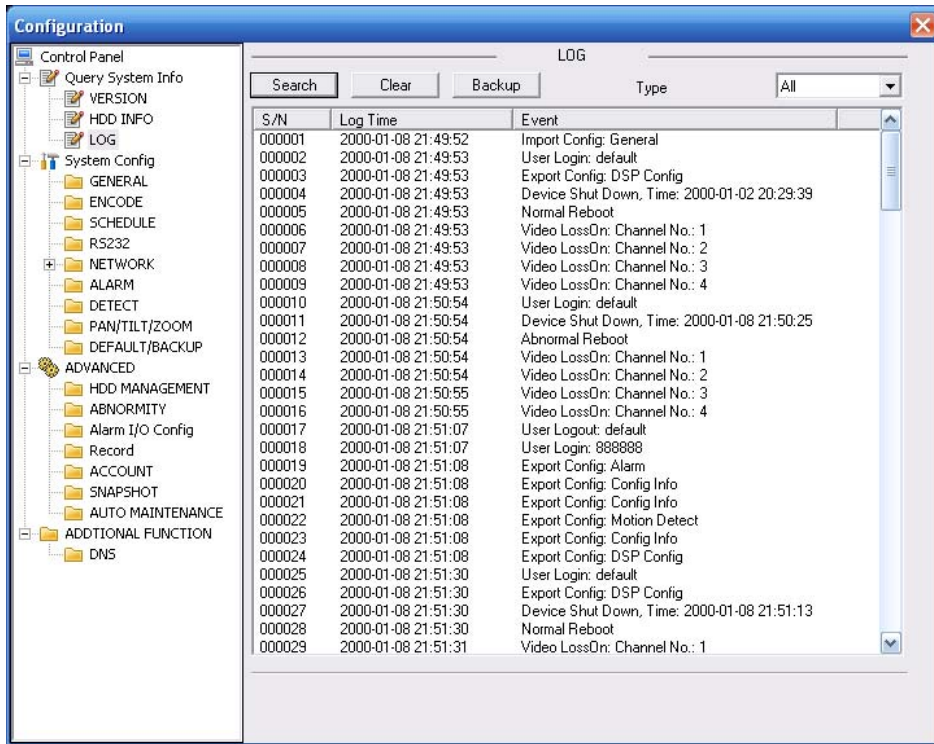

Figure 7-21

Click backup button, the interface is shown as in Figure 7-22.

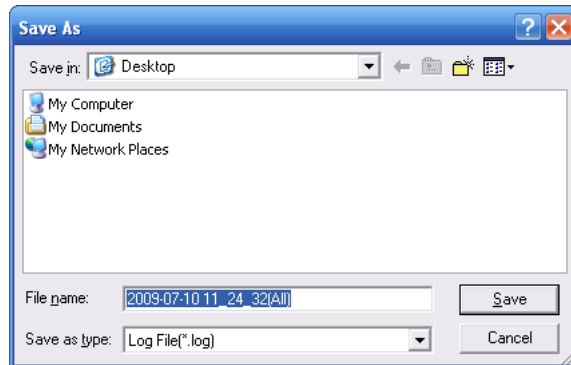

Figure 7-22

Please refer to the following sheet for log parameter information.

Parameter	Function
Type	Log types include: system operation, configuration operation, data management, alarm event, record operation, user management, log clear and file operation.
Search	You can select log type from the drop down list and then click search button to view the list.
Clear	You can click this button to delete all displayed log files. Please note system does not support clear by type.
Backup	You can click this button to backup log files to current PC.

### 7.3.2 System Configuration

Please click save button to save your current setup.

#### 7.3.2.1 General Setup

Here you can set system time, record length, video format and etc. See Figure 7-23.

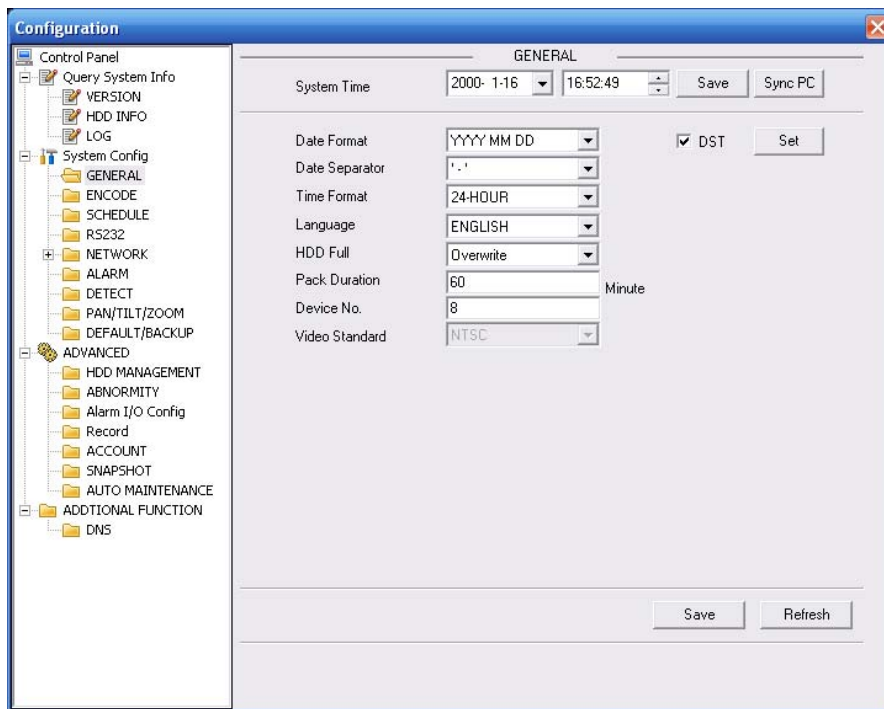

Figure 7-23

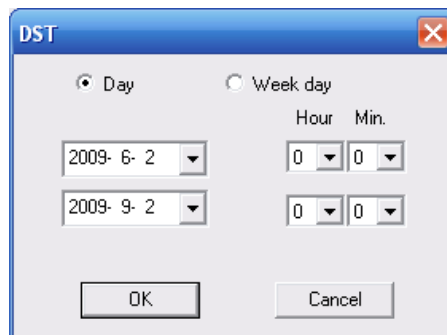

Figure 7-24

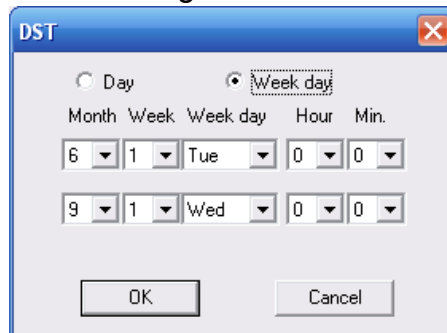

Figure 7-25

Please refer to the following sheet for detailed information.

Parameter	Function
System Time	Here is for you to modify system time. Please click Save button after your completed modification
Sync PC	You can click this button to save the system time as your PC current time.

Data Format	Here you can select data format from the dropdown list.
Data Separator	Please select separator such as – or /.
Time Format	There are two options: 24-H and 12-H.
DST	Here you can set day night save time begin time and end time. See Figure 7-24 and Figure 7-25.
Language	You can select the language from the dropdown list. Device needs to reboot to get the modification activated.
HDD Full	There are two options: stop recording or overwrite the previous files when HDD is full.
Pack Duration	Here you can select file size. Default setup is 60 minutes.
Device No	When you are using one remote control (not included in the accessory bag) to manage multiple devices, you can give a serial numbers to the device.
Video Standard	There are two options: PAL.

### 7.3.2.2 Encode

Encode interface is shown as in Figure 7-26.

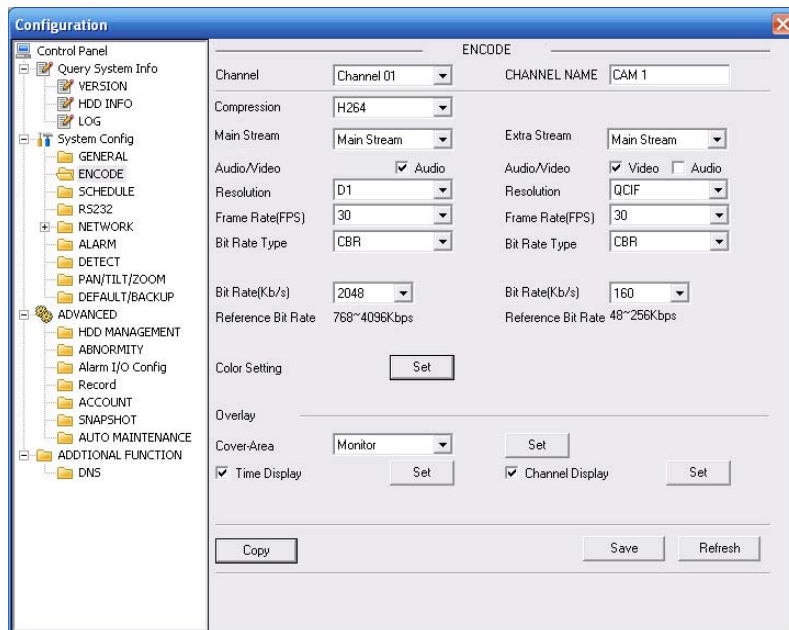

Figure 7-26

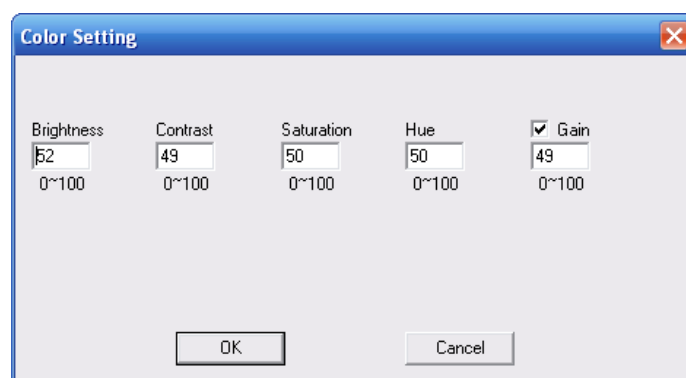

Figure 7-27

Please refer to the following sheet for detailed information.

Parameter	Function
Channel	Here is for you to select a monitor channel.
Channel Name	Here is to display current channel name. You can modify it.
Compression	H.264
Main Stream	<p>It includes main stream, motion stream and alarm stream. You can select different encode frame rates form different recorded events.</p> <p>System supports active control frame function (ACF). It allows you to record in different frame rates.</p> <p>For example, you can use high frame rate to record important events, record scheduled event in lower frame rate and it allows you to set different frame rates for motion detection record and alarm record.</p>
Extra Stream	Select extra stream if you enabled the extension stream to monitor.
Audio/Video	Recorded file only contains video by default. You need to draw a circle here to enable audio function.
Resolution	<p>For 16ch series:</p> <p>Main stream of channel 1 and channel 9 support D1/CIF/QCIF.</p> <p>Main stream of channel 2 to 8 and channel 10 to 16 support CIF only.</p> <p>Extra stream of channel 1 to channel 16 support QCIF only.</p>
Frame Rate	PAL: 1~25f/s; NTSC: 1~30f/s
Bit Rate Type	There are two options: VBR and CBR. Please note, you can set video quality in VBR mode only.
Quality	The value ranges from 1 to 6. The level 6 is the best video quality.
Bit Rate	<ul style="list-style-type: none"> <li>• In CBR, the bit rate here is the max value. In dynamic video, system needs to low frame rate or video quality to guarantee the value.</li> <li>• The value is null in VBR mode.</li> <li>• Please refer to recommend bit rate for the detailed information.</li> </ul>

Parameter	Function
Recommended Bit	Recommended bit rate value according to the resolution and frame rate you have set.
Color Setting	Here you can set video brightness, contrast ness, hue, saturation and gain. The value ranges from 0 to 100.Default value is 50. See Figure 7-27.
Cover area (privacy mask)	<ul style="list-style-type: none"> <li>Here you can privacy mask the specified video in the monitor video.</li> <li>System max supports 8 privacy mask zones.</li> </ul>
Time Title	<ul style="list-style-type: none"> <li>You can enable this function so that system overlays time information in video window.</li> <li>OSD transparent value ranges from 0 to 255. 0 means complete transparent.</li> <li>You can use the mouse to drag the time tile position.</li> </ul>
Channel Title	<ul style="list-style-type: none"> <li>You can enable this function so that system overlays channel information in video window.</li> <li>OSD transparent value ranges from 0 to 255. 0 means complete transparent.</li> <li>You can use the mouse to drag the channel tile position.</li> </ul>
Copy	It is a shortcut menu button. You can copy current channel setup to one or more channels. The interface is shown as in Figure 7-28.
Save	You can click save button after you complete setup for one channel, or you can complete the whole setups and then click save button.
Refresh	Click this button to get device latest configuration information.

Click copy interface, the interface is shown as in Figure 7-28.

If you have completed the setup for channel 1, you can click 3 to copy current setup to channel 3.

Or you can click 2, 3, and 4 to copy current setup to channel 2, channel 3 and channel 4.

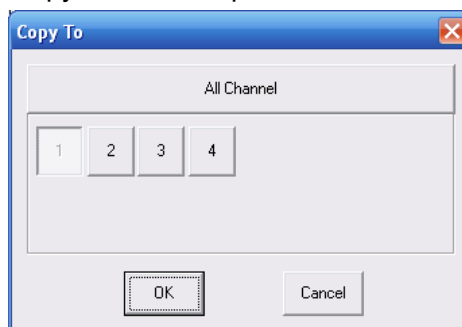

Figure 7-28

### 7.3.2.3 Schedule

Here you can set different periods for various days. There are max six periods in one day. See Figure 7-29.



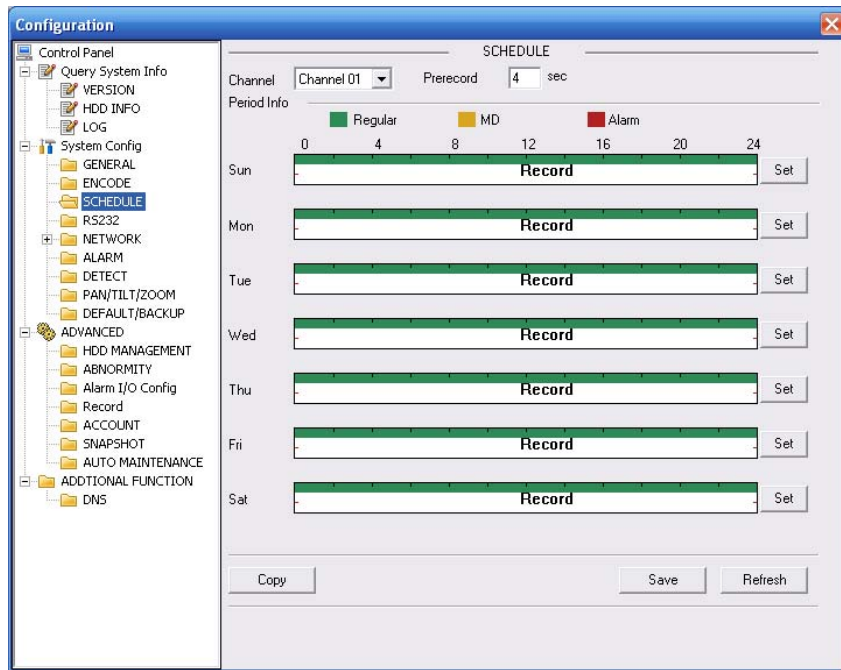

Figure 7-29



Figure 7-30

Please refer to the following sheet for detailed information.

Parameter	Function
Channel	Please select a channel first.
Pre-record	Please input pre-record value here. System can record the three to five seconds video before activating the record operation into the file. (Depends on data size).

Parameter	Function
Setup	<ul style="list-style-type: none"> <li>• In Figure 7-29, click set button, you can go to the corresponding setup interface.</li> <li>• Please set schedule period and then select corresponding record or snapshot type: schedule/snapshot, motion detection/snapshot, and alarm/snapshot.</li> <li>• Please select date (Current setup applies to current day by default. You can draw a circle before the week to apply the setup to the whole week.)</li> <li>• After complete setup, please go back to Figure 7-29 and then click save to save current time period setup.</li> </ul>
Copy	It is a shortcut menu button. You can copy current channel setup to one or more (all) channels. The interface is shown as in Figure 7-28.
Save	You can click save button after you complete setup for one channel, or you can complete the whole setups and then click save button.
Refresh	Click this button to get device latest configuration information.

### 7.3.2.4 RS232

The RS232 interface is shown as in Figure 7-31.

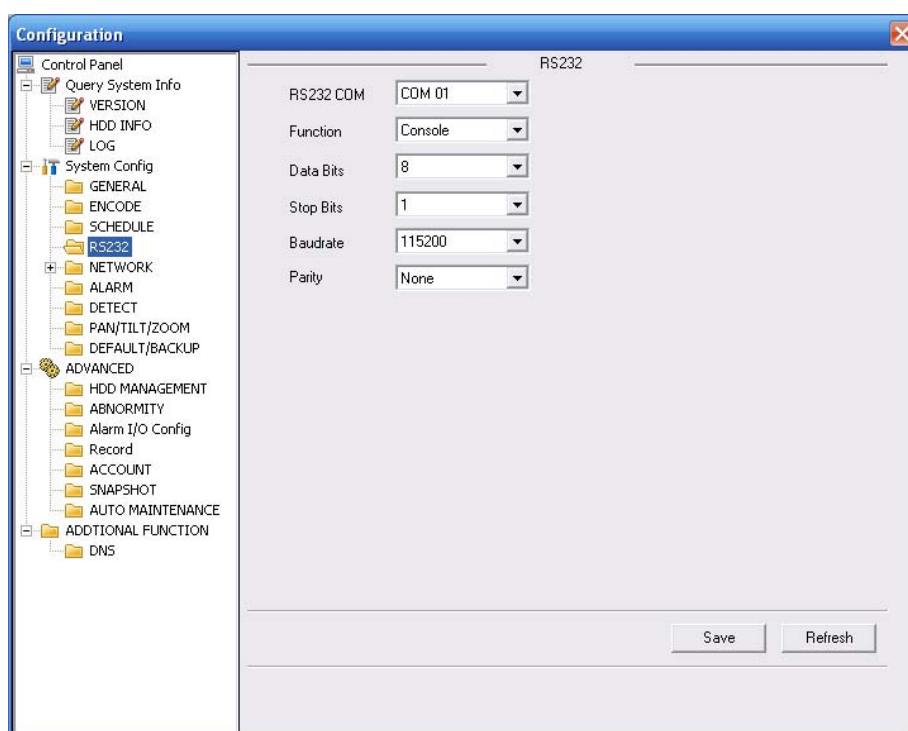

Figure 7-31

Please refer to the following sheet for detailed information.

Parameter	Function
RS232	There are two options: COM 01 and keyboard.
Function	Console is for debug. Control keyboard: Switch between RS232 and control keyboard.

Parameter	Function
	Network keyboard: COM control protocol. You can use network keyboard to control DVR via COM.
Data Bit	The value ranges from 5 to 8.
Stop Bit	There are three options: 1/1.5/2.
Baud Bit	You can select corresponding baud bit here.
Parity	There are four options: none/odd /mark/space.

System default setup is:

- Function: Console.
- Data bit: 8
- Stop bit: 1
- Baud bit: 115200
- Parity: None.

### 7.3.2.5 Network

Network interface is shown as in Figure 7-32.

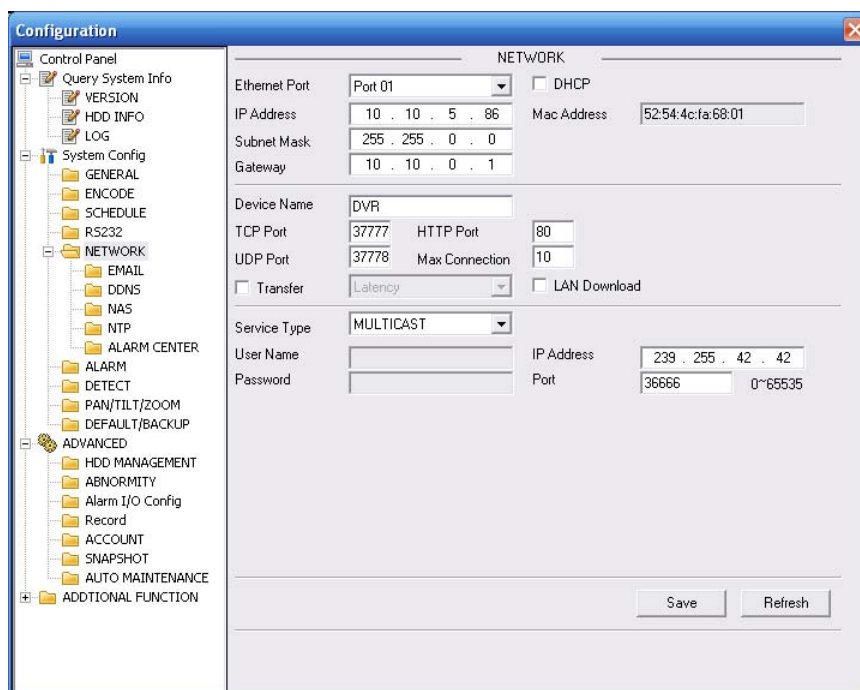

Figure 7-32

Please refer to the following sheet for detailed information.

Parameter	Function
Ethernet	Please select the network card first.
DHCP	Dynamically get IP address. You can get the device IP from the DHCP server if you enabled this function.
TCP Port	Default value is 37777.
HTTP Port	Default value is 80.
UDP Port	Default value is 37778.

Parameter		Function
Max Connection		Network user max amount. The value ranges from 0 to 10. 0 means there is no user can access current device.
Remote Host	Multiple cast group	<ul style="list-style-type: none"> <li>Set MULCAST address and port.</li> <li>Enable MULCAST function.</li> </ul>
	PPPOE	<ul style="list-style-type: none"> <li>Input the PPPoE user name and password you get from the IPS (internet service provider) and enable PPPoE function. Please save current setup and then reboot the device to get the setup activated.</li> <li>Device connects to the internet via PPPoE after reboot. You can get the IP address in the WAN from the IP address column.</li> <li>Please note if you want to reboot the device please make sure you have proper reboot right and there is no login user in current device.</li> </ul>

## Email

The email interface is shown as in Figure 7-33.

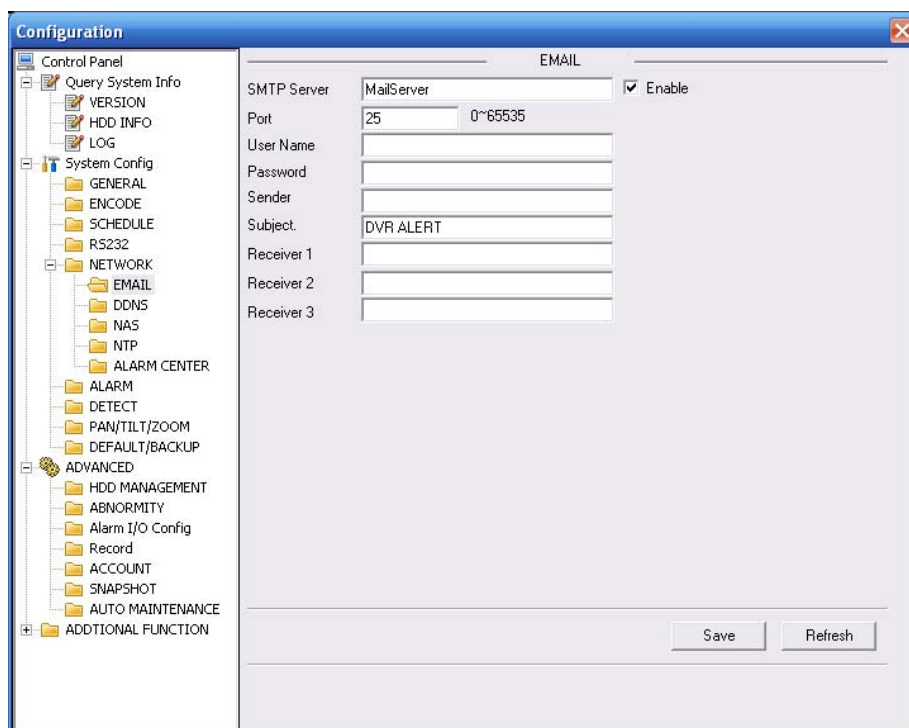

Figure 7-33

Please refer to the following sheet for detailed information.

Parameter	Function
SMTP Server	Input server address and then enable this function.
Port	Default value is 25. You can modify it if necessary.
User Name	The sender email account user name.
Password	The sender email account password.
Sender	Sender email address.

Parameter	Function
Subject	Input email subject here.
Address	Input receiver email address here. Max input three addresses.

## DDNS

The DDNS interface is shown as in Figure 7-34.

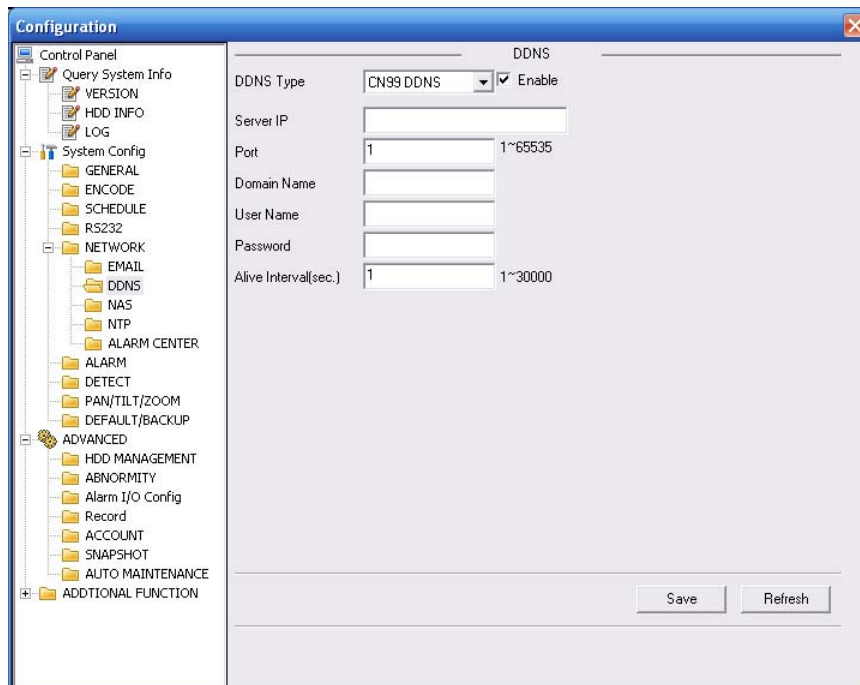

Figure 7-34

Please refer to the following sheet for detailed information.

Parameter	Function
Server Type	You can select DDNS protocol from the dropdown list and then enable DDNS function. The private DDNS protocol means you use your self-defined private protocol to realize DDNS function.
Server IP	DDNS server IP address
Server Port	DDNS server port.
Domain Name	Your self-defined domain name.
User	The user name you input to log in the server.
Password	The password you input to log in the server.
Interval	<ul style="list-style-type: none"> <li>• Device sends out alive signal to the server regularly.</li> <li>• You can set interval value between the device and DDNS server here.</li> </ul>

## NAS

NAS interface is shown as in Figure 7-35.

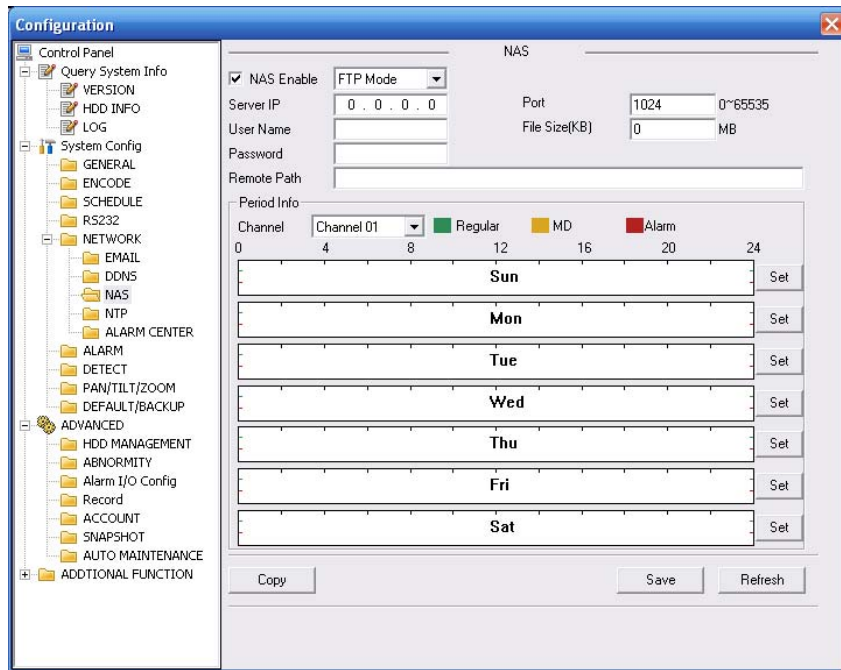

Figure 7-35

Please refer to the following sheet for detailed information.

Parameter	Function
NAS enable	Please select network storage protocol and then enable NAS function.
Server IP	Input remote storage server IP address.
Port	Input Remote storage server port number.
User Name	Log in user account.
File length	The file length you upload to the FTP. When setup is larger than the actual file length, system will upload the whole file. When setup here is smaller than the actual file length, system only uploads the set length and auto ignore the left section. When interval value is 0, system uploads all corresponding files.
Password	The password you need to log in the server.
Remote Path	Remote storage file path.
Save	You can click save button after you complete setup for one channel, or you can complete the whole setups and then click save button.
Refresh	Click this button to get device latest configuration information.

**NTP**

The NTP interface is shown as in Figure 7-36.

Here you can realize network time synchronization. Please enable current function and then input server IP, port number, time zone and update interval.

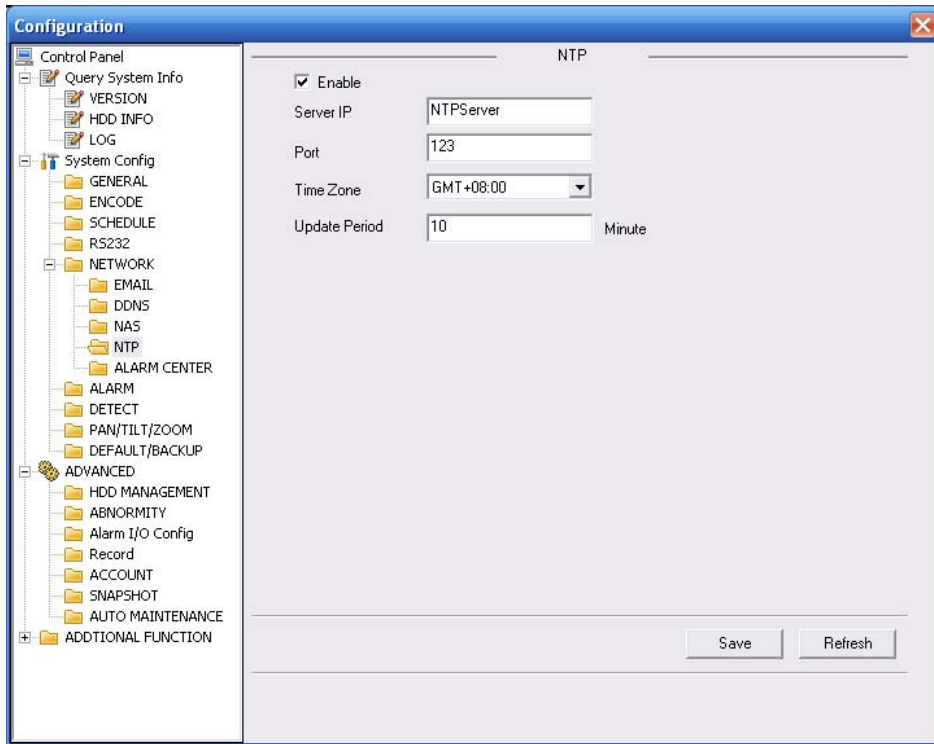

Figure 7-36

### Alarm Centre

Alarm centre interface is shown as below.

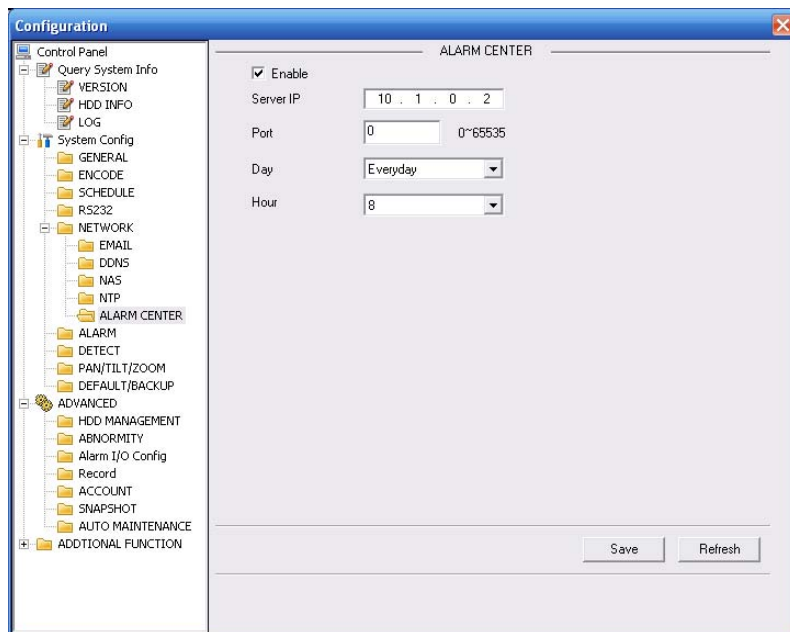

Figure 7-37

### 7.3.2.6 Alarm

Alarm setup interface is shown as in Figure 7-38.

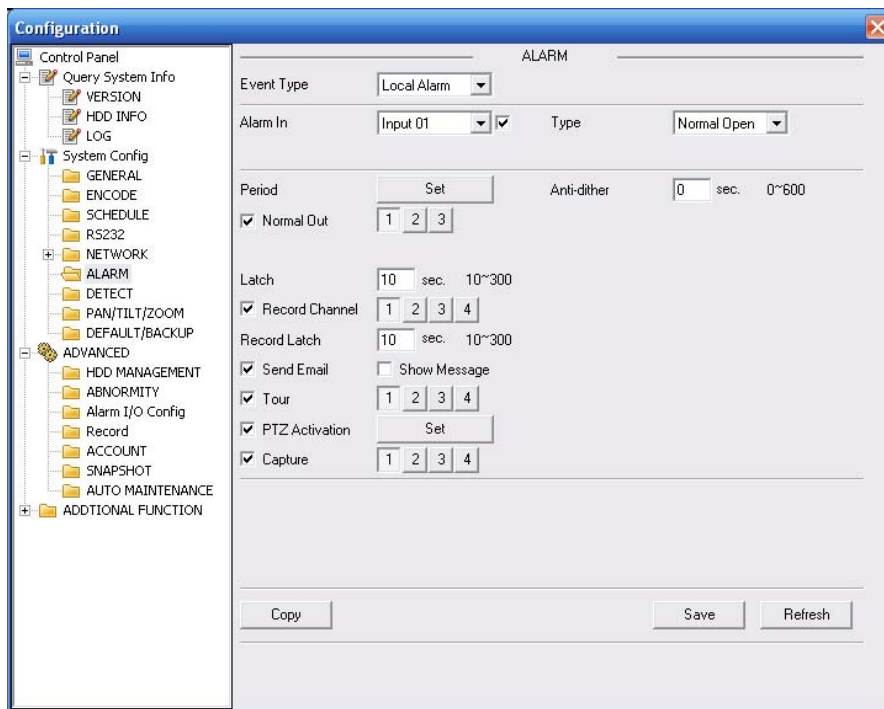

Figure 7-38

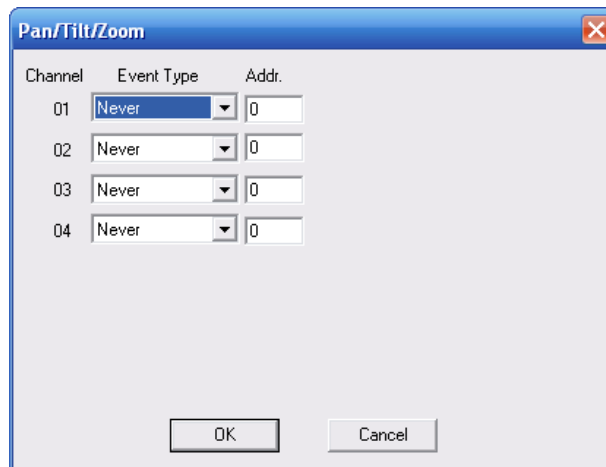

Figure 7-39

Please refer to the following sheet for detailed information.

Parameter	Function
Event Type	It includes local alarm/network alarm. Local alarm: Device detects alarm from input port. Network: Device detects alarm from network.
Alarm in	Select corresponding alarm channel.
Enable	You need to draw a circle here so that system can detect the alarm signal.
Type	There are two options: normal open and normal close. NO becomes activated in low voltage, NC becomes activated in high voltage.



Parameter	Function
Period	Alarm record function becomes activated in the specified periods. There are six periods in one day. Please draw a circle to enable corresponding period. Select date. If you do not select, current setup applies to today only. You can select all week column to apply to the whole week. Click OK button, system goes back to alarm setup interface, please click save button to exit.
Anti-dither	System only memorizes one event during the anti-dither period. The value ranges from 0 to 15s.
Normal Out	Enable alarm activation function. You need to select alarm output port so that system can activate corresponding alarm device when alarm occurs.
Alarm Latch	System can delay the alarm output for specified time after alarm ended. The value ranges from 10 seconds to 300 seconds.
Record Channel	System auto activates current channel to record once alarm occurs (working with alarm activation function). Please note current device shall be in auto record mode (Chapter 4.4 Schedule).
Record Latch	System can delay the record for specified time after alarm ended. The value ranges from 10s to 300s.
Email	Please draw a circle to enable email function. System can send out email to alert you when alarm occurs and ends.
Tour	Display the selected video in local monitor window. This function is not available in current device.
PTZ activation	Here you can set PTZ movement when alarm occurs. Such as go to preset x when there is an alarm. The PTZ configuration events include preset, tour, and pattern.
Capture	You need to input capture channel number so that system can backup snapshot file when alarm occurs.
Copy	It is a shortcut menu button. You can copy current channel setup to one or more (all) channels.
Save	You can click save button after you complete setup for one channel, or you can complete the whole setups and then click save button.
Refresh	Click this button to get device latest configuration information.

### 7.3.2.7 Detect

Analysis the video, system enable motion detection alarm when it detects the motion signal reached the specified sensitivity.

The detection interface is shown as in Figure 7-40.

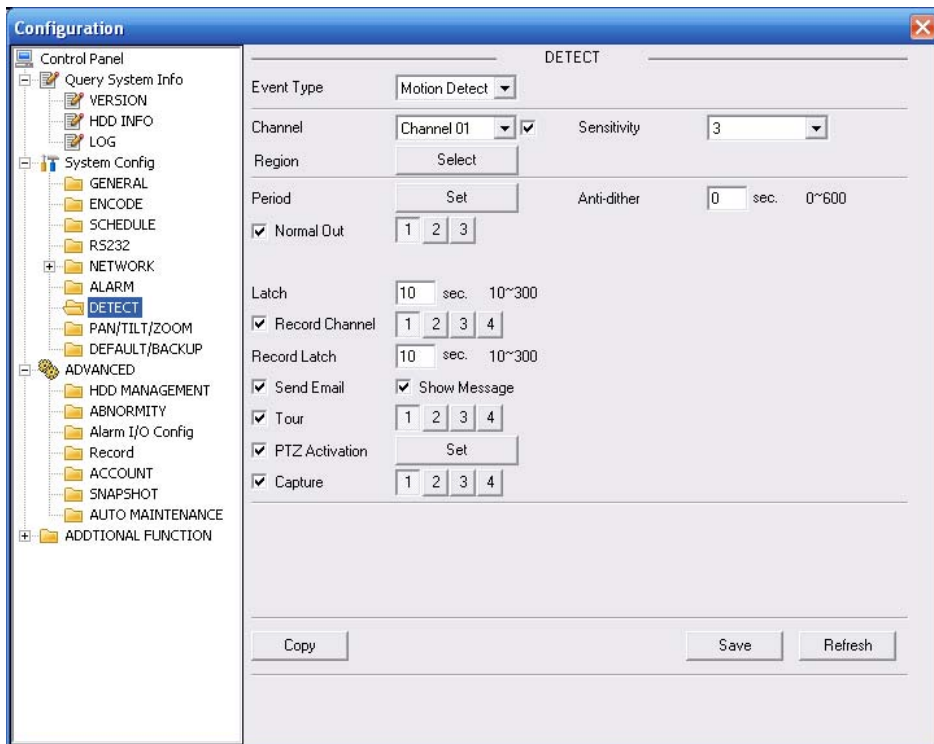

Figure 7-40

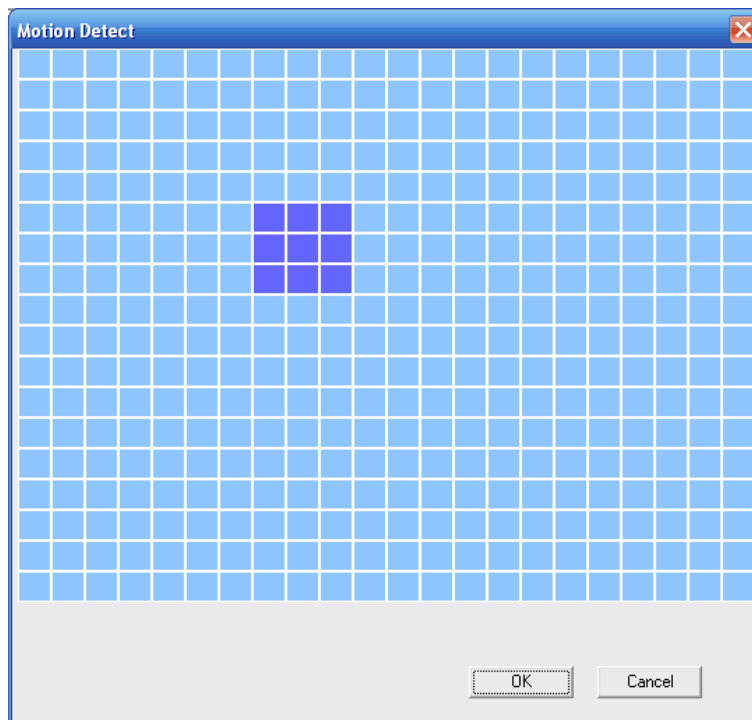

Figure 7-41

Please refer to the following sheet for detailed information.

Parameter	Function
Event Type	There are three types: Motion detection/video loss/Camera Masking.
Channel	Select channel name from the dropdown list.

Parameter	Function
Enable	You need to draw a circle to enable motion detection function.
Sensitivity	There are six levels. The sixth level has the highest sensitivity.
Region	<ul style="list-style-type: none"> <li>• There are six levels. The sixth level has the highest sensitivity.</li> <li>• Region: If you select motion detection type, you can click this button to set motion detection zone. The interface is shown as in Figure 7-41. There are PAL 22X18/NTSC 22X15 zones. Right click mouse you can go to full-screen display mode. Do remember clicking OK button to save your motion detection zone setup.</li> </ul>
Period	<ul style="list-style-type: none"> <li>• Motion detection function becomes activated in the specified periods.</li> <li>• There are six periods in one day. Please draw a circle to enable corresponding period.</li> <li>• Select date. If you do not select, current setup applies to today only. You can select all week column to apply to the whole week.</li> <li>• Click OK button, system goes back to motion detection interface; please click save button to exit.</li> </ul>
Anti-dither	System only memorizes one event during the anti-dither period. The value ranges from 0s to 15s.
Normal out	<ul style="list-style-type: none"> <li>• There is 2-channel alarm output.</li> <li>• Corresponding to motion detection alarm output port(multiple choices)</li> <li>• Enable alarm activation function. You need to select alarm output port so that system can activate corresponding alarm device when alarm occurs.</li> </ul>
Alarm latch	System can delay the alarm output for specified time after alarm end. The value ranges from 10s to 300s.
Record channel	System auto activates motion detection channel (multiple choices) to record once alarm occurs (working with motion detection function). Please note you need to go to Chapter 4.4 Schedule to set motion detection record period and go to chapter 4.2 Manual Record to set current period as auto record.
Record latch	System can delay the record for specified time after alarm ended. The value ranges from 10s to 300s.
Email	If you enabled this function, System can send out email to alert you when alarm occurs and ends.
Tour	<ul style="list-style-type: none"> <li>• Display the selected video in local monitor window.</li> </ul> This function is not available in current device.
PTZ Activation	<ul style="list-style-type: none"> <li>• Here you can set PTZ movement when alarm occurs. Such as go to preset x when there is an alarm.</li> </ul>
Capture	You need to input capture channel number so that system can backup motion detection snapshot file.
Copy	It is a shortcut menu button. You can copy current channel setup to one or more (all) channels.
Save	You can click save button after you complete setup for one channel, or you can complete the whole setups and then click save button.

Parameter	Function
Refresh	Click this button to get device latest configuration information.

### 7.3.2.8 PTZ

PTZ interface is shown as in Figure 7-42

Please note, before operation please make sure you have set speed dome address. And DVR and speed dome connection is OK.

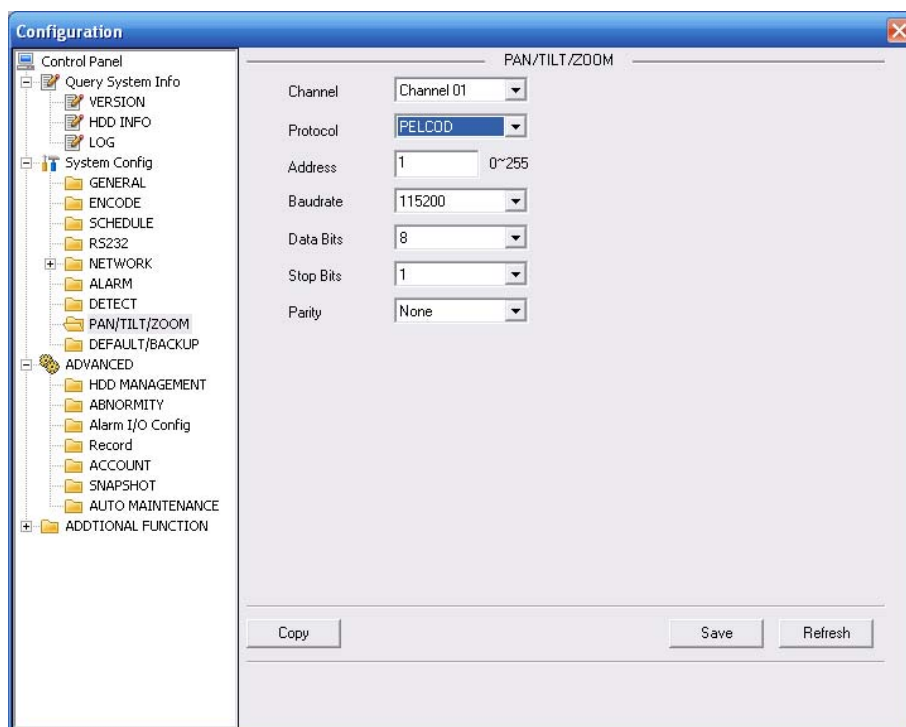

Figure 7-42

Please refer to the TILTING sheet for detailed information.

Parameter	Function
Channel	You can select monitor channel from the dropdown list. .
Protocol	Select the corresponding dome protocol.(such as PELCCOD)
Address	Set corresponding dome address. Default value is 1. Please note your setup here shall comply with your dome address; otherwise you can not control the speed dome.
Baud Rate	Select the dome baud rate. Default setup is 9600.
Data Bit	Default setup is 8. Please set according to the speed dome dial switch setup.
Stop bit	Default setup is 1. Please set according to the speed dome dial switch setup.
Parity	Default setup is none. Please set according to the speed dome dial switch setup.
Save	You can click save button after you complete setup for one channel, or you can complete the whole setups and then click save button.
Refresh	Click this button to get device latest configuration information.

### 7.3.2.9 Default & Backup

Default: Restore factory default setup. You can select corresponding items.

Backup: Export current configuration to local PC or import configuration from current PC.

Please refer to Figure 7-43.

Please note system can not restore some information such as network IP address.

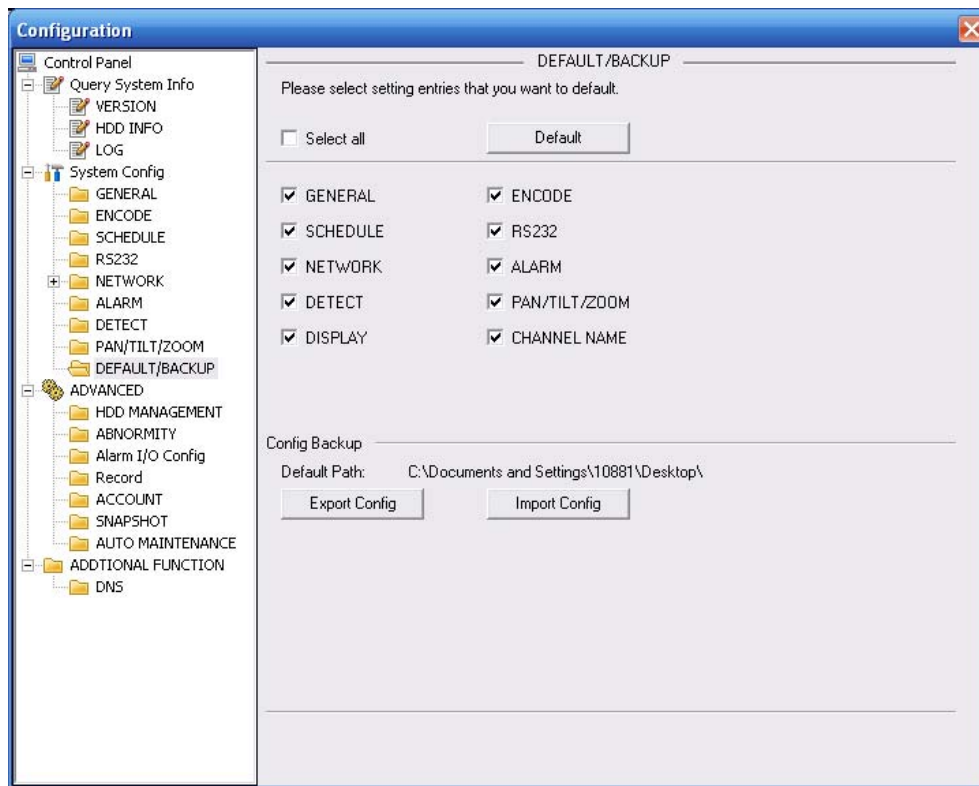

Figure 7-43

Please refer to the following sheet for detailed information.

Parameter	Function
Select All	Restore factory default setup.
Export Configuration	Export system configuration to local PC.
Import Configuration	Import configuration from PC to the system.

### 7.3.3 Advanced

#### 7.3.3.1 HDD Management

HDD management includes net storage management and local storage management.

Please note, if you want to use local storage function, your storage device need to support current function.

Please select the storage device first and then you can see the items on your right become valid.

You can check the corresponding item here. See Figure 7-44.

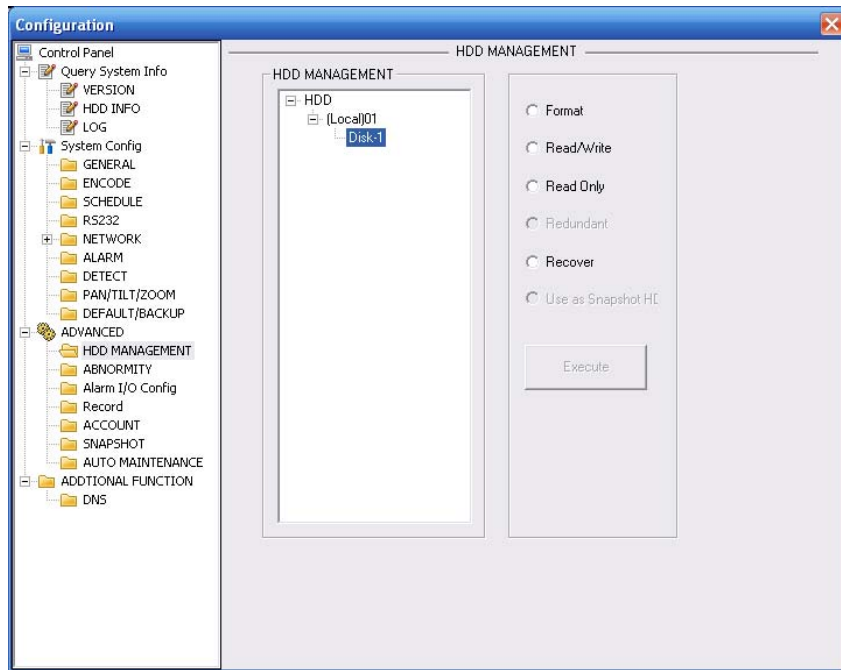

Figure 7-44

Please refer to the following sheet for detailed information.

Parameter	Function
Format	Clear data in the disk.
Read/write	Set current SD card as read/write
Read only	Set current card as read.
Recover	Recover data after error occurs.

Please note system needs to reboot to activate current setup.

### 7.3.3.2 Alarm I/O

Here you can search alarm output status. See Figure 7-45.

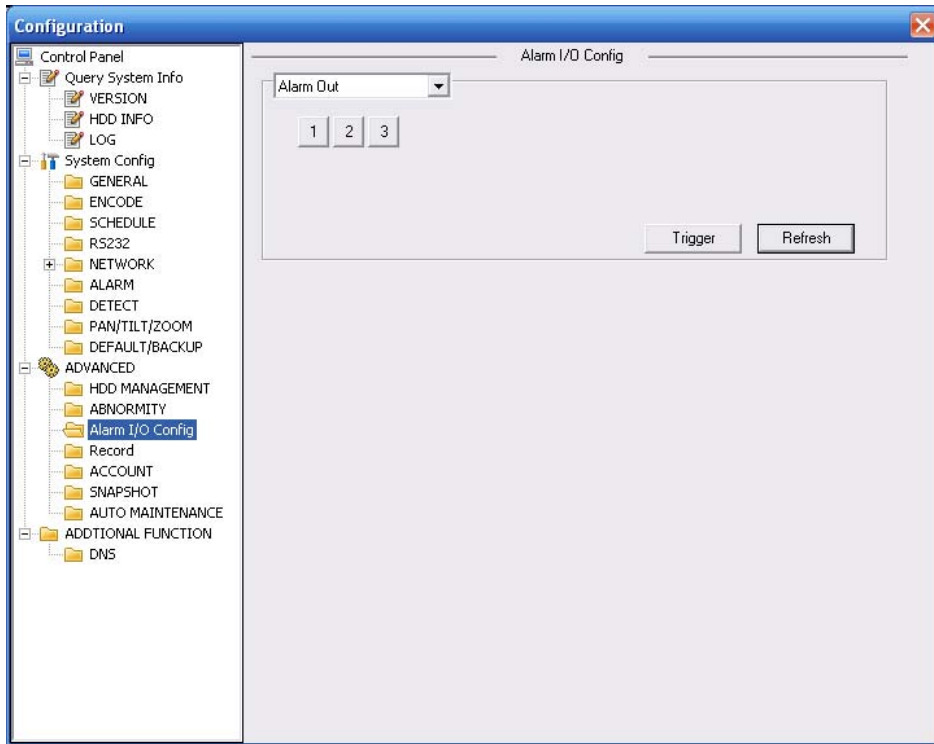

Figure 7-45

Please refer to the following sheet for detailed information.

Parameter	Function
Alarm output	There are three output channels(Multiple choices).
Activate	Enable/disable alarm output device.
Refresh	Search alarm output status.

### 7.3.3.3 Record

Record control interface is shown as in Figure 7-46.

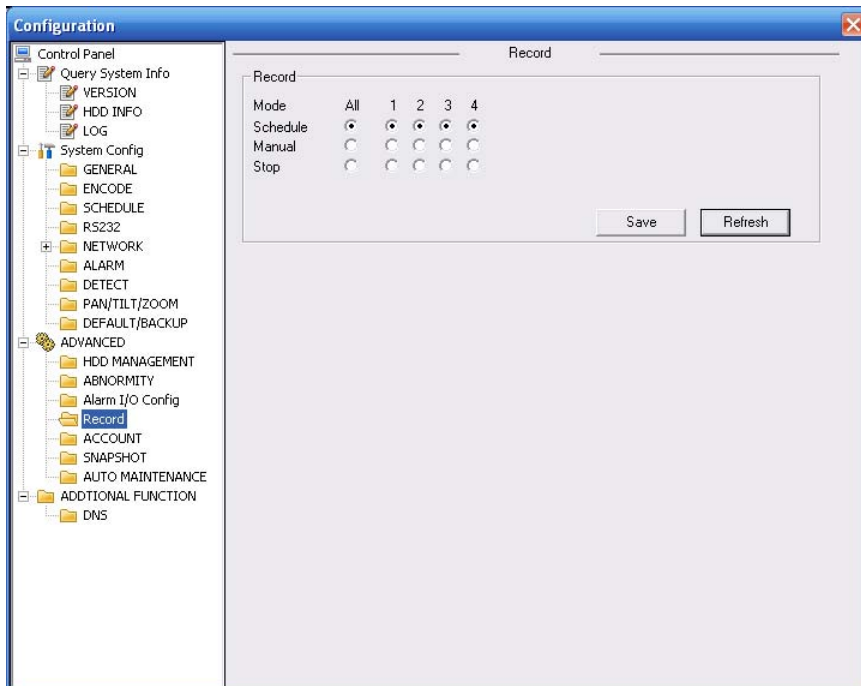

Figure 7-46

Please refer to the following sheet for detailed information.

Parameter	Function
Auto	System enables auto record function as you set in record schedule setup.
Manual	Enable corresponding channel to record no matter what period applied in the record setup.
Stop	Stop current channel record no matter what period applied in the record setup.

Operation here is the same to chapter 4.2 Manual Record. Please refer to chapter 4.2 for detail information.

### 7.3.3.4 Account

Here you can add, remove user or modify password. See Figure 7-47.

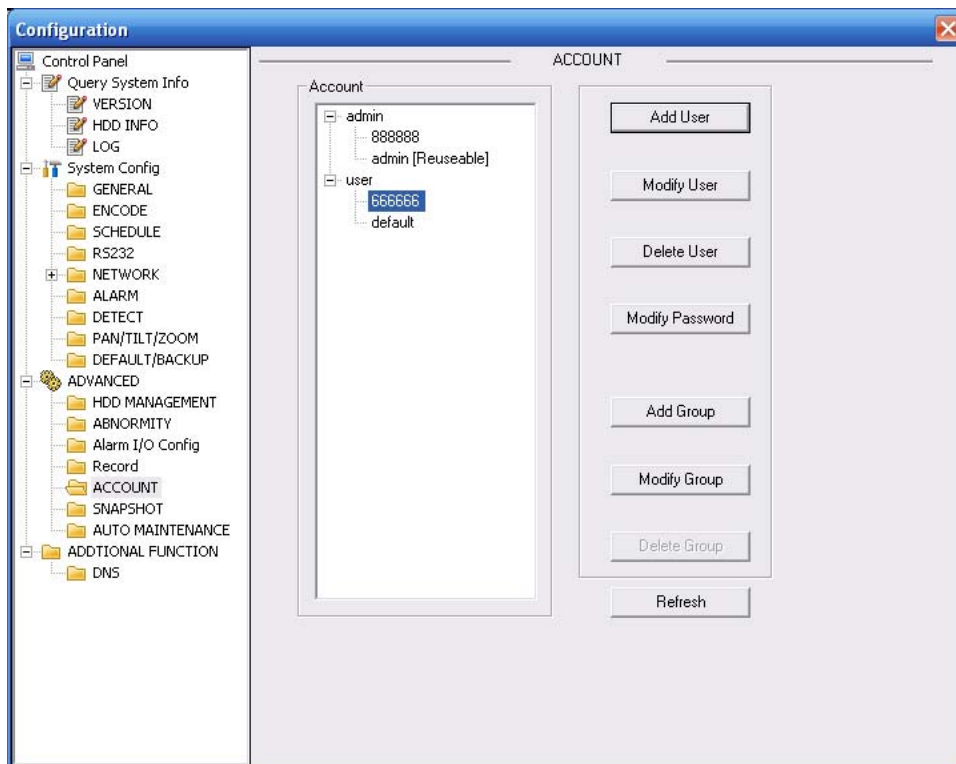

Figure 7-47

### 7.3.3.5 Auto Maintenance

Here you can select auto reboot and auto delete old files interval from the dropdown list. See Figure 7-48.



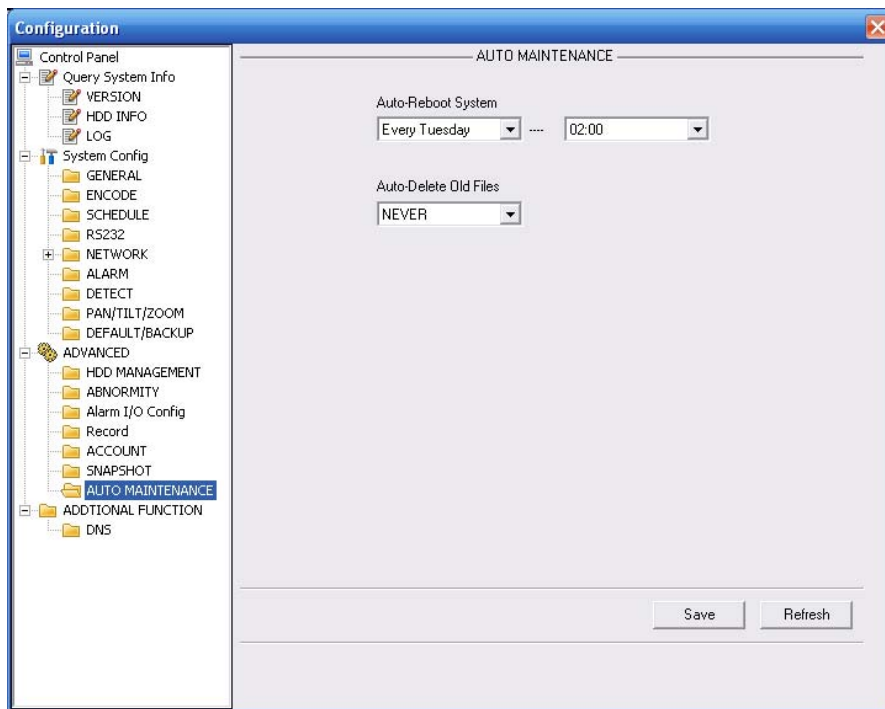

Figure 7-48

### 7.3.3.6 Snapshot

Snapshot interface is shown as in Figure 7-49.

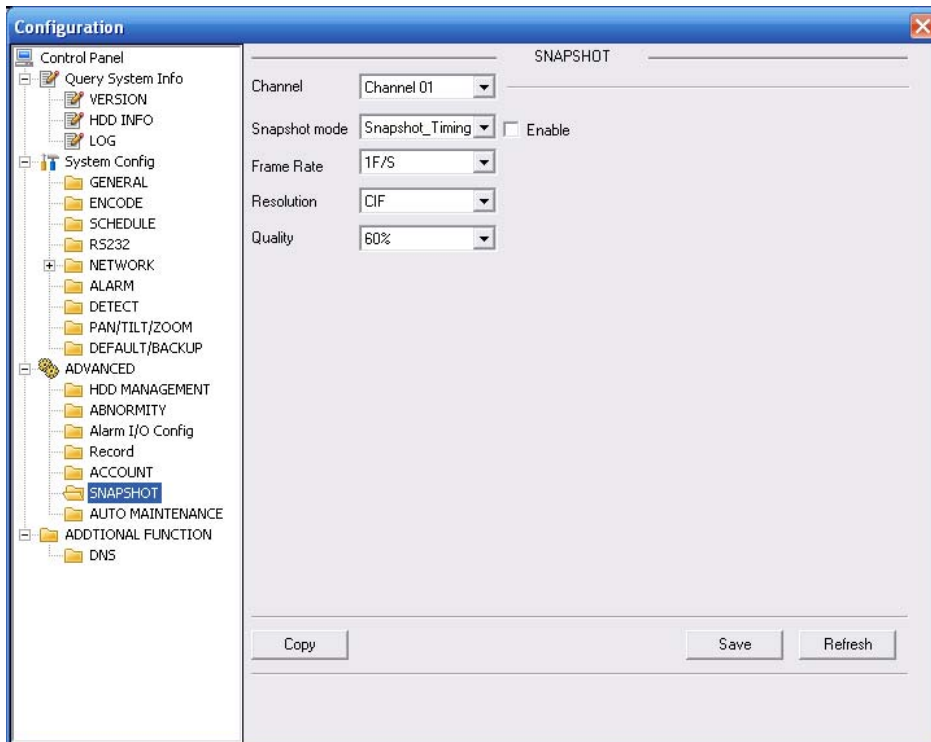

Figure 7-49

Please refer to the following sheet for detailed information.

Parameter	Function
Channel	It is the monitor channel.
Snapshot mode	There are two modes: Timing and activation.

Frame rate	You can select from the dropdown list. The value ranges from 1f/s to 7f/s.
Resolution	You can select from the dropdown list. For 16 series DVR: Channel 1 and channel 9 support D1/CIF/QCIF. Channel 2 to channel 8, channel 10 to channel 16 supports CIF/QCIF.
Quality	You can select from the dropdown list. Here is for you to set video quality. There are six options: 10%、30%、50%、60%、80%、100%。 100% is the best quality.

### 7.3.3.7 Abnormity

The abnormity interface is shown as below.

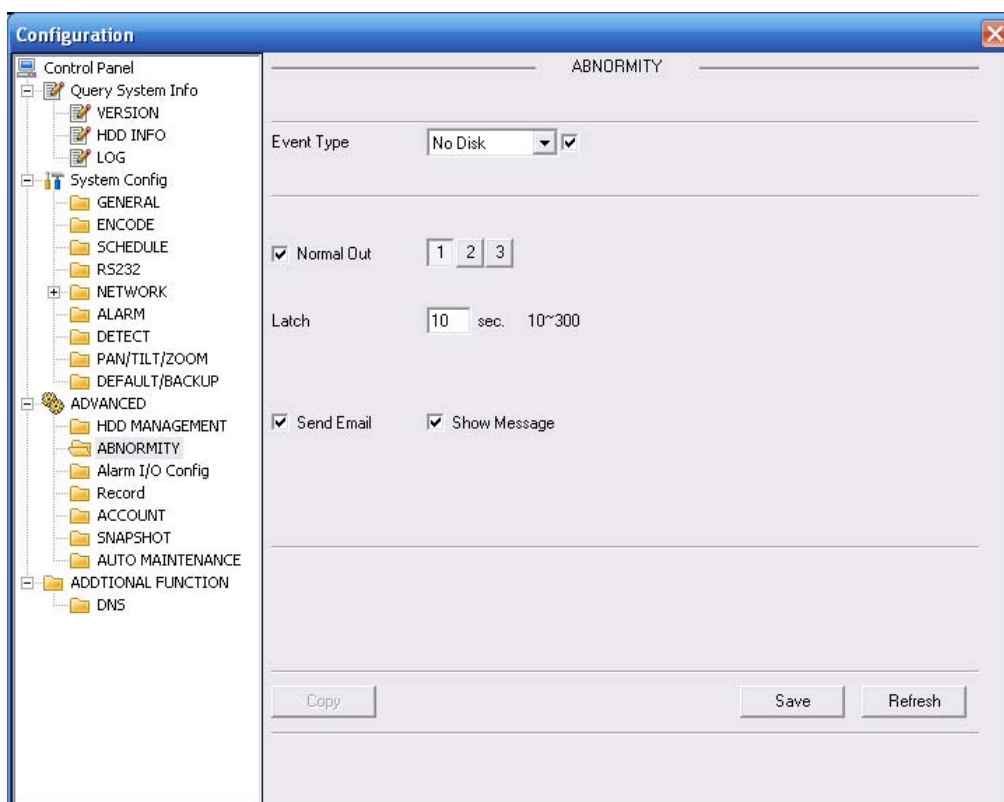

Figure 7-50

Please refer to the following sheet for detailed information.

Parameter	Function
Event Type	<ul style="list-style-type: none"> <li>The abnormal events include: no disk, no space, disk error, net error.</li> <li>You need to draw a circle to enable this function.</li> </ul>
Normal Out	The corresponding alarm activation output channel when alarm occurs, There are three channels. The 3-ch is the controllable 12V output.
Latch	The alarm output can delay for the specified time after alarm stops. Then system disables alarm and corresponding activation output. The value ranges from 10s to 300s.
Send email	If you enable this function, system can send out email to alarm the specified user.

Parameter	Function
Show message	System can display alarm information in local DVR screen.

### 7.3.4 Additional Function

#### 7.3.4.1 DNS

Here you can set server or local operator DNS address. See Figure 7-51.

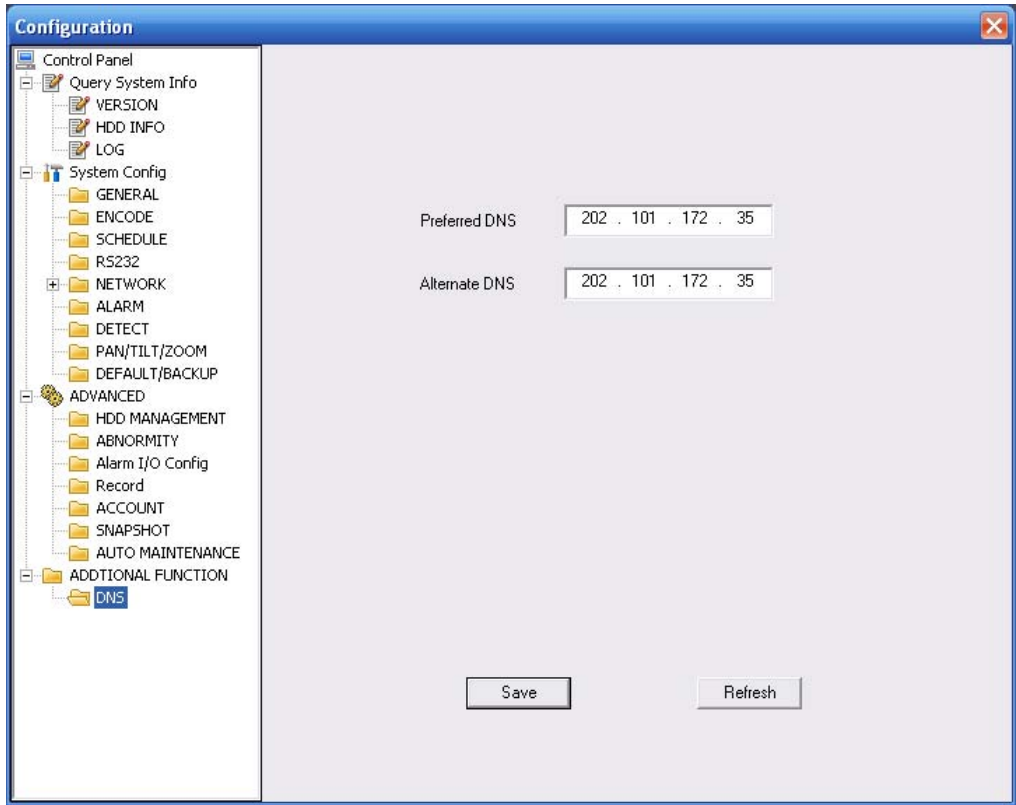

Figure 7-51

## 7.4 Search

Click search button, you can see an interface is shown as in Figure 7-52.

Please select record playback mode, and then select start time, end time and channel. Then please click search button, you can see the corresponding files in the list.

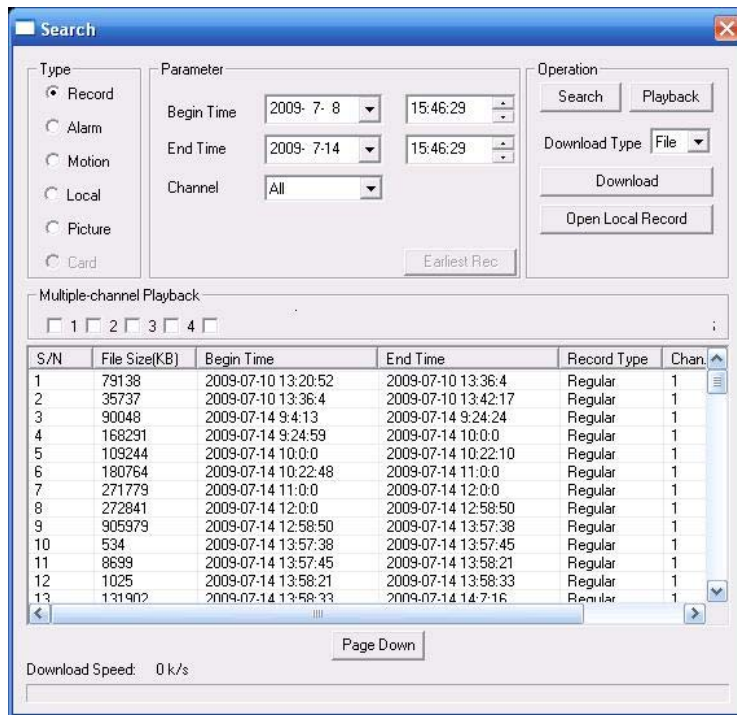

Figure 7-52

Select the file(s) you want to download and then click download button, system pops up a dialogue box shown as in Figure 7-53 , then you can specify file name and path to download the file(s) to your local pc.

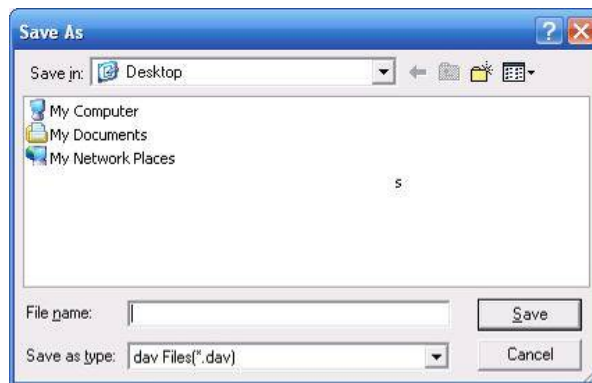

Figure 7-53

Now you can see system begins download and the download button becomes stop button. You can click it to terminate current operation.

At the bottom of the interface, there is a process bar for your reference. See Figure 7-54.

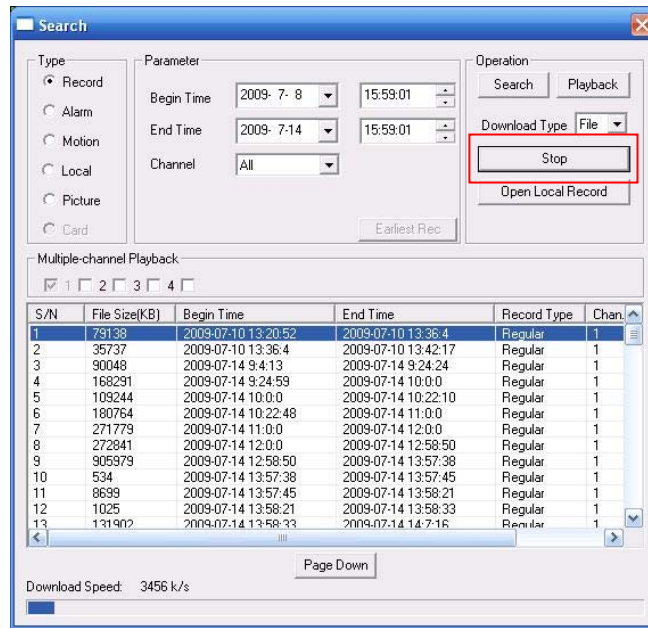

Figure 7-54

When download completed, you can see a dialogue box shown as in Figure 7-54. Please click OK to exit.



Figure 7-55

Please refer to the following sheet for detailed information.

Type	Parameter	Function
Type	Record	Search general record, alarm record and motion detection record.
	Alarm	Search alarm record.
	Motion Detection	Search motion detection record.
	Local	Search local record.
	Snapshot	Search snapshot file.
	Card	This function is not available in current device.
Item	Begin time	Set the file start time. You can select from the dropdown list.
	End time	Set the file end time. You can select from the dropdown list
	Channel	Select the channel from the dropdown list.
Operation	Search	Click this button you can view the recorded file matched your requirements.
	Playback	Select the file first and then click playback button to view the video.

Type	Parameter	Function
	Download type	Download by file: Select the file(s) and then click download button. Download by time: Download the recorded file(s) within your specified period.
	Download	Select the file you need (multiple choices) and then click download button, you can see system pops up a dialogue box. See Figure 7-53. Input the downloaded file name, specify the path and then click OK button. You can see system begins download and the download becomes stop button. There is a progress bar for your reference.
	Open local record	Select local record to play.
Multiple-channel playback		System supports playback one file in several monitor channels.

During the playback process, you can see there are control buttons such as play, pause, stop, slow play and fast play in the play process bar. You can view current playback file channel name, time and data statistics.

In the search result interface, you can select one or more files to download to your local PC. The playback control bar is shown as below. See Figure 7-56.

- 1: Play
- 2: Pause
- 3: Stop
- 4: Slow play
- 5: Fast play

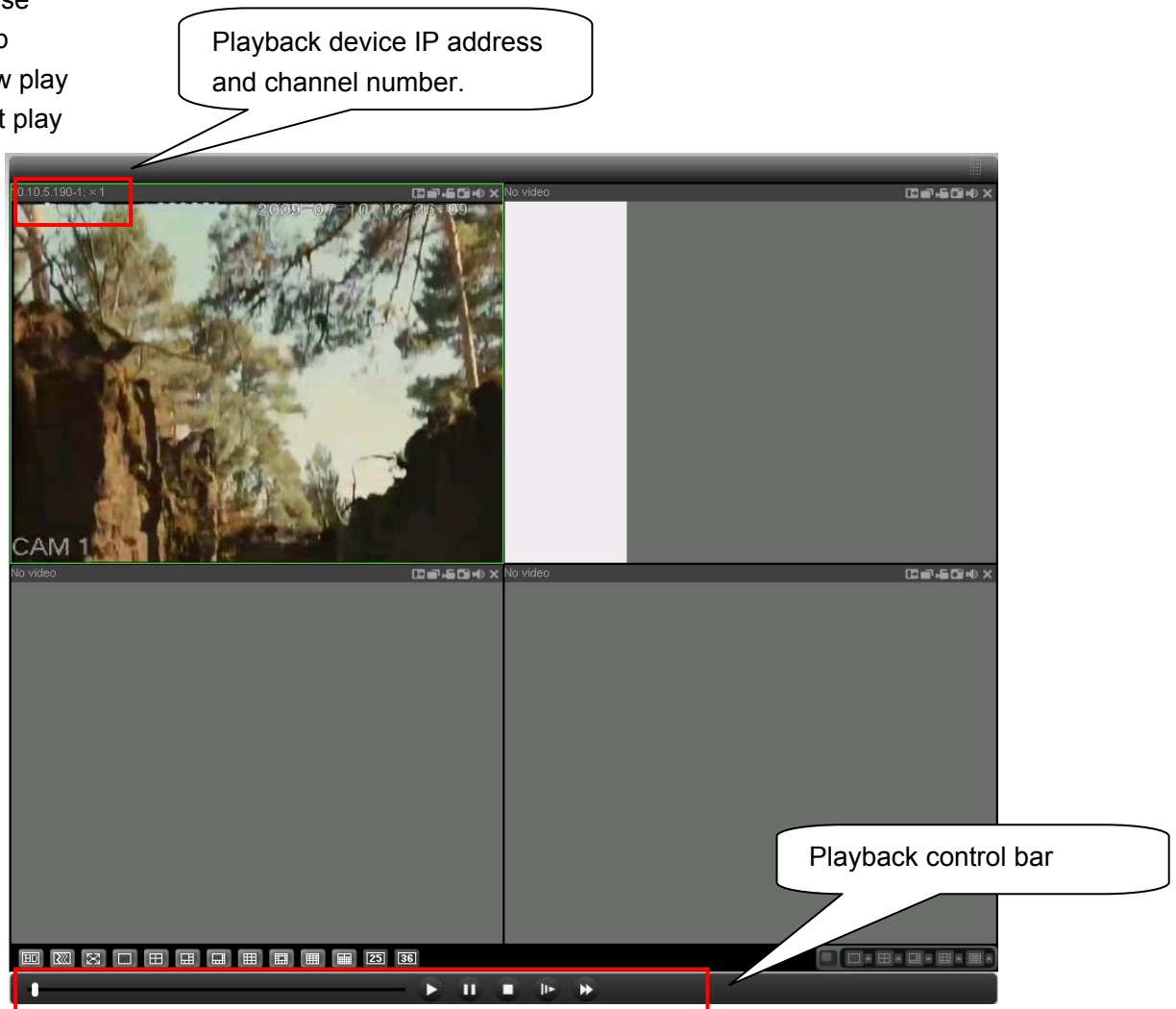

Figure 7-56

## 7.5 Alarm

Click alarm function, you can see an interface is shown as in Figure 7-57.

Here you can set device alarm type and alarm sound setup.

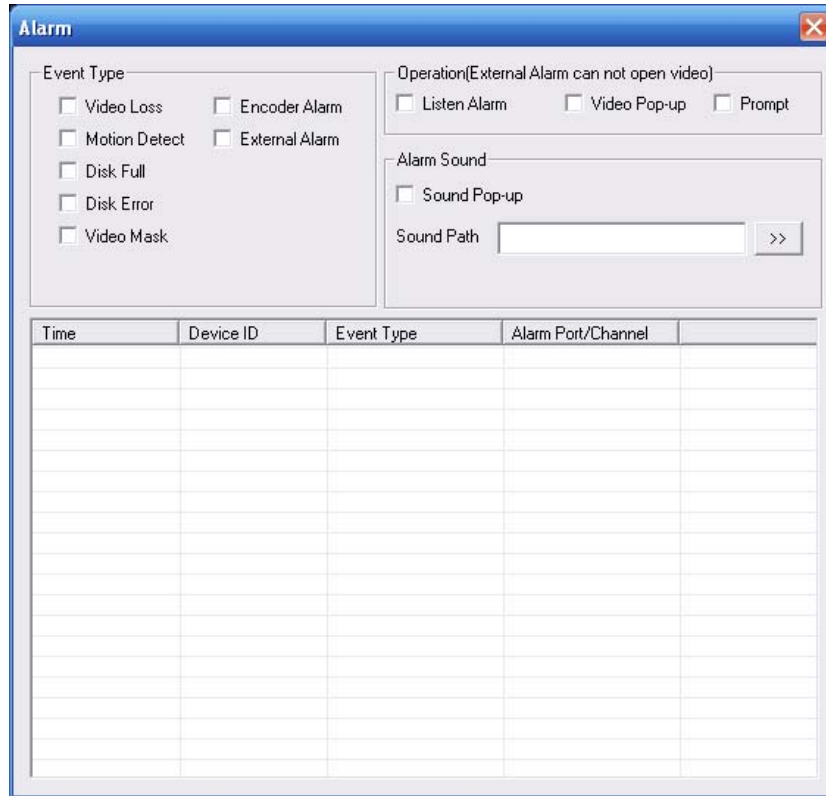

Figure 7-57

Please refer to the following sheet for detailed information.

Type	Parameter	Function
Alarm Type	Video loss	System alarms when video loss occurs.
	Motion detection	System alarms when motion detection alarm occurs,
	Disk full	System alarms when disk is full.
	Disk error	System alarms when disk error occurs.
	Camera masking	System alarms when camera is viciously masking.
	Encode alarm	System alarms when peripheral device alarms.
	External alarm	Alarm input device sends out alarm.
Operation	Listen alarm	System notifies web when alarm occurs (you select from the above event type), and then web can notify user.
	Video	When alarm occurs, system auto enables video monitor. This function only applies to video detection alarm (motion detection, video loss and camera masking).
	Prompt	Automatically pops up alarm dialogue box.
	Sound pop up	System sends out alarm sound when alarm occurs. You can specify as you wish.
	Path	Here you can specify alarm sound file.

## 7.6 About

Click about button, you can view current web client information. See Figure 7-58.

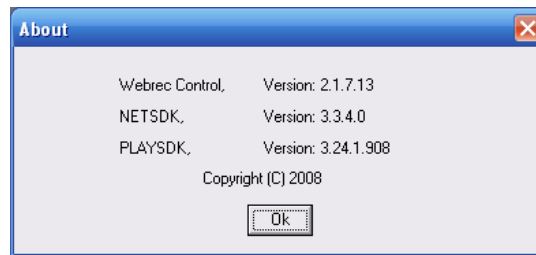

Figure 7-58

## 7.7 Log out

Click log out button, system goes back to log in interface. See Figure 7-59.

You need to input user name and password to login again.

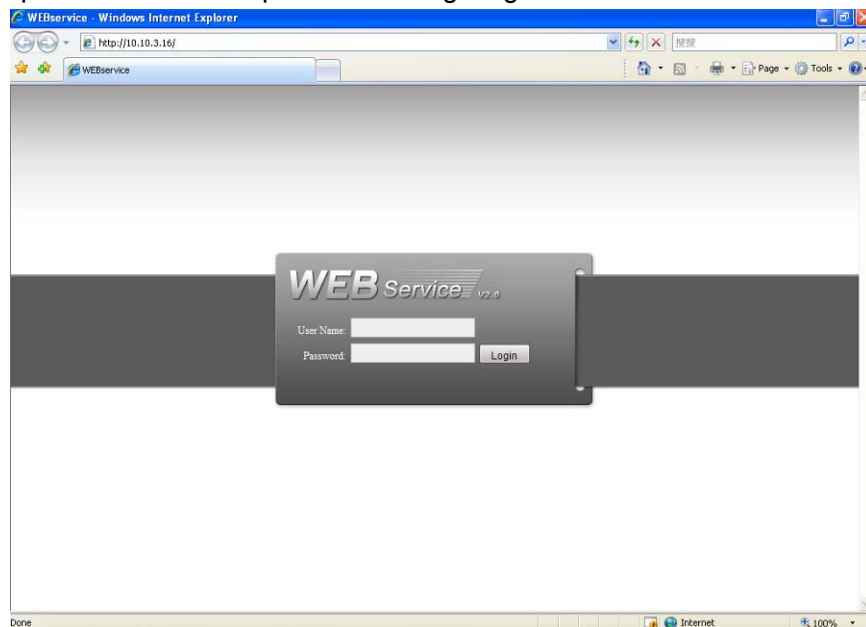

Figure 7-59

## 7.8 Un-install Web Control

You can use web un-install tool “uninstall web.bat” to un-install web control.

**Please note, before you un-installation, please close all web pages, otherwise the un-installation might result in error.**



## 8 Professional Surveillance System

Besides Web, you can use our Professional Surveillance Software (PSS) to login the device. For detailed information, please refer to *PSS user's manual*.

## 9 FAQ

### 1. DVR can not boot up properly.

There are following possibilities:

- Input power is not correct.
- Power connection is not correct.
- Power switch button is damaged.
- Program upgrade is wrong.
- HDD malfunction or something wrong with HDD ribbon.
- Seagate DB35.1, DB35.2, SV35 or Maxtor 17-g has compatibility problem. Please upgrade to the latest version to solve this problem.
- Front panel error.
- Main board is damaged.

### 2. DVR often automatically shuts down or stops running.

There are following possibilities:

- Input voltage is not stable or it is too low.
- HDD malfunction or something wrong with the ribbon.
- Button power is not enough.
- Front video signal is not stable.
- Working environment is too harsh, too much dust.
- Hardware malfunction.

### 3. System can not detect hard disk.

There are following possibilities:

- HDD is broken.
- HDD ribbon is damaged.
- HDD cable connection is loose.
- Main board SATA port is broken.

### 4. There is no video output whether it is one-channel, multiple-channel or all-channel output.

There are following possibilities:

- Program is not compatible. Please upgrade to the latest version.
- Brightness is 0. Please restore factory default setup.
- There is no video input signal or it is too weak.
- Check privacy mask setup or your screen saver.
- DVR hardware malfunctions.

### 5. Real-time video color is distorted.

There are following possibilities:

- When using BNC output, NTSC and PAL setup is not correct. The real-time video becomes black and white.
- DVR and monitor resistance is not compatible.
- Video transmission is too long or degrading is too huge.

- DVR color or brightness setup is not correct.

#### **6. Can not search local records.**

There are following possibilities:

- HDD ribbon is damaged.
- HDD is broken.
- Upgraded program is not compatible.
- The recorded file has been overwritten.
- Record function has been disabled.

#### **7. Video is distorted when searching local records.**

There are following possibilities:

- Video quality setup is too low.
- Program read error, bit data is too small. There is mosaic in the full screen. Please restart the DVR to solve this problem.
- HDD data ribbon error.
- HDD malfunction.
- DVR hardware malfunctions.

#### **8. There is no audio when monitor.**

There are following possibilities:

- It is not a power picker.
- It is not a power acoustics.
- Audio cable is damaged.
- DVR hardware malfunctions.

#### **9. There is audio when monitor but there is no audio when system playback.**

There are following possibilities:

- Setup is not correct. Please enable audio function
- Corresponding channel has no video input. Playback is not continuous when the screen is blue.

#### **10. Time display is not correct.**

There are following possibilities:

- Setup is not correct
- Battery contact is not correct or voltage is too low.
- Crystal is broken.

#### **11. DVR can not control PTZ.**

There are following possibilities:

- Front panel PTZ error
- PTZ decoder setup, connection or installation is not correct.
- Cable connection is not correct.
- PTZ setup is not correct.
- PTZ decoder and DVR protocol is not compatible.

- PTZ decoder and DVR address is not compatible.
- When there are several decoders, please add 120 Ohm between the PTZ decoder A/B cables furthest end to delete the reverberation or impedance matching. Otherwise the PTZ control is not stable.
- The distance is too far.

### **12. Motion detection function does not work.**

There are following possibilities:

- Period setup is not correct.
- Motion detection zone setup is not correct.
- Sensitivity is too low.
- For some versions, there is hardware limit.

### **13. Can not log in client-end or web.**

There are following possibilities:

- For Windows 98 or Windows ME user, please update your system to Windows 2000 sp4. Or you can install client-end software of lower version. Please note right now, our DVR is not compatible with Windows VISTA control.
- ActiveX control has been disabled.
- No dx8.1 or higher. Please upgrade display card driver.
- Network connection error.
- Network setup error.
- Password or user name is invalid.
- Client-end is not compatible with DVR program.

### **14. There is only mosaic no video when preview or playback video file remotely.**

There are following possibilities:

- Network fluency is not good.
- Client-end resources are limit.
- There is multiple-cast group setup in DVR. This mode can result in mosaic. Usually we do not recommend this mode.
- There is privacy mask or channel protection setup.
- Current user has no right to monitor.
- DVR local video output quality is not good.

### **15. Network connection is not stable.**

There are following possibilities:

- Network is not stable.
- IP address conflict.
- MAC address conflict.
- PC or DVR network card is not good.

### **16. Burn error /USB back error.**

There are following possibilities:

- Burner and DVR are in the same data cable.

- System uses too much CPU resources. Please stop record first and then begin backup.
- Data amount exceeds backup device capacity. It may result in burner error.
- Backup device is not compatible.
- Backup device is damaged.

#### **17. Keyboard can not control DVR.**

There are following possibilities:

- DVR serial port setup is not correct
- Address is not correct
- When there are several switchers, power supply is not enough.
- Transmission distance is too far.

#### **18. Alarm signal can not been disarmed.**

There are following possibilities:

- Alarm setup is not correct.
- Alarm output has been open manually.
- Input device error or connection is not correct.
- Some program versions may have this problem. Please upgrade your system.

#### **19. Alarm function is null.**

There are following possibilities:

- Alarm setup is not correct.
- Alarm cable connection is not correct.
- Alarm input signal is not correct.
- There are two loops connect to one alarm device.

#### **20. Remote control does not work.**

There are following possibilities:

- Remote control address is not correct.
- Distance is too far or control angle is too small.
- Remote control battery power is low.
- Remote control is damaged or DVR front panel is damaged.

#### **21. Record storage period is not enough.**

There are following possibilities:

- Camera quality is too low. Lens is dirty. Camera is installed against the light. Camera aperture setup is not correct.
- HDD capacity is not enough.
- HDD is damaged.

#### **22. Can not playback the downloaded file.**

There are following possibilities:

- There is no media player.
- No DXB8.1 or higher graphic acceleration software.

- There is no DivX503Bundle.exe control when you play the file transformed to AVI via media player.
- No DivX503Bundle.exe or ffdshow-2004 1012 .exe in Windows XP OS.

### **23. Forget local menu operation password or network password**

Please contact your local service engineer or our sales person for help. We can guide you to solve this problem.

**Slight difference may be found in user interface.**

**All the designs and software here are subject to change without prior written notice.**

**Please visit our website for more information.**

## Appendix A HDD Capacity Calculation

Calculate total capacity needed by each DVR according to video recording (video recording type and video file storage time).

Step 1: According to Formula (1) to calculate storage capacity  $q_i$  that is the capacity of each channel needed for each hour, unit Mbyte.

$$q_i = d_i \div 8 \times 3600 \div 1024 \quad (1)$$

In the formula:  $d_i$  means the bit rate, unit Kbit/s

Step 2: After video time requirement is confirmed, according to Formula (2) to calculate the storage capacity  $m_i$ , which is storage of each channel needed unit Mbyte.

$$m_i = q_i \times h_i \times D_i \quad (2)$$

In the formula:

$h_i$  means the recording time for each day (hour)

$D_i$  means number of days for which the video shall be kept

Step 3: According to Formula (3) to calculate total capacity (accumulation)  $q_T$  that is needed for all channels in the DVR during **scheduled video recording**.

$$q_T = \sum_{i=1}^c m_i \quad (3)$$

In the formula:  $c$  means total number of channels in one DVR

Step 4: According to Formula (4) to calculate total capacity (accumulation)  $q_T$  that is needed for all channels in DVR during **alarm video recording (including motion detection)**.

$$q_T = \sum_{i=1}^c m_i \times a\% \quad (4)$$

In the formula:  $a\%$  means alarm occurrence rate

## Appendix B Compatible USB Drive List

**NOTE:** Please upgrade the DVR firmware to latest version to ensure the accuracy of the table below. If you use the USB drive, please confirm the format FAT or FAT32.

<b>Manufacturer</b>	<b>Model</b>	<b>Capacity</b>
Sandisk	Cruzer Micro	512M
Sandisk	Cruzer Micro	1G
Sandisk	Cruzer Micro	2G
Sandisk	Cruzer Freedom	256M
Sandisk	Cruzer Freedom	512M
Sandisk	Cruzer Freedom	1G
Sandisk	Cruzer Freedom	2G
Kingston	DataTraveler II	1G
Kingston	DataTraveler II	2G
Kingston	DataTraveler	1G
Kingston	DataTraveler	2G
Maxell	USB Flash Stick	128M
Maxell	USB Flash Stick	256M
Maxell	USB Flash Stick	512M
Maxell	USB Flash Stick	1G
Maxell	USB Flash Stick	2G
Kingax	Super Stick	128M
Kingax	Super Stick	256M
Kingax	Super Stick	512M
Kingax	Super Stick	1G
Kingax	Super Stick	2G
Netac	U210	128M
Netac	U210	256M
Netac	U210	512M
Netac	U210	1G
Netac	U210	2G
Teclast	Ti Cool	128M
Teclast	Ti Cool	256M
Teclast	Ti Cool	512M
Teclast	Ti Cool	1G
Teclast	Ti Cool	2G



## Appendix C Compatible CD/DVD Burner List

**NOTE:** Please upgrade the DVR firmware to latest version to ensure the accuracy of the table below. And you can use the USB cable with the model recommended to set USB burner.

<b>Manufacturer</b>	<b>Model</b>	<b>Port Mode</b>	<b>Type</b>
Sony	DRX-S50U	USB	DVD-RW
Sony	DRX-S70U	USB	DVD-RW
Sony	AW-G170S	SATA	DVD-RW
Samsung	TS-H653A	SATA	DVD-RW
Panasonic	SW-9588-C	SATA	DVD-RW
Sony	DRX-S50U	USB	DVD-RW
BenQ	5232WI	USB	DVD-RW

## Appendix D Compatible SATA HDD List

**NOTE:** Please upgrade the DVR firmware to latest version to ensure the accuracy of the table below. And SATA HDD should be used for the DVR with SATA port.

<b>Manufacturer</b>	<b>Series</b>	<b>Model</b>	<b>Capacity</b>	<b>Port Mode</b>
Seagate	Barracuda.10	ST3750640AS	750G	SATA
Seagate	Barracuda.10	ST3500630AS	500G	SATA
Seagate	Barracuda.10	ST3400620AS	400G	SATA
Seagate	Barracuda.10	ST3320620AS	320G	SATA
Seagate	Barracuda.10	ST3250620AS	250G	SATA
Seagate	Barracuda.10	ST3250820AS	250G	SATA
Seagate	Barracuda.10	ST3160815AS	160G	SATA
Seagate	Barracuda.10	ST380815AS	80G	SATA
Seagate	Barracuda.9	ST3160811AS2	160G	SATA
Seagate	Barracuda.9	ST3120811AS2	120G	SATA
Seagate	Barracuda.9	ST380811AS2	80	SATA
Seagate	Barracuda.9	ST380211AS2	80G	SATA
Seagate	Barracuda.11	ST3750330AS	750G	SATA
Seagate	Barracuda.11	ST3500320AS	500G	SATA
Maxtor	DiamondMax 20	STM3320820AS	320G	SATA
Maxtor	DiamondMax 20	STM3250820AS	250G	SATA
Maxtor	DiamondMax 21	STM3160211AS	160G	SATA
Maxtor	DiamondMax 21	STM380211AS	80G	SATA
Maxtor	DiamondMax 21	STM340211AS	40G	SATA
Western Digital	Cariar SE	WD3200JD	320G	SATA
Western Digital	Cariar SE	WD3000JD	300G	SATA
Western Digital	Cariar SE	WD2500JS	250G	SATA
Western Digital	Cariar SE	WD2000JD	200G	SATA
Western Digital	Cariar SE	WD1600JD	160G	SATA
Western Digital	Cariar SE	WD1600JS	160G	SATA
Western Digital	Cariar SE	WD1200JS	120G	SATA
Western Digital	Cariar SE	WD800JD	80G	SATA
Western Digital	Cariar	WD1600AABS2	160G	SATA
Western Digital	Cariar	WD800BD	80G	SATA
Western Digital	Cariar SE16	WD7500KS2	750G	SATA
Western Digital	Cariar SE16	WD5000KS2	500G	SATA
Western Digital	Cariar SE16	WD4000KD2	400G	SATA
Western Digital	Cariar SE16	WD3200KS2	320G	SATA
Western Digital	Cariar SE16	WD2500KS2	250G	SATA