

# GV-Mount Accessories

---

## *Installation Guide*



Before attempting to connect or operate this product, please read these instructions carefully and save this manual for future use.

MT-H



© 2014 GeoVision, Inc. All rights reserved.

Under the copyright laws, this manual may not be copied, in whole or in part, without the written consent of GeoVision.

Every effort has been made to ensure that the information in this manual is accurate. GeoVision, Inc. makes no expressed or implied warranty of any kind and assumes no responsibility for errors or omissions. No liability is assumed for incidental or consequential damages arising from the use of the information or products contained herein. Features and specifications are subject to change without notice.

GeoVision, Inc.  
9F, No. 246, Sec. 1, Neihu Rd.,  
Neihu District, Taipei, Taiwan  
Tel: +886-2-8797-8377  
Fax: +886-2-8797-8335  
<http://www.geovision.com.tw>

Trademarks used in this manual: *GeoVision*, the *GeoVision* logo and *GV* series products are trademarks of GeoVision, Inc. *Windows* and *Windows XP* are registered trademarks of Microsoft Corporation.

June 2014

# Contents

<b>Contents .....</b>	<b>i</b>
<b>Installation Overview .....</b>	<b>v</b>
GV-Mount Series.....	v
GV-Housing Series.....	viii
<b>Required Accessories .....</b>	<b>x</b>
<b>Note for Installing Camera Outdoor.....</b>	<b>xiv</b>
<b>Note for Adjusting Focus and Zoom .....</b>	<b>xv</b>
<b>Note for Supported Power Box Types .....</b>	<b>xvi</b>
<b>1. Introduction .....</b>	<b>1</b>
1.1 Accessories List .....	1
1.2 Dimensions .....	11
1.3 Packing Lists .....	19
<b>2. Installing the Vandal Proof IP Dome (Part I).....</b>	<b>30</b>
2.1 Assembling the Vandal Proof IP Dome with the dome housing .....	30
2.2 Straight Tube Box Mount.....	33
2.3 Straight Tube Mount.....	37
2.4 Wall Mount .....	40
2.5 L-Shaped Wall Mount.....	43
2.6 Wall Box Mount .....	46
2.7 Wall Pendant Mount .....	48
2.8 Convex Corner Mount with Pendant Tube .....	50
2.9 Convex Corner Mount with Wall Bracket .....	52
2.10 Convex Corner Box Mount .....	56
2.11 Concave Corner Mount with Pendant Tube .....	60
2.12 Concave Corner Mount with Wall Bracket .....	62
2.13 Pole Mount with Pendant Tube.....	65
2.14 Pole Mount with Wall Bracket .....	67
2.15 Pole Box Mount .....	70
2.16 Power Box Mount .....	73

<b>Note for Installing the Vandal Proof IP Dome .....</b>	<b>75</b>
<b>3. Installing the Vandal Proof IP Dome (Part II).....</b>	<b>76</b>
3.1 Straight Tube Box Mount.....	76
3.2 Straight Tube Mount.....	80
3.3 Wall Mount .....	83
3.4 L-Shaped Wall Mount.....	86
3.5 Wall Box Mount .....	89
3.6 Wall Pendant Mount.....	91
3.7 Convex Corner Mount with Pendant Tube .....	94
3.8 Convex Corner Mount with Wall Bracket .....	97
3.9 Convex Corner Box Mount .....	100
3.10 Concave Corner Mount with Pendant Tube .....	104
3.11 Concave Corner Mount with Wall Bracket .....	107
3.12 Pole Mount with Pendant Tube.....	110
3.13 Pole Mount with Wall Bracket.....	113
3.14 Pole Box Mount .....	116
3.15 Power Box Mount .....	120
<b>4. Installing the Fixed IP Dome.....</b>	<b>122</b>
4.1 Basic Installation .....	122
4.1.1 Assembling the Fixed IP Dome with the Dome Housing.....	122
4.1.2 Putting on the Housing Cover.....	124
4.2 Straight Tube Box Mount.....	125
4.3 Straight Tube Mount.....	129
4.4 Wall Mount .....	132
4.5 L-Shaped Wall Mount.....	135
4.6 Wall Box Mount .....	138
4.7 Wall Pendant Mount.....	140
4.8 Convex Corner Mount .....	142
4.9 Convex Corner Box Mount .....	144
4.10 Concave Corner Mount .....	148
4.11 Pole Mount .....	150
4.12 Pole Box Mount .....	152
4.13 Power Box Mount .....	155
<b>5. Installing the Fisheye Camera.....</b>	<b>157</b>
5.1 Assembling the Fisheye Camera with the Dome Housing.....	157



















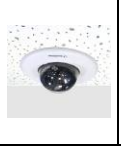

5.2	Straight Tube Box Mount .....	159
5.3	Straight Tube Mount .....	163
5.4	Wall Mount .....	165
5.5	Wall Pendant Mount .....	168
5.6	Tilting Wall Mount .....	169
5.7	Convex Corner Mount .....	172
5.8	Convex Corner Box Mount .....	174
5.9	Concave Corner Mount .....	177
5.10	Pole Mount .....	179
5.11	Pole Box Mount .....	181
5.12	Power Box Mount .....	184
<b>6.</b>	<b>Installing the GV-SD220/220-S IP Speed Dome.....</b>	<b>186</b>
6.1	Assembling GV-SD220-S with Pendant Tube.....	186
6.2	GV-SD220 In-Ceiling Mount .....	188
6.3	GV-SD220-S In-Ceiling Mount.....	192
6.4	Straight Tube Box Mount .....	195
6.5	Straight Tube Mount .....	198
6.6	Convex Corner Mount .....	201
6.7	Convex Corner Box Mount .....	202
6.8	Convex Corner Mount .....	205
6.9	Pole Mount .....	206
6.10	Pole Box Mount .....	207
	<b>Note for Closing the Bullet Camera Cover .....</b>	<b>209</b>
<b>7.</b>	<b>Installing the Bullet Camera .....</b>	<b>210</b>
7.1	Convex Corner Mount .....	210
7.2	Concave Corner Mount .....	212
7.3	Pole Mount .....	214
	<b>Note for Installing the Box Camera.....</b>	<b>216</b>
<b>8.</b>	<b>Installing the Box Camera .....</b>	<b>217</b>
8.1	Assembling Box Camera with Housing Box.....	217
8.2	Convex Corner Mount .....	222
8.3	Concave Corner Mount .....	224
8.4	Pole Mount .....	226

<b>9. Installing the Arctic Box Camera .....</b>	<b>228</b>
9.1 Convex Corner Mount .....	228
9.2 Concave Corner Mount .....	230
9.3 Pole Mount .....	232
<b>10. Installing the Mini Fixed Dome .....</b>	<b>234</b>
10.1 L-Shaped Wall Mount .....	234
10.2 Wall Box Mount .....	236
10.3 Power Box Mount .....	238
<b>11. Installing the Mini Fixed Rugged Dome .....</b>	<b>240</b>
11.1 L-Shaped Wall Mount .....	240
11.2 Wall Box Mount .....	243
11.3 Power Box Mount .....	245
<b>12. Installing the Target Mini Fixed Dome .....</b>	<b>248</b>
12.1 L-Shaped Wall Mount .....	248
12.2 Wall Box Mount .....	251
12.3 Power Box Mount .....	253

















# Installation Overview

## GV-Mount Series

















The GV-Mount Series supports installation of Vandal Proof IP Dome, Fixed IP Dome, Fisheye Camera, IP Speed Dome (GV-SD220/220-S), Bullet Camera, Arctic Box Camera, Mini Fixed Dome, Mini Fixed Rugged Dome and Target Mini Fixed Dome on various environments, such as the ceiling, wall surface, wall corner and pole. The supported installation types are illustrated below.





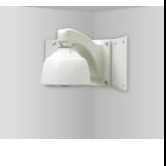

















	GV-VD Series	GV-FD Series	GV-FE Series	GV-SD220 GV-SD220-S	GV-BL Series	GV-BX-E Series	GV-MFD Series	GV-MDR Series	GV-EFD1100
<b>Standard Installation</b>									
<b>Ceiling</b>	<b>Hard Ceiling</b>								
				 *GV-SD220 only					
	<b>In-Ceiling</b>								
									
<b>Wall</b>	<b>Wall Mount</b>			<b>Wall Pendant</b>	<b>Wall Mount</b>				
				 *GV-SD220-S only					
<b>Ground</b>	<b>Ground Mount</b>								
									
<b>Power Box</b>	<b>Power Box Mount</b>								
									

**Note:** In-ceiling mount is not supported for the following GV-VD models: GV-VD1530 / 1540 / 1540-E / 2430 / 2440 / 2440-E / 2530 / 2540 / 2540-E / 3430 / 3440 / 3440-E / 5340 / 5340-E.

	GV-VD Series	GV-FD Series	GV-FE Series	GV-SD220 or GV-SD220-S	GV-BL Series	GV-BX-E Series
<b>Optional Installation</b>						
<b>Ceiling</b>	<b>In-Ceiling Mount</b>					
				 <p>*GV-SD220 only</p>		
				 <p>*GV-SD220-S only</p>		
	<b>Straight Tube</b>					
				 <p>*GV-SD220-S only</p>		
	<b>Straight Tube Box</b>					
			 <p>*GV-SD220-S only</p>			
<b>Pole</b>	<b>Pole Mount</b>					
				 <p>*GV-SD220-S only</p>		
						
	<b>Pole Box Mount</b>					
			 <p>*GV-SD220-S only</p>			







	GV-VD Series	GV-FD Series	GV-FE Series	GV-SD220 or GV-SD220-S	GV-BL Series	GV-BX-E Series
<b>Optional Installation</b>						
<b>Corner</b>	<b>Convex Corner Mount</b>					
						
				*GV-SD220-S only		
	<b>Convex Corner Box Mount</b>					
						
			*GV-SD220-S only			
<b>Corner</b>	<b>Concave Corner Mount</b>					
						
				*GV-SD220-S only		

	GV-VD Series	GV-FD Series	GV-FE Series	GV-MFD Series	GV-MDR Series	GV-EFD 1100
<b>Optional Installation</b>						
<b>Wall</b>	<b>Wall Mount Bracket</b>					
						
	<b>L-Shaped Wall Mount</b>		<b>Tilting Wall Mount</b>	<b>L-Shaped Wall Mount</b>		
						
	<b>Wall Pendant Mount</b>					
						
	<b>Wall Box Mount</b>					
						
<b>Power Box</b>	<b>Power Box Mount</b>					
						

## GV-Housing Series

The GV-Housing Series supports outdoor or indoor installation of GV-BX Series with external protection. The supported installation types are illustrated below. For the supported GV-BX models, refer to *Note for Installing Box Camera* later in this installation guide.

GV-BX Series	
<b>Standard Installation</b>	
Housing Box	
<b>Optional Installation</b>	
Housing Box	<b>Convex Corner Mount</b>
	
	<b>Concave Corner Mount</b>
	
	<b>Pole Mount</b>
	

# Required Accessories

Look up the required accessories for each installation method from the table below. For more information, contact your local dealer.

## IMPORTANT:

1. GV-VD Series (I) refers to the following models: GV-VD120D / 121D / 122D / 123D / 220D / 221D / 222D / 223D / 320D / 321D / 322D / 323D / 1500 / 2400 / 2500 / 3400; GV-VD Series (II) refers to the following models: GV-VD1530 / 1540 / 1540-E / 2430 / 2440 / 2440-E / 2530 / 2540 / 2540-E / 3430 / 3440 / 3440-E / 5340 / 5340-E
2. For **Straight Tube Box Mount**, **Convex Corner Box Mount**, **Concave Corner Box Mount** and **Pole Box Mount**, a user-prepared corrugated tube of 3/4", ø 26.0 ~ 26.5 mm is required. For example,



3. To extend the tube for **Straight Tube Box Mount** and **Straight Tube Mount**, purchase a GV-Mount702.

Optional Installation Method		Required Accessories
<b>Ceiling Mount</b>		
Straight Tube Box Mount	GV-FD Series	GV-Mount100 + GV-Mount902
	GV-FE Series	GV-Mount100 + GV-Mount903
	GV-SD220-S	GV-Mount100
	GV-VD Series (I)	GV-Mount100 + GV-Mount901
	GV-VD Series (II)	GV-Mount100 + GV-Mount903
Straight Tube Mount	GV-FD Series	GV-Mount101 + GV-Mount902
	GV-FE Series	GV-Mount101 + GV-Mount903
	GV-SD220-S	GV-Mount101
	GV-VD Series (I)	GV-Mount101 + GV-Mount901
	GV-VD Series (II)	GV-Mount101 + GV-Mount903
In-Ceiling Mount	GV-SD220	GV-Mount907
	GV-SD220-S	GV-Mount908

Optional Installation Method		Required Accessories	
<b>Corner Mount</b>			
Convex Corner Mount		GV-BL Series	GV-Mount300
		GV-BX Series	GV-Mount300 + GV-Housing101
		GV-BX-E Series	GV-Mount300
		GV-FD Series	GV-Mount300 + GV-Mount200 + GV-Mount902
		GV-FE Series	GV-Mount300 + GV-Mount200 + GV-Mount903
		GV-SD220-S	GV-Mount300 + GV-Mount200
		GV-VD Series (I)	GV-Mount300 + GV-Mount900
			GV-Mount300 + GV-Mount200 + GV-Mount901
	GV-VD Series (II)	GV-Mount300 + GV-Mount900	
		GV-Mount300 + GV-Mount200 + GV-Mount903	
Convex Corner Box Mount		GV-FD Series	GV-Mount300 + GV-Mount203 + GV-Mount902
		GV-FE Series	GV-Mount300 + GV-Mount203 + GV-Mount903
		GV-SD220-S	GV-Mount300 + GV-Mount203
		GV-VD Series (I)	GV-Mount300 + GV-Mount203 + GV-Mount901
		GV-VD Series (II)	GV-Mount300 + GV-Mount203 + GV-Mount903
Concave Corner Mount		GV-BL Series	GV-Mount310
		GV-BX Series	GV-Mount310 + GV-Housing101
		GV-BX-E Series	GV-Mount310
		GV-FD Series	GV-Mount310 + GV-Mount200 + GV-Mount902
		GV-FE Series	GV-Mount310 + GV-Mount200 + GV-Mount903
		GV-SD220-S	GV-Mount310 + GV-Mount200
		GV-VD Series (I)	GV-Mount310 + GV-Mount900
			GV-Mount310 + GV-Mount200 + GV-Mount901
		GV-VD Series (II)	GV-Mount310 + GV-Mount900
	GV-Mount310 + GV-Mount200 + GV-Mount903		
<b>Pole Mount</b>			
Pole Mount	Ø 4" ~ 6"	GV-BL Series	GV-Mount400
		GV-BX Series	GV-Mount400 + GV-Housing101
		GV-BX-E Series	GV-Mount400
		GV-FD Series	GV-Mount400 + GV-Mount200 + GV-Mount902
		GV-FE Series	GV-Mount400 + GV-Mount200 + GV-Mount903
		GV-SD220-S	GV-Mount400 + GV-Mount200
		GV-VD Series (I)	GV-Mount400 + GV-Mount900
			GV-Mount400 + GV-Mount200 + GV-Mount901
		GV-VD Series (II)	GV-Mount400 + GV-Mount900
GV-Mount400 + GV-Mount200 + GV-Mount903			

Optional Installation Method		Required Accessories	
<b>Pole Mount</b>			
Pole Mount	Ø 6" ~ 7.5"	GV-BL Series	GV-Mount410
		GV-BX Series	GV-Mount410 + GV-Housing101
		GV-BX-E Series	GV-Mount410
		GV-FD Series	GV-Mount410 + GV-Mount200 + GV-Mount902
		GV-FE Series	GV-Mount410 + GV-Mount200 + GV-Mount903
		GV-SD220-S	GV-Mount410 + GV-Mount200
		GV-VD Series (I)	GV-Mount410 +GV-Mount900
			GV-Mount410 + GV-Mount200 + GV-Mount901
GV-VD Series (II)	GV-Mount410 +GV-Mount900		
	GV-Mount410 + GV-Mount200 + GV-Mount903		
Pole Box Mount	Ø 4" ~ 6"	GV-FD Series	GV-Mount400 + GV-Mount203 + GV-Mount902
		GV-FE Series	GV-Mount400 + GV-Mount203 + GV-Mount903
		GV-SD220-S	GV-Mount400 + GV-Mount203
		GV-VD Series (I)	GV-Mount400 + GV-Mount203 + GV-Mount901
		GV-VD Series (II)	GV-Mount400 + GV-Mount203 + GV-Mount903
	Ø 6" ~ 7.5"	GV-FD Series	GV-Mount410 + GV-Mount203 + GV-Mount902
		GV-FE Series	GV-Mount410 + GV-Mount203 + GV-Mount903
		GV-SD220-S	GV-Mount410 + GV-Mount203
		GV-VD Series (I)	GV-Mount410 + GV-Mount203 + GV-Mount901
		GV-VD Series (II)	GV-Mount410 + GV-Mount203 + GV-Mount903
<b>Wall Mount</b>			
Wall Mount Bracket	GV-FD Series	GV-Mount205	
	GV-FE Series	GV-Mount205	
	GV-VD Series (I) GV-VD Series (II)	GV-Mount205	
L-Shaped Wall Mount	GV-FD Series	GV-Mount900	
	GV-MFD Series	GV-Mount900	
	GV-MDR Series	GV-Mount900	
	GV-EFD1100	GV-Mount900	
	GV-VD Series (I) GV-VD Series (II)	GV-Mount900	
Wall Box Mount	GV-FD Series	GV-Mount909	
	GV-MFD Series	GV-Mount909	
	GV-MDR Series	GV-Mount909	
	GV-EFD1100	GV-Mount909	
	GV-VD Series (I) GV-VD Series (II)	GV-Mount909	

Optional Installation Method		Required Accessories
<b>Wall Mount</b>		
Wall Pendant Mount	GV-FD Series	GV-Mount200 + GV-Mount902
	GV-FE Series	GV-Mount200 + GV-Mount903
	GV-VD Series (I)	GV-Mount200 + GV-Mount901
	GV-VD Series (II)	GV-Mount200 + GV-Mount903
Tilting Wall Mount	GV-FE Series	GV-Mount904
<b>Power Box Mount</b>		
Power Box Mount	GV-FE Series GV-FER521	GV-Mount912
	GV-FD Series	GV-Mount913
	GV-MDR Series	GV-Mount910 or GV-Mount913
	GV-MFD Series	GV-Mount910 or GV-Mount913
	GV-EFD1100	GV-Mount910 or GV-Mount913
	GV-VD Series (I)	N/A
	GV-VD Series (II)	N/A

## Note for Installing Camera Outdoor

When installing the camera outdoor, be sure that:

1. The camera is set up above the junction box to prevent water from entering the camera along the cables.

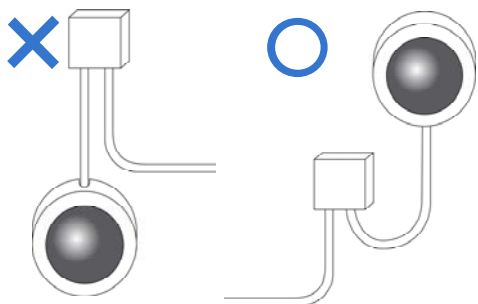

2. Any network, power, audio and I/O cables are waterproofed using waterproof silicon rubber or the like.

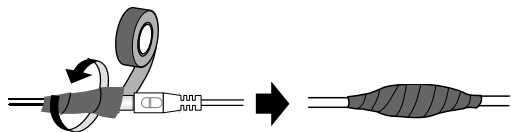

3. To prevent the lens from fogging up, ensure to replace the silica gel bag/desiccant pack every time you open the camera, and conceal the gel bag/desiccant pack in the camera within 2 minutes of exposing to open air. The silica gel bag/desiccant loses its effectiveness when the dry camera is opened.
4. For each newly replaced silica gel bag, allow it to absorb moisture for at least 5 hours before operating the camera.
5. After opening the camera cover, ensure the screws are tightened and the cover is in place.

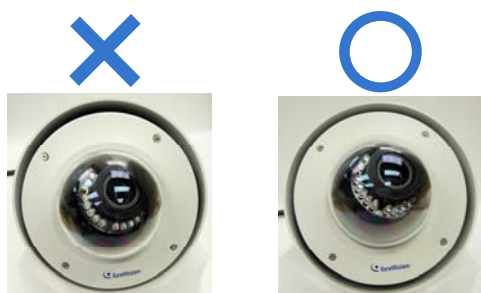



# Note for Adjusting Focus and Zoom

When adjusting the Focus and Zoom Screws (on Bullet Camera, Vandal Proof IP Dome and Fixed IP Camera), do not over tighten the Focus and Zoom screws. The screws only need to be as tight as your finger can do it. It is not necessary to use any tools to get them tighter. Doing so can damage the structure of lens.

For example,

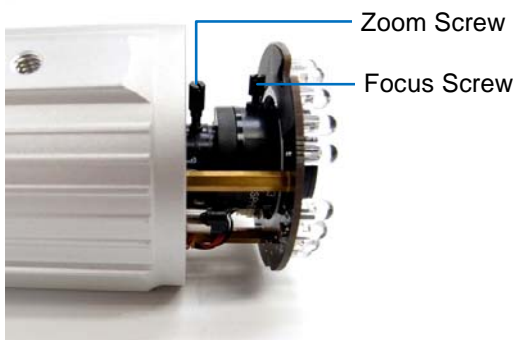

**Bullet Camera**



**Fixed IP Camera**

The maximum torque value for all the zoom and focus screws is 0.049 N.m

# Note for Supported Power Box Types

The supported power box types and required accessory are detailed below:



Camera Type	Required Accessory	Supported Power Box Type			
		Single Gang	Double Gang	4" Octagon	4" Square
GV-FE Series GV-FER521	GV-Mount912	✓	✓	✓	✓
GV-FD Series	GV-Mount913	✓	✓	✓	✓
GV-MDR Series GV-MFD Series GV-EFD1100	GV-Mount910	✓	✓	✓	
	GV-Mount913	✓	✓	✓	✓
GV-VD Series	N/A		✓		✓





For the Power Box Mount, see the related sections in *Chapter 2 and 3* for GV-VD Series, *Chapter 4* for GV-FD Series, *Chapter 5* for GV-Fisheye Series, *Chapter 9* for GV-MFD Series, *Chapter 10* for GV-MDR Series, and *Chapter 11* for GV-EFD1100.



# 1. Introduction



## 1.1 Accessories List

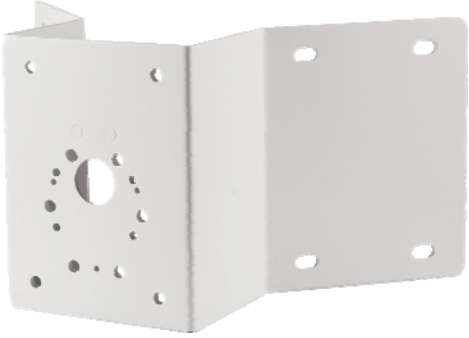
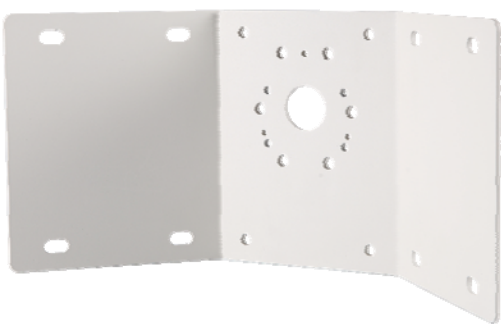

Model No.	Name	Details
GV-Mount100	<b>Straight Tube and Junction Box Kit</b> 	<b>Dimensions</b> 200 x 170 x 257.5 mm / 7.9 x 6.7 x 10.1 in
		<b>Weight</b> 3.17 kg / 6.99 lb
		<b>Supplied with</b> M5 flat screw (15 mm) x 4 Corrugated tube connector x 1 No.2 torx wrench x 1
GV-Mount101	<b>Straight Tube Kit</b> 	<b>Dimensions</b> 219 x 125 x 332 mm / 8.6 x 4.9 x 13.1 in
		<b>Weight</b> 1.8 kg / 3.97 lb
		<b>Supplied with</b> No.2 torx wrench x 1
GV-Mount200	<b>Wall Pendant Tube</b> 	<b>Dimensions (L x W x D)</b> 200 x 140 x 249 mm / 7.9 x 5.5 x 9.8 in
		<b>Weight:</b> 0.93 kg / 2.05 lb

Model No.	Name	Details
<b>GV-Mount203</b>	<b>Wall Pendant Tube and Junction Box Kit</b> 	<b>Dimensions</b> 315 x 195.5 x 225 mm / 12.4 x 7.7 x 8.9 in
		<b>Weight</b> 2.95 kg / 6.5 lb
		<b>Supplied with</b> M5 screw (25 mm) x 2 Corrugated tube connector x 1 No.5 Torx Wrench x 1
<b>GV-Mount205</b>	<b>Wall Mount Bracket Kit</b> 	<b>Dimensions</b> 126.5 x 203 x 160 mm / 5 x 8 x 6.3 in (L x W x diameter)
		<b>Weight</b> 0.5 kg / 1.1 lb
		<b>Supplied with</b> M4 screw (8 mm) x 15 M4 screw (40 mm) x 4 Screw anchor x 4 M4.5 plain washer x 4 M4 split washer x 4

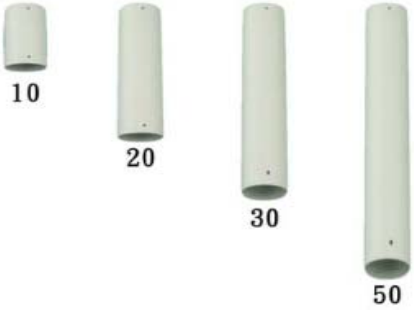

Model No.	Name	Details
GV-Mount300	<b>Convex Corner Adapter Kit</b> 	<p><b>Dimensions</b> 238.6 x 409.5 mm / 9.4 x 16.1 in</p> <p><b>Weight</b> 4.27 kg / 9.41 lb</p> <p><b>Option 1 supplied with:</b> M8 screw (30 mm) x 4 M8 screw cap x 6 M8 split washer x 6 M8 plain washer x 6 M5 screw (20 mm) x 4 M5 screw cap x 4 M5 split washer x 4 M5 plain washer x 4</p> <p><b>Option 2 supplied with (for assembling with Mount203):</b> M8 screw (25 mm) x 4 M8 screw cap x 6 M8 split washer x 6 M8 plain washer x 6 M5 screw (25 mm) x 2 M5 screw (20 mm) x 4 M5 screw cap x 4 M5 split washer x 4 M5 plain washer x 4</p>
GV-Mount310	<b>Concave Corner Adapter Kit</b> 	<p><b>Dimensions</b> 123.3 x 393.1 mm / 4.9 x 15.5 in</p> <p><b>Weight</b> 2.96 kg / 6.53 lb</p> <p><b>Supplied with</b> M8 screw (30 mm) x 4 M8 screw cap x 6 M8 split washer x 6 M8 plain washer x 6 M5 screw (20 mm) x 4 M5 screw cap x 4 M5 split washer x 4 M5 plain washer x 4</p>



Model No.	Name	Details
GV-Mount400	<b>Pole Mount Bracket Kit (Ø 4" ~ 6")</b> 	<p><b>Dimensions (Bracket)</b> Bracket: 241 x 161 mm / 9.5 x 6.3</p> <p><b>Steel Strap Diameter</b> Ø 4" ~ 6"</p> <p><b>Weight</b> 1.70 kg / 3.75 lb</p> <p><b>Supplied with</b> Stainless steel strap (Ø 4" ~ 6") x 3 M8 screw (30 mm) x 4 M8 screw (25 mm) x 4 M8 screw cap x 4 M8 split washer x 4 M8 plain washer x 4 M5 screw (20 mm) x 4 M5 screw cap x 4 M5 split washer x 4 M5 plain washer x 4</p>
GV-Mount410	<b>Pole Mount Bracket Kit (Ø 6" ~ 7.5")</b> 	<p><b>Dimensions (Bracket)</b> 241 x 161 mm / 9.5 x 6.3 in</p> <p><b>Steel Strap Diameter</b> Ø 6" ~ 7.5"</p> <p><b>Weight</b> 1.70 kg / 3.75 lb</p> <p><b>Supplied with</b> Stainless steel strap (Ø 6" ~ 7.5") x 3 M8 screw (30 mm) x 4 M8 screw (25 mm) x 4 M8 screw cap x 4 M8 split washer x 4 M8 plain washer x 4 M5 screw (20 mm) x 4 M5 screw cap x 4 M5 split washer x 4 M5 plain washer x 4</p>

Model No.	Name	Details	
GV-Mount702	<p><b>Extension Tube</b></p> 	<p><b>Four options are available.</b></p> <hr/> <p><b>Dimensions</b>            Ø 5.4 x 10 or 20 or 30 or 50 cm            Ø 2.1 x 3.9 / 7.9 / 11.8 / 19.7 in</p> <hr/> <p><b>Weight</b>            180 g / 0.4 lb            390 g / 0.86 lb            550 g / 1.21lb            800 g / 1.76 lb</p>	
	GV-Mount900	<p><b>Wall Mount Bracket</b></p> 	<p><b>Supplied with</b>            Extension tube connector x 1</p> <hr/> <p><b>Supplied with</b>            Screw anchor x 4            Wall mount screw x 4            M3 screw (8 mm) x 4            M5 screw (10 mm) x 6</p>
		GV-Mount901	<p><b>Dome Housing</b></p> 



Model No.	Name	Details
GV-Mount902	<b>GV-FD Series Dome Housing</b> 	<p><b>Dimensions</b>            ø 186 x 165.35 mm / ø 7.3 x 6.51 in</p> <p><b>Weight</b>            700 g / 1.54 lb</p> <p><b>Supplied with</b>            Left &amp; right rack x 1 (pair)            Housing plate x 1            Small screw x 3            M4 screw x 4            M6 screw x 7</p>
GV-Mount903	<b>Dome Housing</b> 	<p><b>Dimensions</b>            ø 185.51 x 165.35 mm / 7.3 x 6.51 in</p> <p><b>Weight</b>            714 g / 1.57 lb</p> <p><b>Supplied with</b>            M4 screw x 4            M6 screw x 7</p>

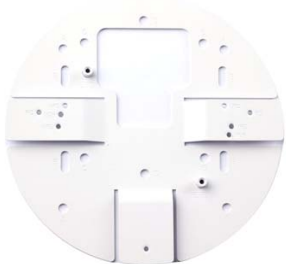

Model No.	Name	Details
GV-Mount904	<p><b>Tilting Wall Mount Bracket</b></p> 	<p><b>Dimensions</b>            Ø 159.1 x 40.5 mm /            Ø 6.3 x 1.6 in</p> <p><b>Tilt angle:</b> 0-20°</p> <p><b>Supplied with</b>            Back cover x 1            Back plate x 1            Tilting rack x 1            Long screw x 3            Short screw x 9            Installation sticker x 1</p>
GV-Mount907	<p><b>In-Ceiling Mounting Kit for GV-SD220 IP Speed Dome</b></p> 	<p><b>Dimensions</b>            Ø 230 x 153.49 mm /            Ø 9.08 x 6.05 in</p> <p><b>Weight</b>            0.87 kg / 1.91 lb</p> <p><b>Supplied with</b>            In-ceiling cover x 1            Mounting ring x 1            Mounting plate x 1            Support rack x 3            Screw x 9            Thread lock &amp; screw x 1 set            Lock plate &amp; screw x 1 set            Hex key x 1</p>

Model No.	Name	Details
<b>GV-Mount908</b>	<b>In-Ceiling Mounting Kit for GV-SD220-S IP Speed Dome</b>  	<b>Dimensions</b> Mounting plate: 227 x 286 mm / 8.9" x 11.3"
		<b>Weight</b> 2.05 kg / 4.5 lb
		<b>Supplied with</b> Screw x 4 Hex key x 1 M6 screw x 4 Installation sticker x 1 M4 screw x 2 In-ceiling cover x 1
<b>GV-Mount909</b>	<b>Wall Mount Bracket</b>  	<b>Dimensions</b> 170 x 150 x 110 mm / 6.7" x 5.9" x 4.3"
		<b>Weight</b> 610 g / 1.34 lb
		<b>Supplied with</b> Screw anchor x 4 Wall mount screw x 4 M3 screw (8 mm) x 4 M5 screw x 6
<b>GV-Mount910</b>	<b>Power Box Mount Bracket</b>  	<b>Dimensions</b> 112 x 98 x 7.5 mm / 4.4" x 3.9" x 0.3"
		<b>Weight</b> 105 g / 0.23 lb
		<b>Supplied with</b> M3 screw (8 mm) x 4

Model No.	Name	Details
<b>GV-Mount912</b>	<b>Power Box Mount Bracket</b> 	<b>Dimensions</b> Ø146 x 10.5 mm / 5.7" x 0.4"
		<b>Weight</b> 180 g / 0.4 lb
		<b>Supplied with</b> M3 screw (8 mm) x 4
<b>GV-Mount913</b>	<b>Power Box Mount Bracket</b> 	<b>Dimensions</b> Ø146 x 7.5 mm / 5.7" x 0.3"
		<b>Weight</b> 180 g / 0.4 lb
		<b>Supplied with</b> M3 screw (8 mm) x 4

Model No.	Name	Details
<b>GV-Housing101</b>	<b>Housing Box</b> 	<p><b>Dimensions</b> 406 x 145 x 109 mm / 16" x 5.7" x 4.3"</p> <p><b>Weight</b> 4.69 kg / 10.34 lb (including Supporting Tube)</p> <p><b>Operation</b> Ingress Protection (IP67) Vandal Resistance (IK10) Start-up Temperature: -30°C ~ 50°C / -22°F ~ 122°F Operation Temperature: -40°C ~ 50°C / -40°F ~ 122°F Heater: 15°C On / 25°C Off Fan: 35°C On / 25°C Off Power Board: 24V AC / 12V DC input</p> <p><b>Supplied with</b> M5 Screw (35 mm) x 4 Short screw x 1 Screw anchor x 4 M5 Plain washer (7 mm) x 4 M5 Plain washer (16 mm) x 1 Torx wrench x 1 Black plate x 1 Supporting Tube x 1 Silica gel bag x 1 Sticker (for silica gel bag) x 1</p>
<b>GV-PA191</b>	<b>Power over Ethernet (PoE) Adapter</b> 	<p>The GV-PA191 is a Power over Ethernet (PoE) adapter designed to provide power to the IP device through a single Ethernet cable.</p> <p>For details, see <a href="http://www.geovision.com.tw/english/Prod_GVPA191.asp">http://www.geovision.com.tw/english/Prod_GVPA191.asp</a></p>

## 1.2 Dimensions

- **GV-Mount100**

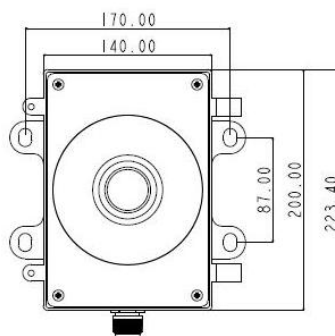
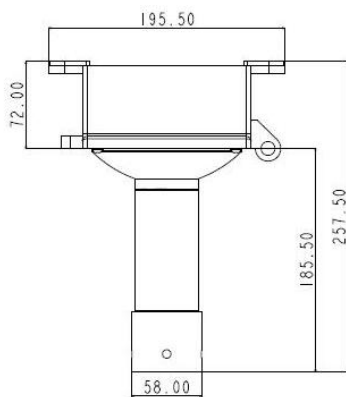
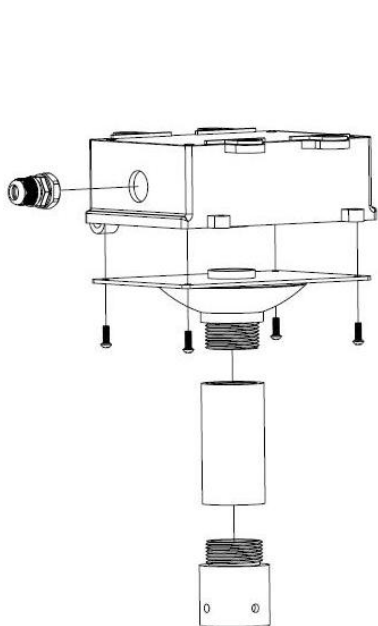

- **GV-Mount101**

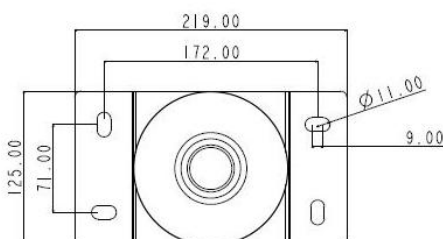
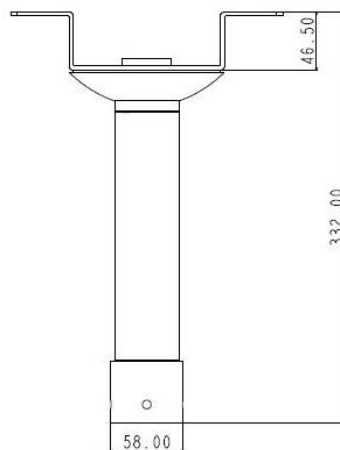
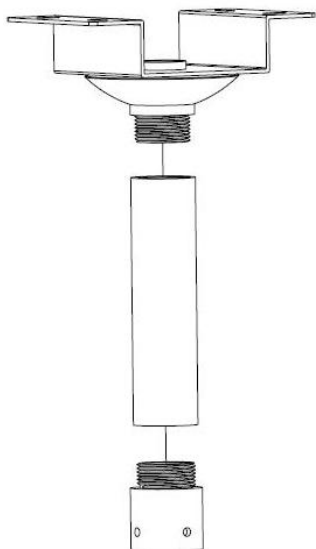

- **GV-Mount200**

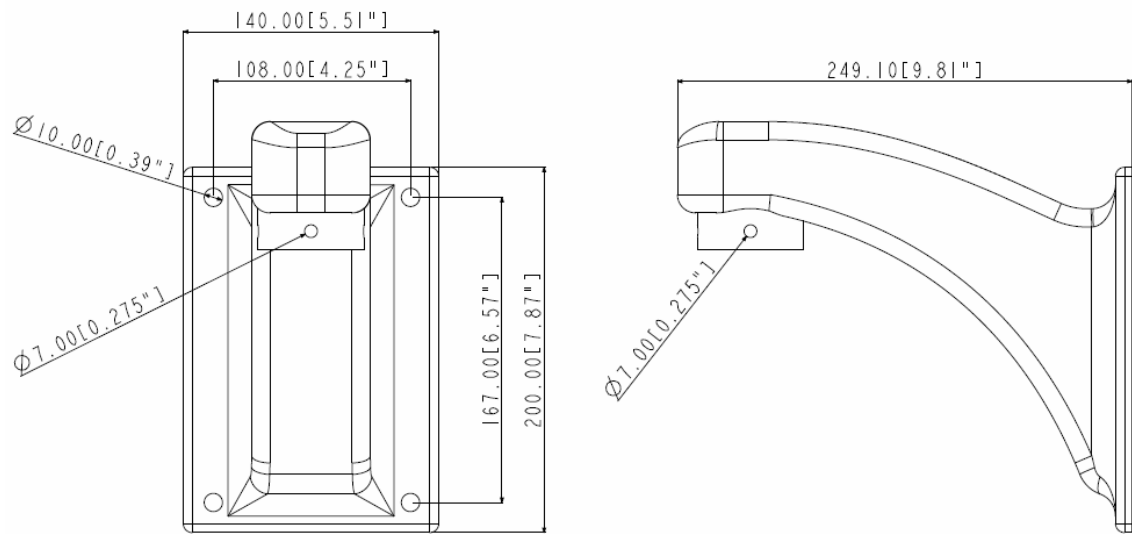

- **GV-Mount203**

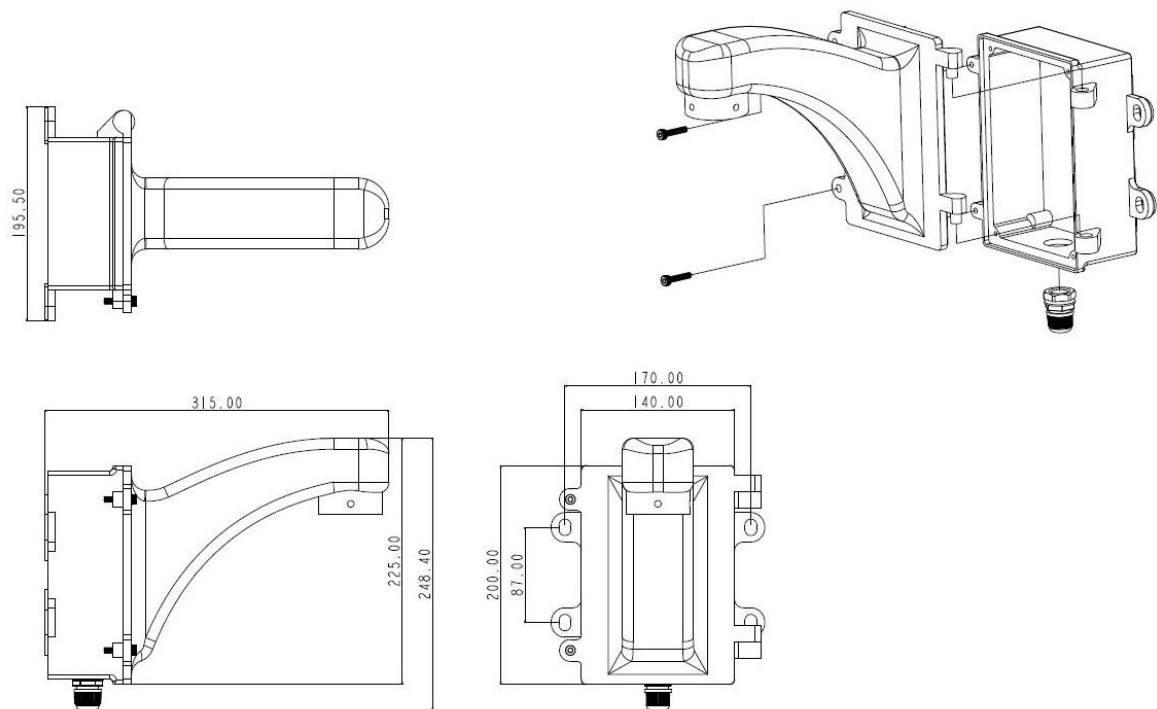

• **GV-Mount205**

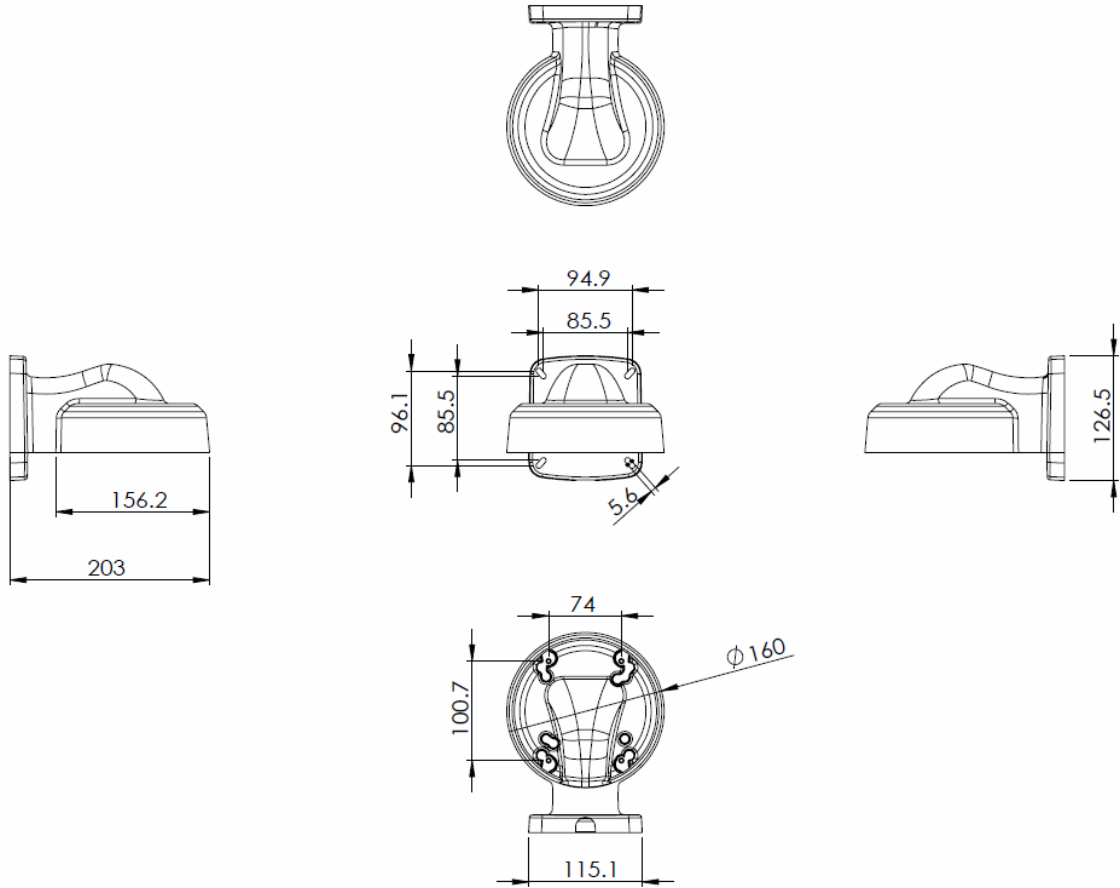

• **GV-Mount300**

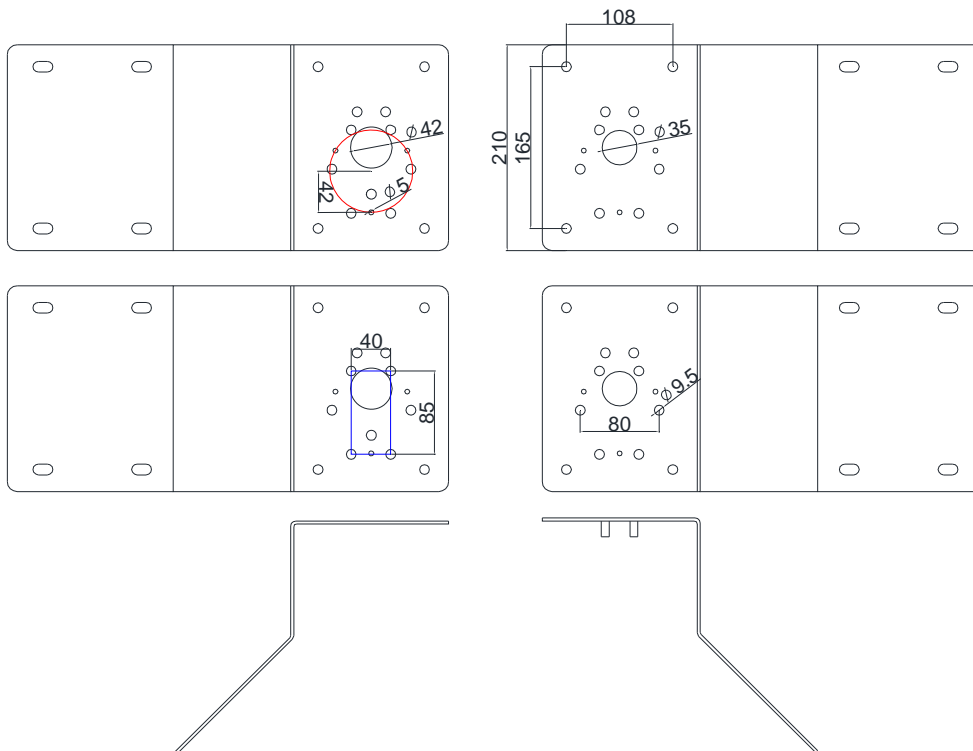

• **GV-Mount310**

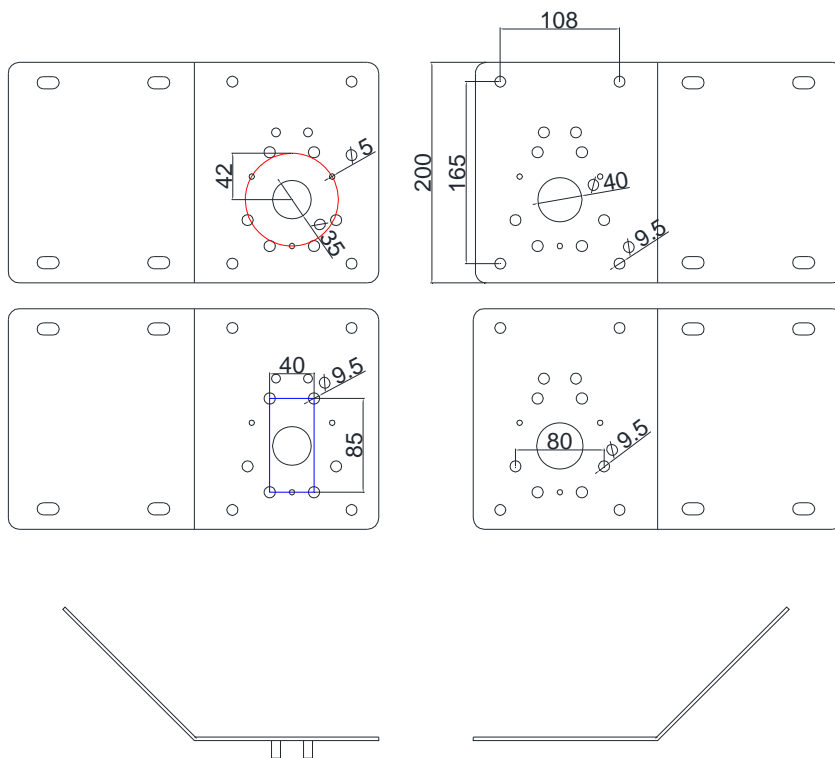

• **GV-Mount400 /Mount410**

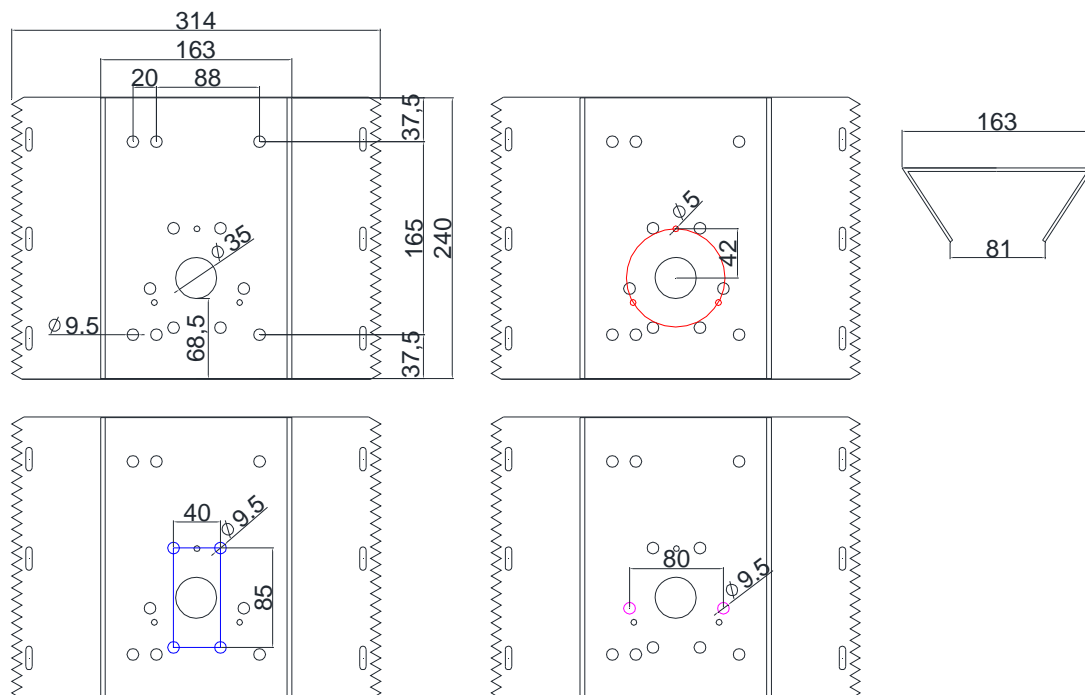



- **GV-Mount901 / Mount902 / Mount903**

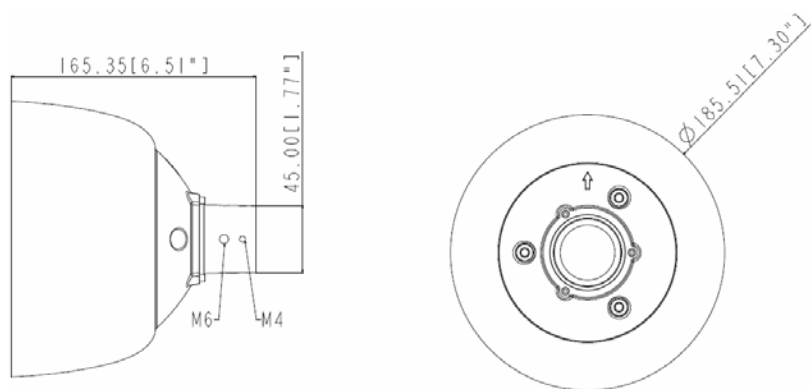

- **GV-Mount908**

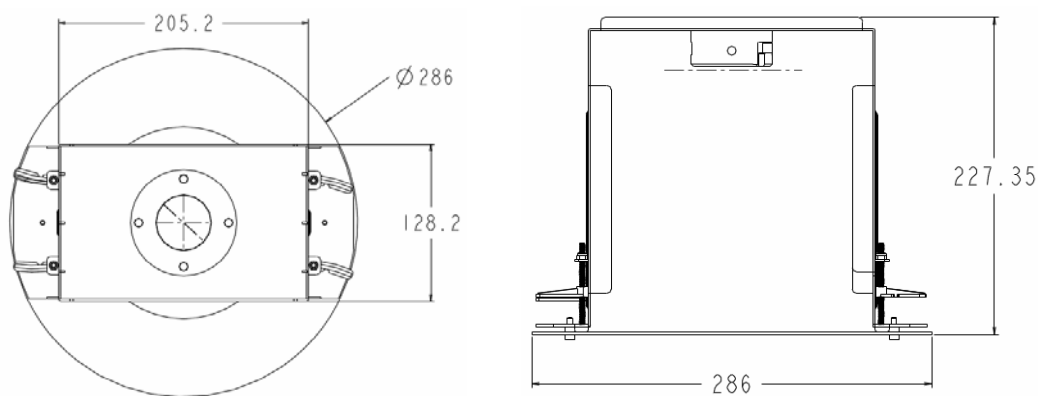

- **GV-Mount909**

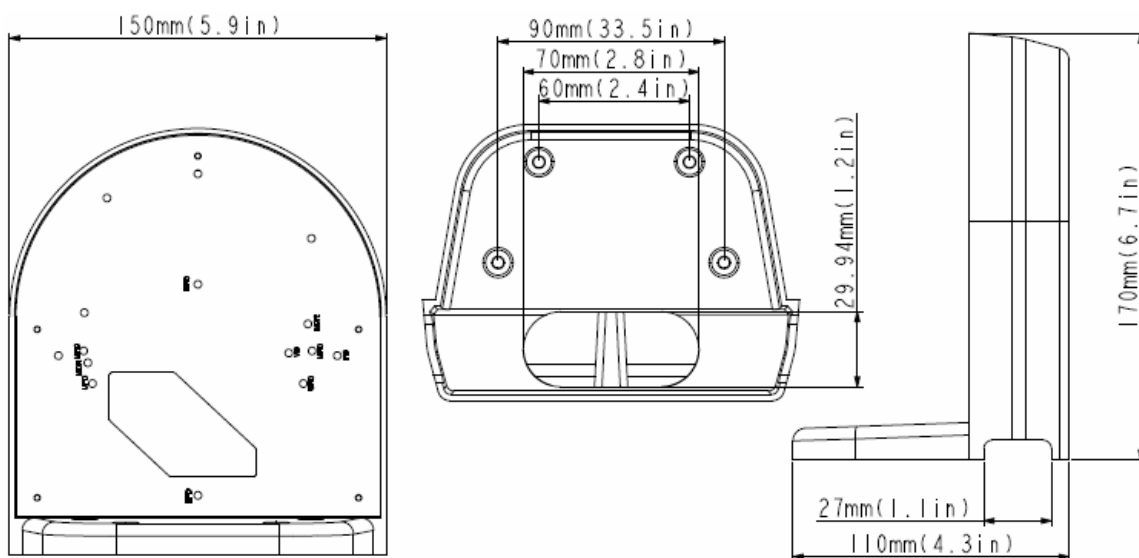

- **GV-Mount910**

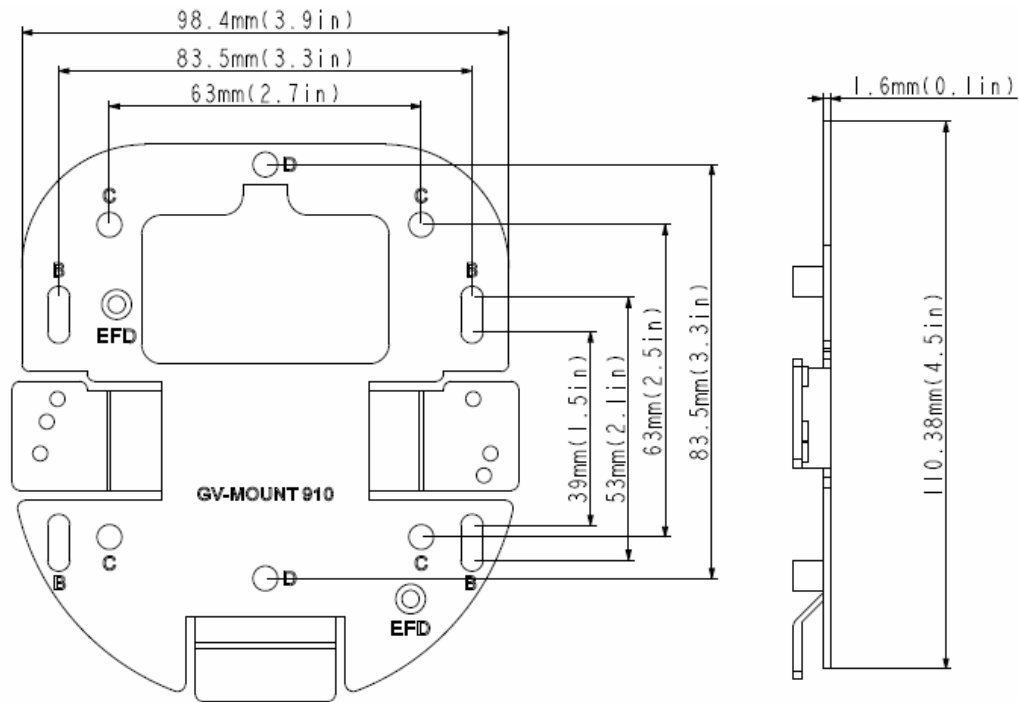

- **GV-Mount912**

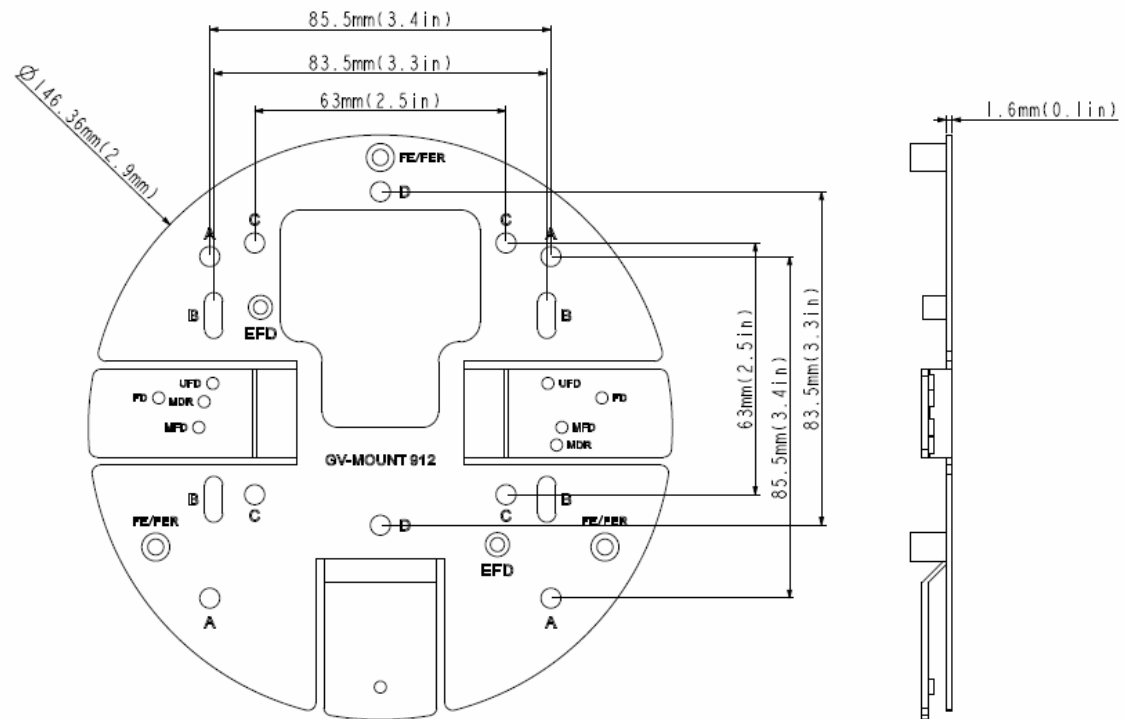

- **GV-Mount913**

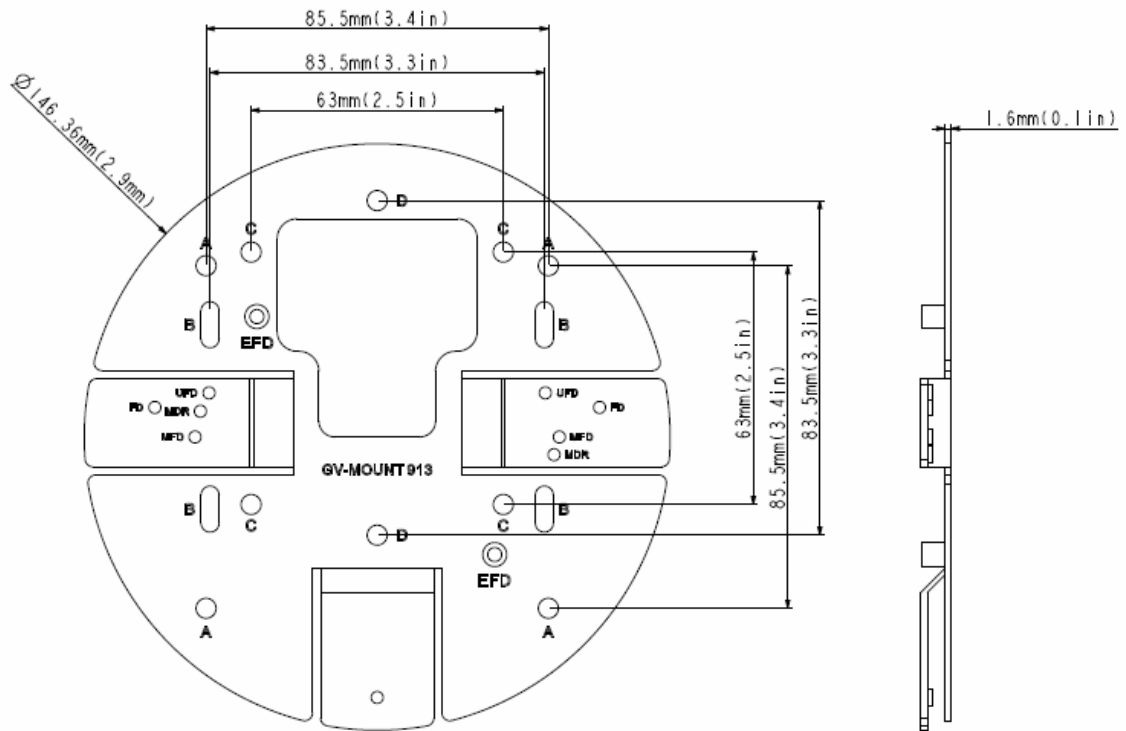

- GV-Housing101

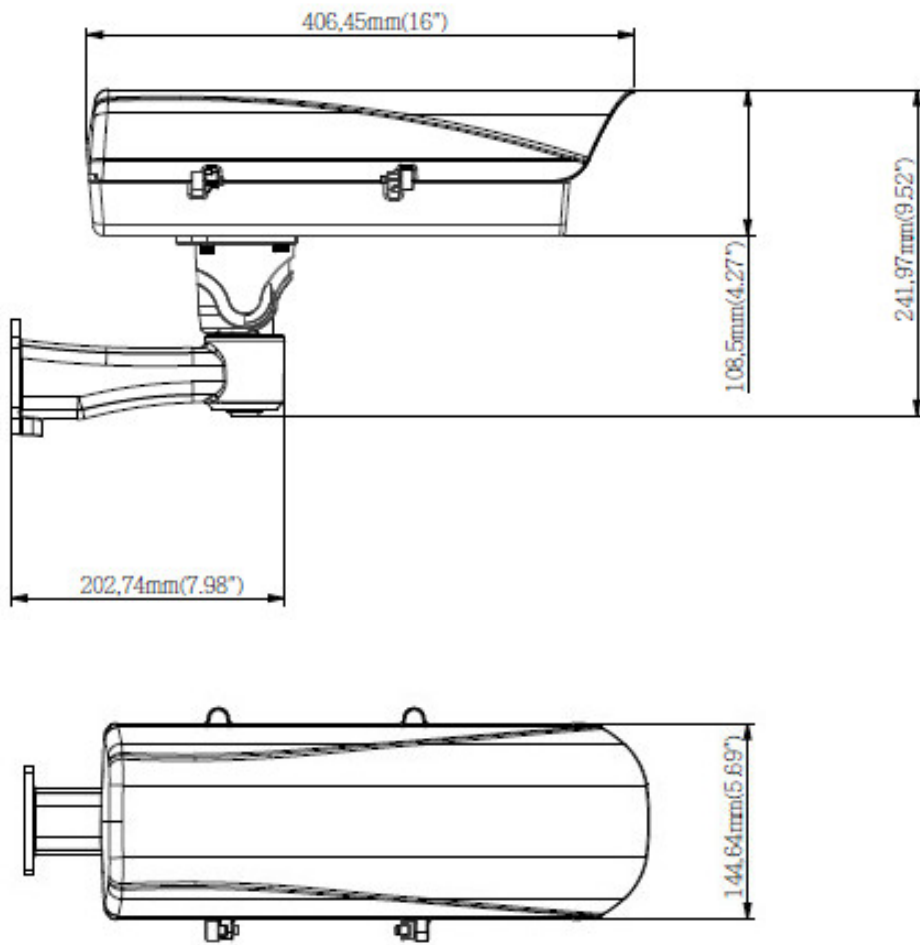



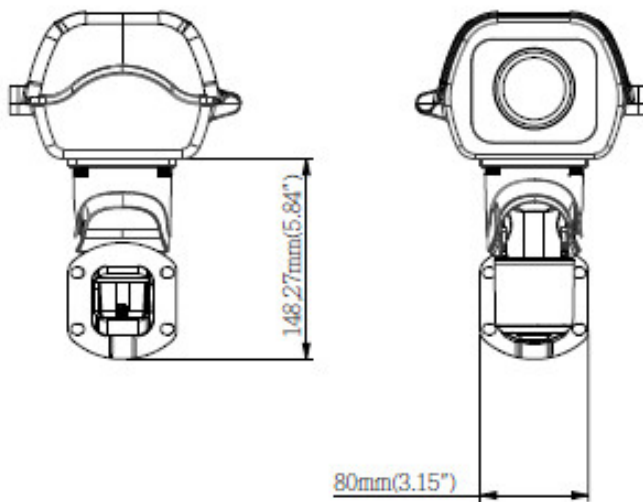

### Supporting Tube







## 1.3 Packing Lists

- **GV-Mount100**

<p>1. Junction Box</p> 	<p>2. Box Cover</p> 
<p>3. Tube</p> 	<p>4. Tube Connector</p> 
<p>5. M5 Flat Screw x 4</p> 	<p>6. Corrugated Tube Connector</p> 
<p>7. No. 2 Torx Wrench</p> 	

- **GV-Mount101**





<p>1. Mounting Bracket</p> 	<p>2. Tube</p> 
<p>3. Tube Connector</p> 	<p>4. No. 2 Torx Wrench</p> 

- **GV-Mount200**



1. Wall Pendant Tube









- **GV-Mount203**

<ol style="list-style-type: none"> <li>1. Junction Box</li> </ol> 	<ol style="list-style-type: none"> <li>2. Wall Pendant Tube</li> </ol> 
<ol style="list-style-type: none"> <li>3. M5 Screw x 2</li> </ol> 	<ol style="list-style-type: none"> <li>4. Corrugated Tube Connector</li> </ol> 
<ol style="list-style-type: none"> <li>5. No.5 Torx Wrench</li> </ol> 	

- **GV-Mount205**



<ol style="list-style-type: none"> <li>1. Wall Mount Bracket</li> </ol> 	<ol style="list-style-type: none"> <li>2. Mounting Plate</li> </ol> 
---	--

<p>3. Housing Plate</p> 	<p>4. M4 Screw (8 mm) x 15</p> 
<p>5. M4 Screw (40 mm) x 4</p> 	<p>6. Screw Anchor x 4</p> 
<p>7. M4.5 Plain Washer x 4</p> 	<p>8. M4 Split Washer x 4</p> 

**Note:** Installation of GV-Mount205 does not require all 15 M4 screws (8 mm) to be used. GV-FD Series and GV-FE Series need 10 M4 screws, while GV-VD Series need 11 M4 screws for installation.

• **GV-Mount300**

<p>1. Mounting Plate x 2</p> 	<p>2. M8 Screw (30 mm) x 4</p> 
<p>3. M8 Screw (25 mm) x 4</p> 	<p>4. M8 Plain Washer x 6</p> 
<p>5. M8 Split Washer x 6</p> 	<p>6. M8 Screw Cap x 6</p> 
<p>7. M5 Screw (20 mm) x 4</p> 	<p>8. M5 Plain Washer x 4</p> 

<p>9. M5 Split Washer x 4</p> 	<p>10. M5 Screw Cap x 4</p> 
---	---

• **GV-Mount310**

<p>1. Mounting Plate x 2</p> 	<p>2. M8 Screw (30 mm) x 4</p> 
<p>3. M8 Plain Washer x 6</p> 	<p>4. M8 Split Washer x 6</p> 
<p>5. M8 Screw Cap x 6</p> 	<p>6. M5 Screw (20 mm) x 4</p> 
<p>7. M5 Plain Washer x 4</p> 	<p>8. M5 Split Washer x 4</p> 
<p>9. M5 Screw Cap x 4</p> 	











• **GV-Mount400**

<p>1. Mounting Bracket</p> 	<p>2. Stainless Steel Strap (Ø 4" ~ 6") x 3</p> 
<p>3. M8 Screw (30 mm) x 4</p> 	<p>4. M8 Screw (25 mm) x 4</p> 





5. Plain Washer x 4 	6. Split Washer x 4 
7. M8 Screw Cap x 4 	8. M5 Screw (20 mm) x 4 
9. M5 Plain Washer x 4 	10. M5 Split Washer x 4 
11. M5 Screw Cap x 4 	



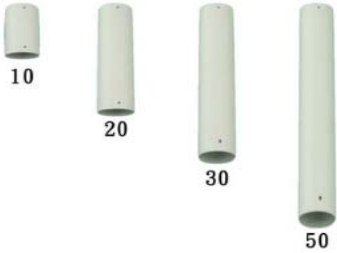

• **GV-Mount410**

1. Mounting Bracket 	2. Stainless Steel Strap (Ø 6" ~ 7.5") x 3 
3. M8 Screw (30 mm) x 4 	4. M8 Screw (25 mm) x 4 
5. Plain Washer x 4 	6. Split Washer x 4 
7. M8 Screw Cap x 4 	8. M5 Screw (20 mm) x 4 
9. M5 Plain Washer x 4 	10. M5 Split Washer x 4 
11. M5 Screw Cap x 4 	

• **GV-Mount702**

<p>1. Extension Tube</p> 	<p>2. Extension Tube Connector</p> 
--	--

• **GV-Mount900**

<p>1. Wall Mount Bracket</p> 	<p>2. Screw Anchor x 2</p> 
<p>3. Wall Mount Screw x 2</p> 	<p>4. M3 Screw (8 mm) x 4</p>  <p>* For GV-FD Series, GV-MFD Series, GV-MDR Series and GV-EFD1100</p>
<p>5. M5 Screw (10 mm) x 6</p>  <p>* For GV-VD Series</p>	

• **GV-Mount901**

<p>1. Dome Housing</p> 	<p>2. Housing Cap</p> 
<p>3. M4 Screw x 4</p> 	<p>4. M6 Screw x 7</p> 





• **GV-Mount902**

<p>1. Dome Housing</p> 	<p>2. Housing Cap</p> 
<p>3. M4 Screw x 4</p> 	<p>4. M6 Screw x 7</p> 
<p>5. Left and Right Rack</p> 	<p>6. Housing Plate</p> 
<p>7. Small Screw x 3</p> 	







• **GV-Mount903**



<p>1. Dome Housing</p> 	<p>2. Housing Cap</p> 
<p>3. M4 Screw x 4</p> 	<p>4. M6 Screw x 7</p> 

• **GV-Mount904**

<p>1. Back Cover</p> 	<p>2. Back Plate</p> 
<p>3. Tilting Rack</p> 	<p>4. Long Screw x 3</p> 
<p>5. Short Screw x 9</p> 	
<p>6. Installation Sticker</p>	

• **GV-Mount907**





<p>1. Support Rack x 3</p> 	<p>2. Mounting Ring</p> 
<p>3. Screw x 9</p> 	<p>4. Thread Lock, Screw, Washer</p> 
<p>5. Mounting Plate x 1</p> 	<p>6. Hex Key</p> 

<p>7. Lock Plate and Screw</p> 	<p>8. Installation Sticker</p>
<p>9. In-Ceiling Cover</p> 	

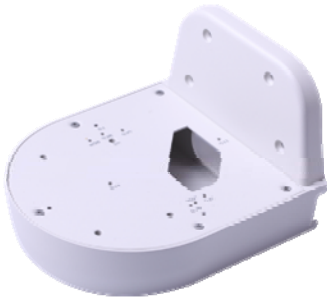

• **GV-Mount908**

<p>1. Housing Cap x 1</p> 	<p>2. Mounting Plate x 1</p> 
<p>3. Screw x 4</p> 	<p>4. M6 Screw x 4</p> 
<p>5. Hex key x 1</p> 	<p>6. Installation Sticker x 1</p>
<p>7. In-ceiling cover x 1</p> 	<p>8. M4 Screw x 2</p> 



- **GV-Mount909**

<p>1. Wall Bracket x 1</p> 	<p>2. Screw Anchor x 4</p> 
<p>3. Wall Mount Screw x 4</p> 	<p>4. M3 Screw (8 mm) x 4</p>  <p>* For GV-FD Series, GV-MFD Series, GV-MDR Series and GV-EFD1100</p>
<p>5. M5 Screw (10 mm) x 6</p> 	



- **GV-Mount910**

<p>1. Mounting Plate x 1</p> 	<p>2. M3 Screw (8 mm) x 4</p> 
--	---









- **GV-Mount912**

<p>1. Mounting Plate x 1</p> 	<p>2. M3 Screw (8 mm) x 4</p> 
--	---

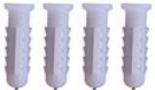
• **GV-Mount913**

<p>1. Mounting Plate x 1</p> 	<p>2. M3 Screw (8 mm) x 4</p> 
--	---

• **GV-Housing101**

<p>1. Housing Box x 1</p> 	<p>2. Supporting Tube x 1</p> 
<p>3. Screw Anchor x 4</p> 	<p>4. M5 Screw (35 mm) x 4</p> 
<p>5. Short Screw x 1</p> 	<p>6. M5 Plain Washer (7 mm) x 4</p> 
<p>7. M5 Plain Washer (16 mm) x 1</p> 	<p>8. Torx Wrench x 1</p> 
<p>9. Silica Gel Bag x 1</p> 	<p>10. Sticker (for Silica Gel Bag) x 1</p>

## 2. Installing the Vandal Proof IP Dome (Part I)

The information in this chapter applies to GV-VD120D / 121D / 122D / 123D / 220D / 221D / 222D / 223D / 320D / 321D / 322D / 323D / 1500 / 2400 / 2500 / 3400.

### 2.1 Assembling the Vandal Proof IP Dome with the dome housing



---

**Required accessories:**

- GV-Mount901
-



## 2 Installing the Vandal Proof IP Dome (Part I)

1. Unpack the camera body.

A.



B.



C.



D.



2. Secure the back cover to the dome housing (GV-Mount901, No. 1) with M4 screws (GV-Mount901, No. 3).



3. Thread the camera cable through the back cover and the dome housing.



4. Align the camera body so that the protruding part of the back cover fits the camera body and secure them together.



5. Thread the cable through the housing cap (GV-Mount901, No. 2) and secure with M6 screws (GV-Mount901, No. 4).

## 2.2 Straight Tube Box Mount



---

### Required accessories:

- GV-Mount100
- GV-Mount901

### The user needs to prepare:

- Screws for ceiling x 4
- Corrugated tube x 1 (3/4",  $\varnothing$  26.0 ~ 26.5 mm)



### Optionally extend with:

- GV-Mount702
-

1. Assemble the camera to the dome housing. See *2.1 Assembling the Vandal Proof IP Dome with the Dome Housing*.
2. Assemble the tube (GV-Mount100, No. 3) and the tube connector (GV-Mount100, No. 4).



3. Thread the camera cable through the tube and secure the tube to the end of the housing cap (GV-Mount901, No. 2) with M6 screws (GV-Mount901, No. 4).



4. Thread the camera cable through the box cover (GV-Mount100, No. 2), assemble the box cover and the tube, and tighten the torxes using the torx wrench (GV-Mount100, No. 7).



## 2 Installing the Vandal Proof IP Dome (Part I)

- Secure the junction box (GV-Mount100, No. 1) to the ceiling with 4 self-prepared screws.



- Assemble the corrugated tube connector (GV-Mount100, No. 6) with the self-prepared corrugated tube.
  - Dismantle the supplied corrugated tube connector. You should have 4 parts.



- Slide part A and part B to the self-prepared corrugated tube.



- Screw part C to the tube.
- Thread the necessary wires and cables from the ceiling through the corrugated tube, plug the tube to the junction box and secure with part D.

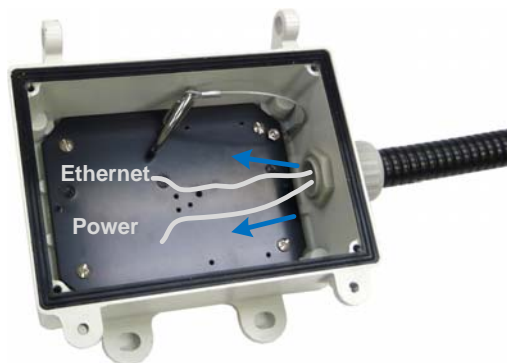

- Connect the network, power and other cables to the camera. See *Connecting the Camera, Vandal Proof IP Dome (Part I) Chapter, GV-IP Cam H.264 User's Manual* on the software CD.

- Hook the box cover and secure it with M5 flat screws (GV-Mount100, No. 5).

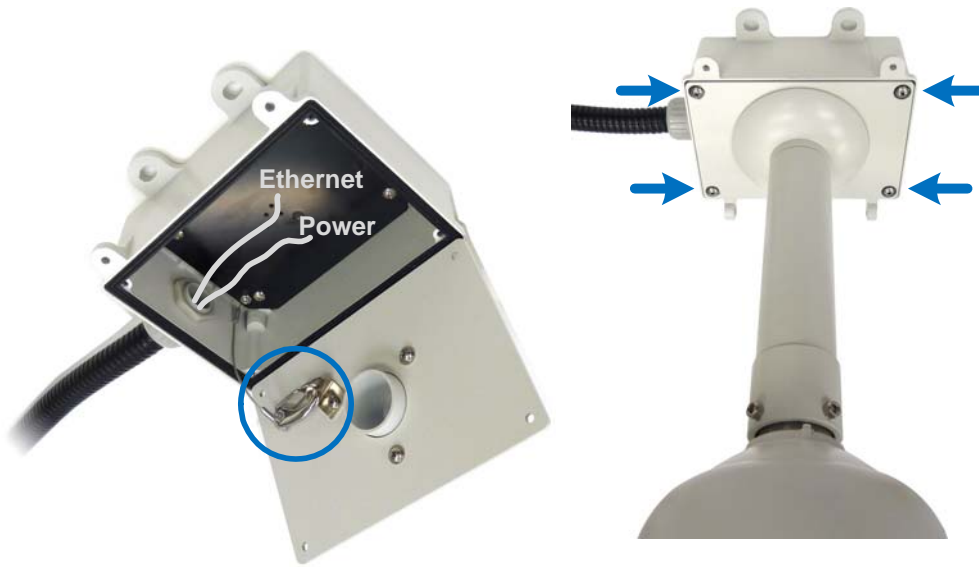

- Refer to the indicated sections of the **GV-IPCam H.264 User's Manual on the software CD** to:
  - Access live view. See *Accessing the Live View, Getting Started* Chapter.
  - Adjust the angle, focus and zoom of the camera. See steps 9 and 10 in *Hard-Ceiling Mount, Vandal Proof IP Dome (Part I)* Chapter
  - Secure the thread lock, replace the silica gel bag and secure the housing cover. See steps 11 to 13 in *Hard-Ceiling Mount, Vandal Proof IP Dome (Part I)* Chapter.

## 2.3 Straight Tube Mount

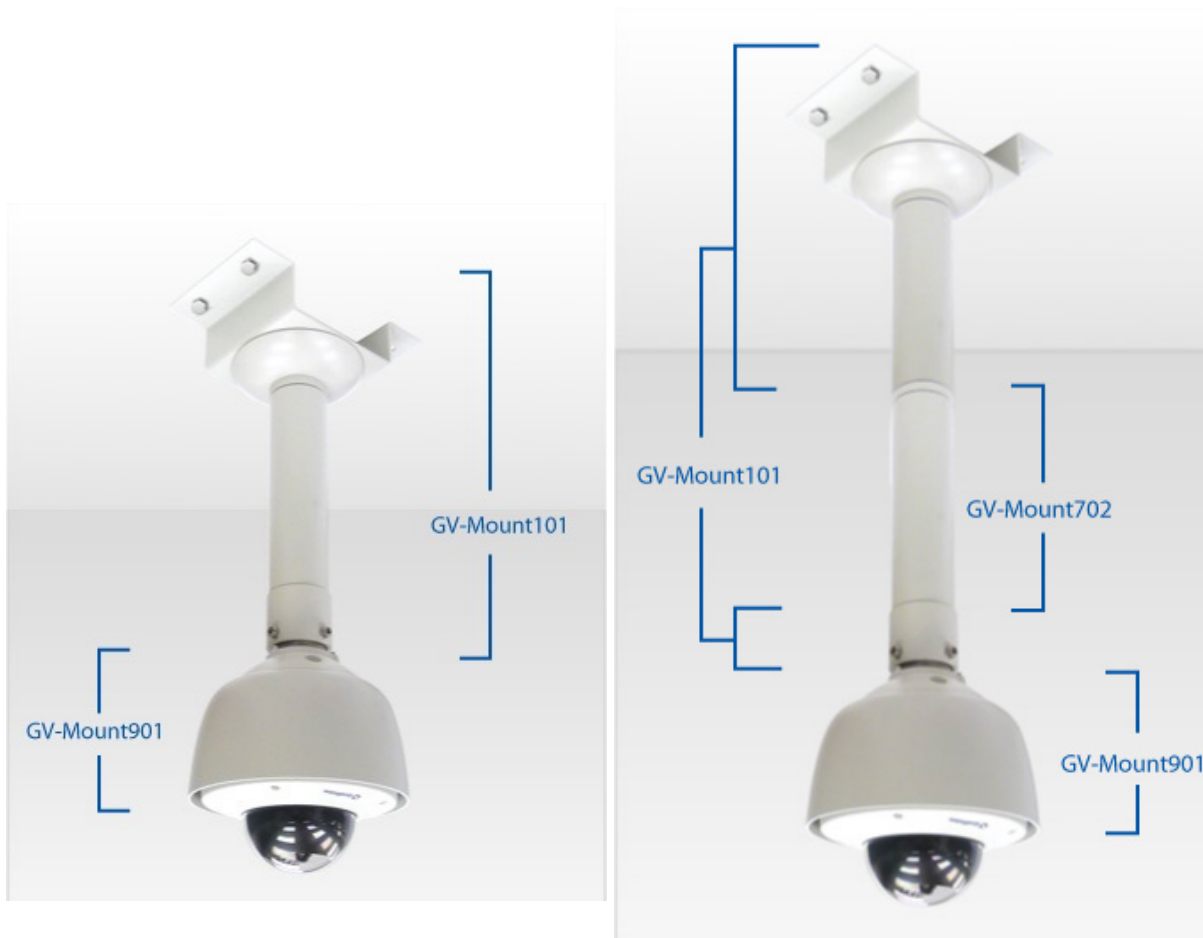

---

**Required accessories:**

- GV-Mount101
- GV-Mount901

**The user needs to prepare:**

- Screws for ceiling x 4

**Optionally extend with:**

- GV-Mount702
-

1. Assemble the camera with the dome housing. See *2.1 Assembling the Vandal Proof IP Dome with the Dome Housing*.
2. Assemble the tube (GV-Mount101, No. 2) and the tube connector (GV-Mount101, No. 3).



3. Thread the camera cable through the tube and assemble the tube to the end of the housing cap (GV-Mount901, No. 2) with M6 screws (GV-Mount901, No. 4).



4. Thread the camera cable through the mounting bracket (GV-Mount101, No. 1) and assemble the tube with the mounting bracket.
5. Make sure the tubes are properly screwed and tighten with the supplied torx wrench (GV-Mount101, No. 4).



6. Secure the assembled camera to a desired location with 4 self-prepared screws.



## 2 Installing the Vandal Proof IP Dome (Part I)

7. Refer to the indicated sections of the **GV-IPCam H.264 User's Manual on the software CD** to:
  - A. Connect the network, power and other cables to the camera. See *Connecting the Camera, Vandal Proof IP Dome (Part I)* Chapter.
  - B. Access live view. See *Accessing the Live View, Getting Started* Chapter.
  - C. Adjust the angle, focus and zoom of the camera. See steps 9 and 10 in *Hard-Ceiling Mount, Vandal Proof IP Dome (Part I)* Chapter.
  - D. Secure the thread lock, replace the silica gel bag and secure the housing cover. See steps 11 to 13 in *Hard-Ceiling Mount, Vandal Proof IP Dome (Part I)* Chapter.

## 2.4 Wall Mount



---

### Required accessories:

- GV-Mount205
- 

1. Take the wall mount bracket (GV-Mount205, No. 1) and make 4 marks on the wall for screw anchors.



2. Drill the marks and insert 4 screw anchors (GV-Mount205, No. 6).
3. Align and secure the mounting plate (GV-Mount205, No. 2) to the wall mount bracket with 4 M4 screws (GV-Mount205, No. 4).

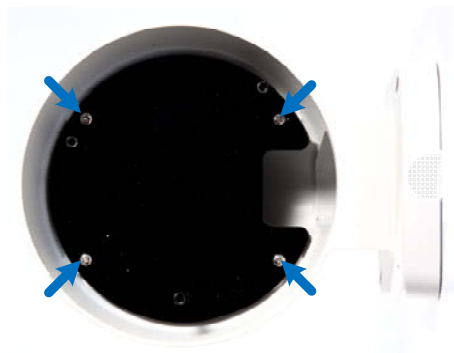

## 2 Installing the Vandal Proof IP Dome (Part I)

- Align and secure the housing plate (GV-Mount205, No. 3) to the mounting plate with 3 M4 screws (GV-Mount205, No. 4).

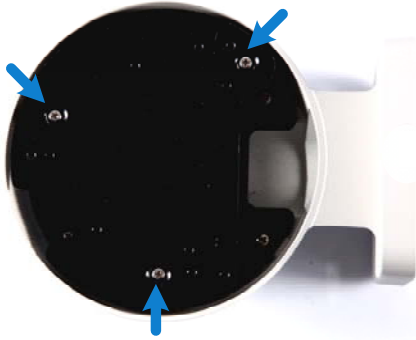

- Unpack the camera body.

A.



B.



C.



D.



- Align and secure the camera's back cover to the housing plate with 4 M4 screws (GV-Mount205, No. 4).

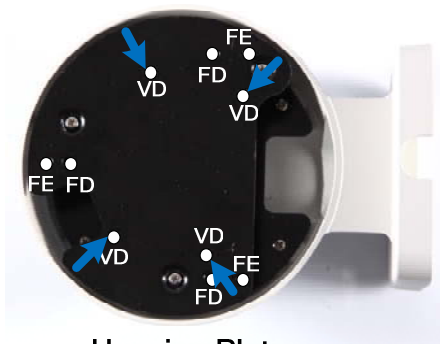

Housing Plate

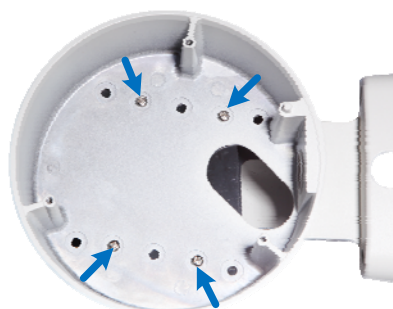

Back Cover

7. Thread the camera cable through the conduit entry at the bottom of the back cover and the wall mount bracket, and refer to step 5D and 5C to secure the camera to the back cover.

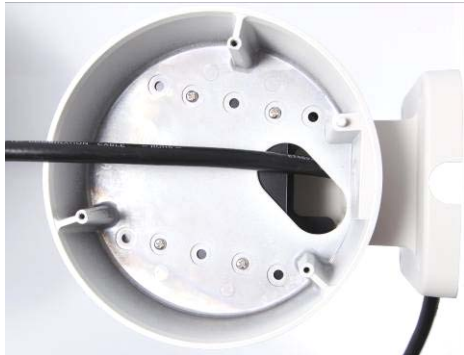

8. Secure the wall mount bracket to the wall with 40 mm M4 screws (GV-Mount205, No. 5) and plain washers (GV-Mount205, No. 7).
9. Refer to the indicated sections of the **GV-IPCam H.264 User's Manual on the software CD** to:
  - A. Connect the network, power and other cables to the camera. See *Connecting the Camera, Vandal Proof IP Dome (Part I)* Chapter.
  - B. Access live view. See *Accessing the Live View, Getting Started* Chapter.
  - C. Adjust the angle, focus and zoom of the camera. See steps 9 and 10 in *Hard-Ceiling Mount, Vandal Proof IP Dome (Part I)* Chapter.
  - D. Secure the thread lock, replace the silica gel bag and secure the housing cover. See steps 11 to 13 in *Hard-Ceiling Mount, Vandal Proof IP Dome (Part I)* Chapter.

## 2.5 L-Shaped Wall Mount



---

### Required accessories:

- GV-Mount900
- 

2. Take the wall mount bracket (GV-Mount900, No. 1) and make 2 marks on the wall for screw anchors.

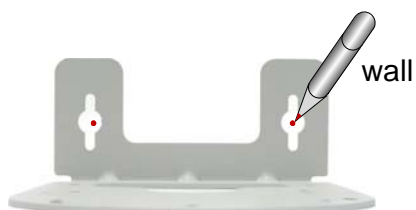

3. Drill the marks and insert 2 screw anchors (GV-Mount900, No. 2).
4. Insert the wall mount screws (GV-Mount900, No. 3) and leave enough distance (approximately 2 mm) to hang the wall mount bracket later.

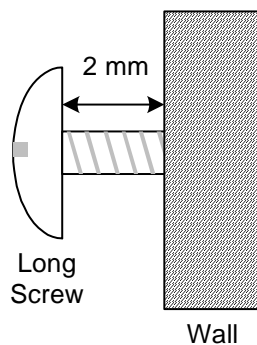

5. Hang the wall mount bracket on the wall mount screws and push the wall mount bracket downward. Tighten the screws to the wall.

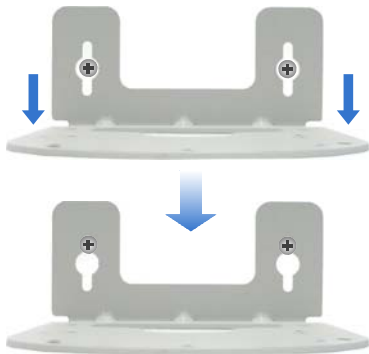

6. Unpack the camera body.

A.



B.



C.



D.



## 2 Installing the Vandal Proof IP Dome (Part I)

7. Align and secure the back cover to the wall mount bracket with M5 screws (GV-Mount900, No. 5).

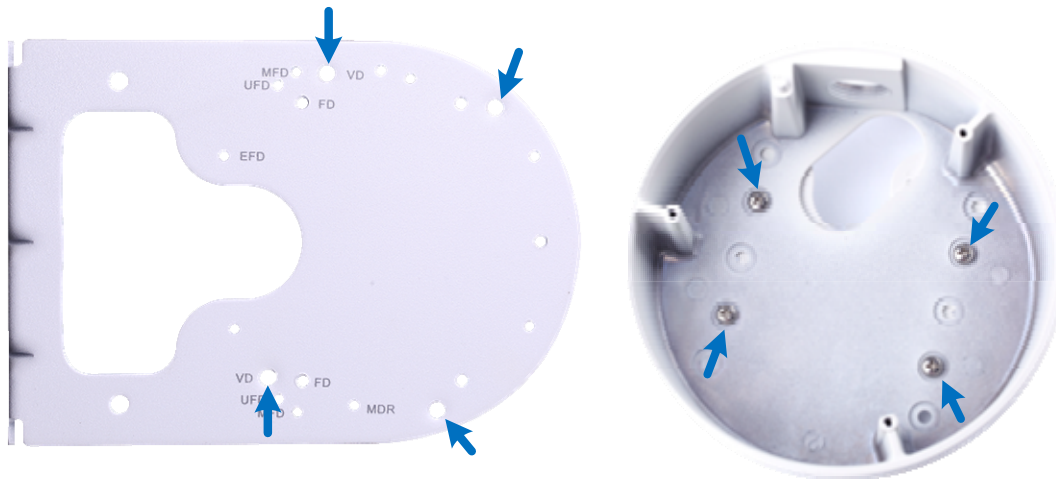

8. Thread the cable through the conduit entry at the bottom of the back cover and follow steps 5C and 5D to re-assemble the camera.



9. Refer to the indicated sections of the **GV-IPCam H.264 User's Manual on the software CD** to:
  - A. Connect the network, power and other cables to the camera. See *Connecting the Camera, Vandal Proof IP Dome (Part I)* Chapter.
  - B. Access live view. See *Accessing the Live View, Getting Started* Chapter.
  - C. Adjust the angle, focus and zoom. See steps 9 and 10 in *Hard-Ceiling Mount, Vandal Proof IP Dome (Part I)* Chapter.
  - D. Secure the thread lock, replace the silica gel bag and secure the housing cover. See steps 11 to 13 in *Hard-Ceiling Mount, Vandal Proof IP Dome (Part I)* Chapter.

## 2.6 Wall Box Mount



---

### Required accessories:

- GV-Mount909
- 

**IMPORTANT:** The GV-Mount909 is not IP66 protected. Make sure you install the camera in a dry place.

---

1. Take the wall mount bracket (GV-Mount909, No. 1) and make 4 marks on the wall for screw anchors.

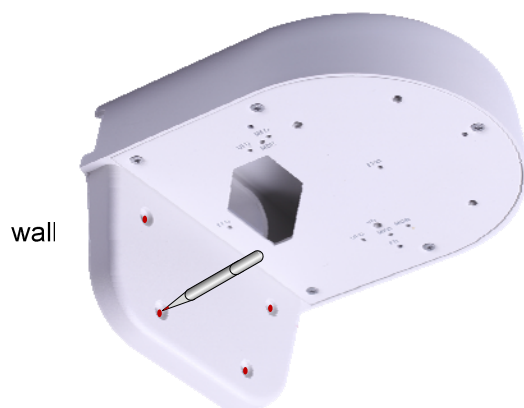

2. Drill the marks and insert 4 screw anchors (GV-Mount909, No. 2).
3. Secure the wall mount bracket to the wall with wall mount screws (GV-Mount909, No. 3).



## 2 Installing the Vandal Proof IP Dome (Part I)

4. Unpack the camera body.

A.



B.



C.



D.



5. Align and secure the back cover to the wall mount bracket with four M5 screws (GV-Mount909, No. 5).

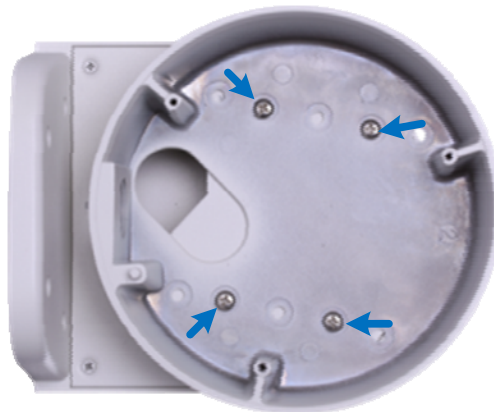
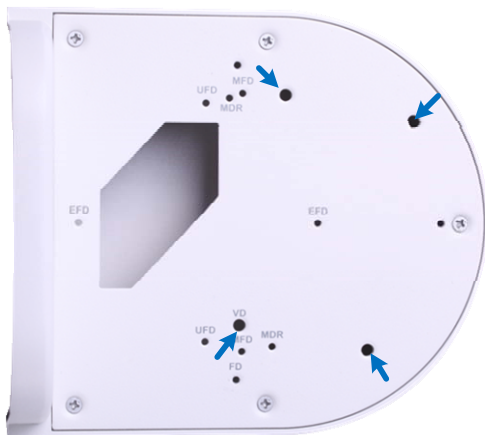

6. Thread the cable through the back cover and wall mount bracket, and follow step 4C and 4D to secure the camera to the back cover.

7. Refer to the indicated sections of the **GV-IPCam H.264 User's Manual on the software CD** to:

- A. Access live view. See *Accessing the Live View, Getting Started* Chapter.
- B. Adjust the angle, focus and zoom of the camera. See steps 9 and 10 in *Hard-Ceiling Mount, Vandal Proof IP Dome (Part I)* Chapter.
- C. Secure the thread lock, replace the silica gel bag and secure the housing cover. See steps 11 to 13 in *Hard-Ceiling Mount, Vandal Proof IP Dome (Part I)* Chapter.

## 2.7 Wall Pendant Mount



---

**Required accessories:**

- GV-Mount200
- GV-Mount901

**The user needs to prepare:**

- Screws for wall x 4
- 

1. Assemble the camera with the dome housing. See *2.1 Assembling the Vandal Proof IP Dome with the Dome Housing*.
2. Thread the camera cable through the wall pendant tube (GV-Mount200, No. 1) and secure the tube to the end of the housing cap (GV-Mount901, No. 2) with M6 screws (GV-Mount901, No. 4).



## 2 Installing the Vandal Proof IP Dome (Part I)

3. Secure the wall pendant tube to the wall with 4 self-prepared screws.
4. Refer to the indicated sections of the **GV-IPCam H.264 User's Manual on the software CD** to:
  - A. Access live view. See *Accessing the Live View, Getting Started* Chapter.
  - B. Adjust the angle, focus and zoom of the camera. See steps 9 and 10 in *Hard-Ceiling Mount, Vandal Proof IP Dome (Part I)* Chapter.
  - C. Secure the thread lock, replace the silica gel bag and secure the housing cover. See steps 11 to 13 in *Hard-Ceiling Mount, Vandal Proof IP Dome (Part I)* Chapter.

## 2.8 Convex Corner Mount with Pendant Tube



---

### Required accessories:

- GV-Mount200
- GV-Mount300
- GV-Mount901

### The user needs to prepare:

- Screws for wall x 8
- 

1. Assemble the camera with the dome housing. See *2.1 Assembling the Vandal Proof IP Dome with the Dome Housing*.
2. Thread the camera cable through the wall pendant tube (GV-Mount200, No. 1), and secure the tube to the end of the housing cap (GV-Mount901, No. 2) with M6 screws (GV-Mount901, No. 4).



## 2 Installing the Vandal Proof IP Dome (Part I)

3. Assemble the mounting plates (GV-Mount300, No. 1), slide in the plain washer (GV-Mount300, No. 4), then the split washer (GV-Mount300, No. 5), and secure with the screw cap (GV-Mount300, No. 6).

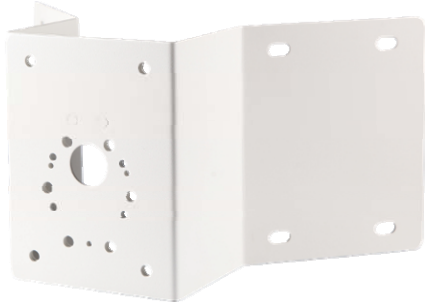

4. Thread the camera cable and secure the pendant tube to the mounting plates. Slide the 30 mm M8 screws (GV-Mount300, No. 3) from front and secure from the backside using plain washer (GV-Mount300, No. 4), split washer (GV-Mount300, No. 5) and screw cap (GV-Mount300, No. 6).



**Backside View**

5. Secure the plates to the wall with 8 self-prepared screws.
6. Refer to the indicated sections of the **GV-IPCam H.264 User's Manual on the software CD** to:
  - A. Connect the network, power and other cables to the camera. See *Connecting the Camera, Vandal Proof IP Dome (Part I)* Chapter.
  - B. Access the live view. See *Accessing the Live View, Getting Started* Chapter.
  - C. Adjust the angle, focus and zoom of the camera. See steps 9 and 10 in *Hard-Ceiling Mount, Vandal Proof IP Dome (Part I)* Chapter.
  - D. Secure the thread lock, replace the silica gel bag and secure the housing cover. See steps 11 to 13 in *Hard-Ceiling Mount, Vandal Proof IP Dome (Part I)* Chapter.

## 2.9 Convex Corner Mount with Wall Bracket

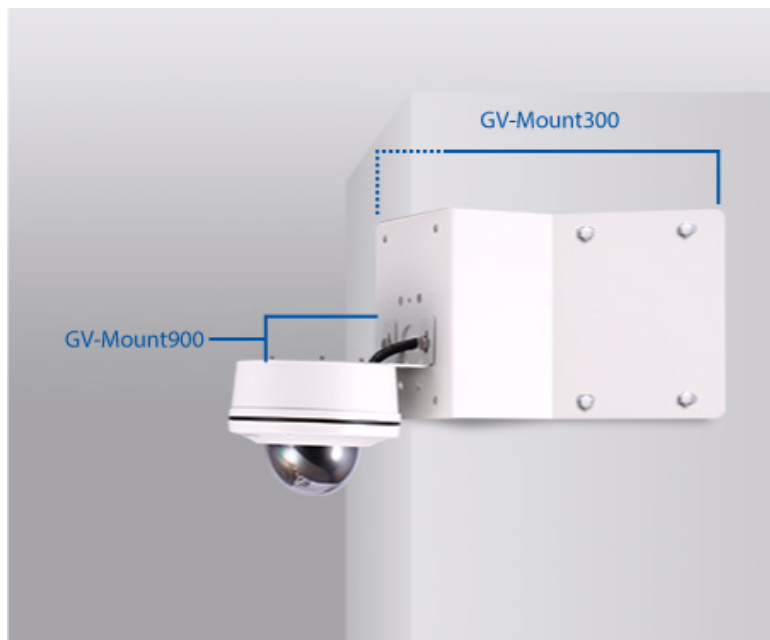

---

**Required accessories:**

- GV-Mount300
- GV-Mount900

**The user needs to prepare:**

- Screws for wall x 8

- 
1. Assemble the mounting plates (GV-Mount300, No. 1), slide in the plain washer (GV-Mount300, No. 4), then the split washer (GV-Mount300, No. 5), and secure with the screw cap (GV-Mount300, No. 6).

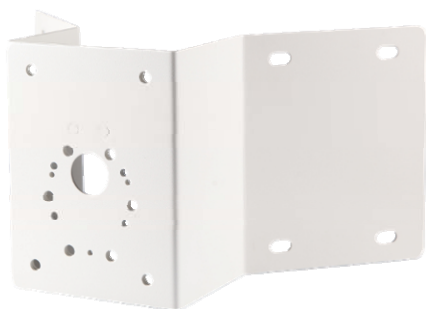

## 2 Installing the Vandal Proof IP Dome (Part I)

2. Assemble the camera with the wall mount bracket (GV-Mount900, No.1).

A. Unpack the camera body.

A-1



A-2



A-3



A-4



B. Secure the back cover to the wall mount bracket from the interior with M5 screws (GV-Mount900, No. 5).



- C. Thread the cable through the conduit entry at the bottom of the back cover and follow step 2A-3 and 2A-4 to secure the camera body.



3. Assemble the camera with the mounting plates.
  - A. Thread the camera cable through the mounting plates.
  - B. Slide the 30 mm M8 screws (GV-Mount300, No. 2) from front and secure from the backside using plain washer (GV-Mount300, No. 4), split washer (GV-Mount300, No. 5) and screw cap (GV-Mount300, No. 6).



**Backside View**

4. Secure the plates to the wall with 8 self-prepared screws.
5. Refer to the indicated sections of the **GV-IPCam H.264 User's Manual on the software CD** to:
  - A. Connect the network, power and other cables to the camera. See *Connecting the Camera, Vandal Proof IP Dome (Part I)* Chapter.
  - B. Access the live view. See *Accessing the Live View, Getting Started* Chapter.
  - C. Adjust the angle, focus and zoom of the camera. See steps 9 and 10 in *Hard-Ceiling Mount, Vandal Proof IP Dome (Part I)* Chapter.



## 2 Installing the Vandal Proof IP Dome (Part I)

- D. Secure the thread lock, replace the silica gel bag and secure the housing cover. See steps 11 to 13 in *Hard-Ceiling Mount, Vandal Proof IP Dome (Part I)* Chapter.

---

**Note:** You can use a corrugated tube to waterproof the cable.

---

## 2.10 Convex Corner Box Mount

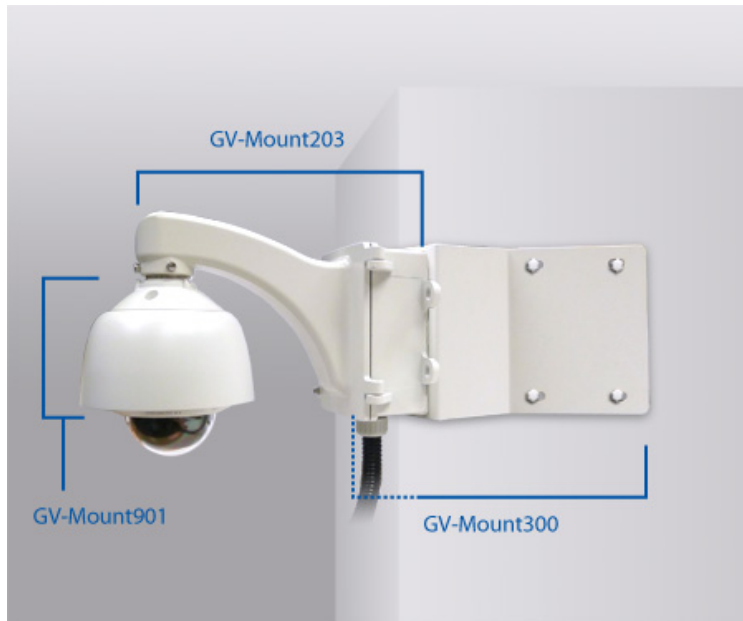

---

### Required accessories:

- GV-Mount203
- GV-Mount300
- GV-Mount901

### The user needs to prepare:

- Screws for wall x 8
- Corrugated tube (3/4",  $\varnothing$  26.0 ~ 26.5 mm)



## 2 Installing the Vandal Proof IP Dome (Part I)

1. Assemble the camera with the dome housing. See 2.1 *Assembling the Vandal Proof IP Dome with the Dome Housing*.
2. Assemble the mounting plates (GV-Mount300, No. 1), slide in the plain washer (GV-Mount300, No. 4), then the split washer (GV-Mount300, No. 5), and secure them with the screw cap (GV-Mount300, No. 6).

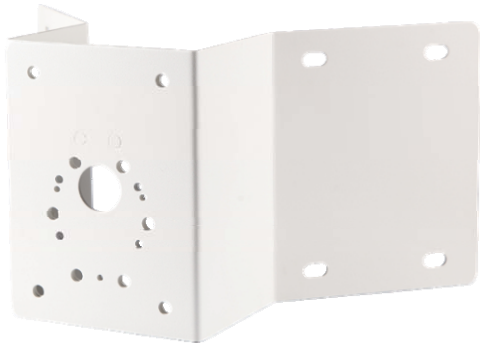

3. Secure the junction box (GV-Mount203, No. 1) to the plate from the backside using the 25 mm M8 screw (GV-Mount300, No. 3), plain washer (GV-Mount300, No. 4) and split washer (GV-Mount300, No. 5).



**Back View**

4. Secure the plates to the wall with 8 self-prepared screws. Face the conduit exit downward.



5. Assemble the corrugated tube connector (GV-Mount203, No. 4) with the self-prepared corrugated tube.

A. Dismantle the supplied corrugated tube connector. You should have 4 parts.



B. Slide part A and part B to the self-prepared corrugated tube.

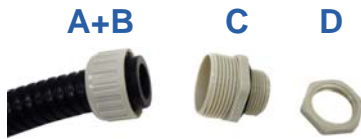

C. Screw part C to the tube.

D. Thread the necessary wires and cables from the wall or the ceiling through the corrugated tube, plug the tube to the junction box and secure with part D.

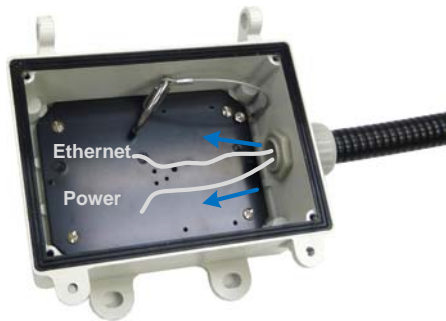

6. Thread the camera cable through the wall pendant tube (GV-Mount203, No. 2), and secure the tube to the end of the housing cap (GV-Mount901, No. 2) with M6 screws (GV-Mount901, No. 4).

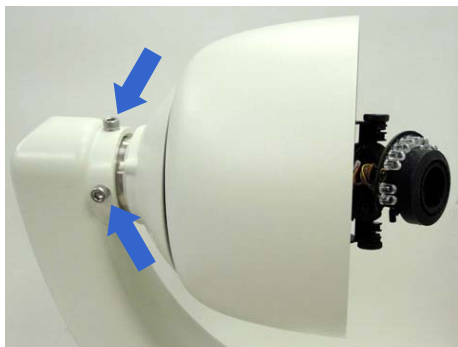

## 2 Installing the Vandal Proof IP Dome (Part I)

7. Hinge and hook the pendant tube to the junction box.



8. Connect the network, power and other cables to the camera. See *Connecting the Camera, Vandal Proof IP Dome (Part I)* Chapter, *GV-IPCam H.264 User's Manual* on the software CD.
9. Conceal the junction box with M5 screws (GV-Mount203, No. 3) using the torx wrench (GV-Mount203, No. 5).
10. Refer to the indicated sections of the **GV-IPCam H.264 User's Manual on the software CD** to:
  - A. Access the live view. See *Accessing the Live View, Getting Started* Chapter.
  - B. Adjust the angle, focus and zoom of the camera. See steps 9 and 10 in *Hard-Ceiling Mount, Vandal Proof IP Dome (Part I)* Chapter.
  - C. Secure the thread lock, replace the silica gel bag and secure the housing cover. See steps 11 to 13 in *Hard-Ceiling Mount, Vandal Proof IP Dome (Part I)* Chapter.

## 2.11 Concave Corner Mount with Pendant Tube

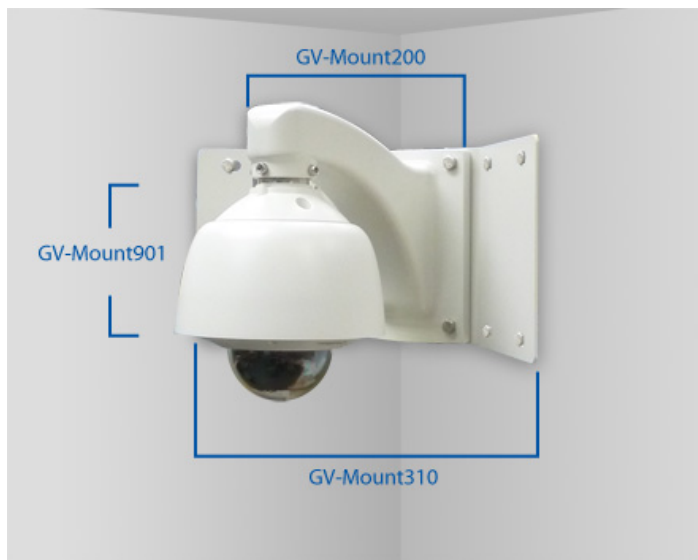

---

**Required accessories:**

- GV-Mount200
- GV-Mount310
- GV-Mount901

**The user needs to prepare:**

- Screws for wall x 8
- 

1. Assemble the mounting plates (GV-Mount310, No. 1), slide in the plain washer (GV-Mount310, No. 3), then the split washer (GV-Mount310, No. 4), and secure them with the screw cap (GV-Mount310, No. 5).

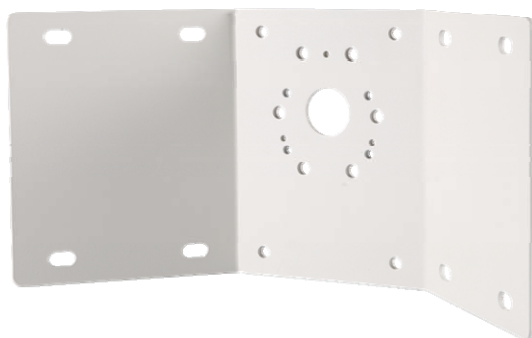

## 2 Installing the Vandal Proof IP Dome (Part I)

2. Thread the camera cable and secure the pendant tube to the plates. Slide the 30 mm M8 screws (GV-Mount310, No. 2) from the front and secure from the backside using plain washer (GV-Mount310, No. 3), split washer, (GV-Mount310, No. 4) and M8 screw cap (GV-Mount310, No. 5).

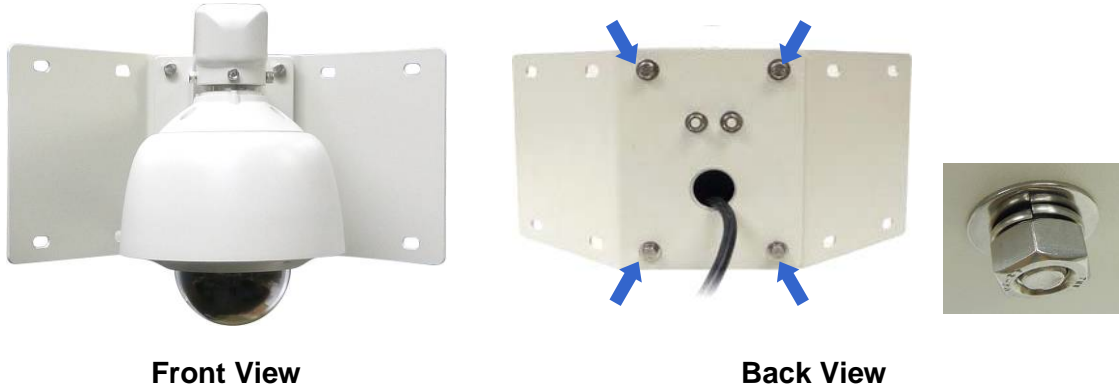

3. Secure the plates to the wall with 8 self-prepared screws.
4. Refer to the indicated sections of the **GV-IPCam H.264 User's Manual on the software CD** to:
  - A. Connect the network, power and other cables to the camera. See *Connecting the Camera, Vandal Proof IP Dome (Part I)* Chapter.
  - B. Access the live view. See *Accessing the Live View, Getting Started* Chapter.
  - C. Adjust the angle, focus and zoom of the camera. See steps 9 and 10 in *Hard-Ceiling Mount, Vandal Proof IP Dome (Part I)* Chapter.
  - D. Secure the thread lock, replace the silica gel bag and secure the housing cover. See steps 11 to 13 in *Hard-Ceiling Mount, Vandal Proof IP Dome (Part I)* Chapter.

## 2.12 Concave Corner Mount with Wall Bracket

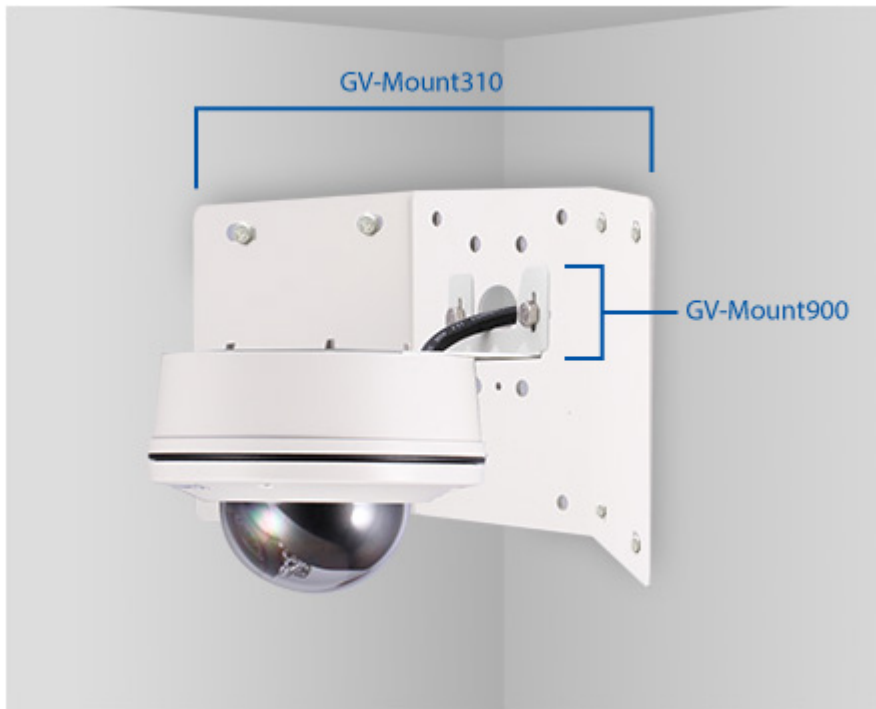

---

**Required accessories:**

- GV-Mount310
- GV-Mount900

**The user needs to prepare:**

- Screws for wall x 8
- 

1. Assemble the mounting plates (GV-Mount310, No. 1), slide in the plain washer (GV-Mount310, No. 3), then the split washer (GV-Mount310, No. 4), and secure them with the screw cap (GV-Mount310, No. 5).

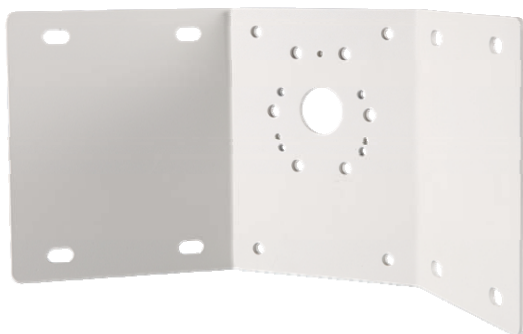



## 2 Installing the Vandal Proof IP Dome (Part I)

2. Assemble the camera with the wall mount bracket (GV-Mount900, No.1).

A. Unpack the camera body.

A-1



A-2



A-3



A-4



B. Secure the back cover to the wall mount bracket with M5 screws (GV-Mount900, No. 5).



- C. Thread the cable through the conduit entry at the bottom of the back cover and follow step 2A-3 and 2A-4 to secure the camera body.



3. Assemble the camera with the mounting plates.
  - A. Thread the camera cable through the mounting plates.
  - B. Slide the 30 mm M8 screws (GV-Mount310, No. 2) from the front and secure from the backside using plain washer (GV-Mount310, No. 3), split washer, (GV-Mount310, No. 4) and M8 screw cap (GV-Mount310, No. 5).



**Front View**

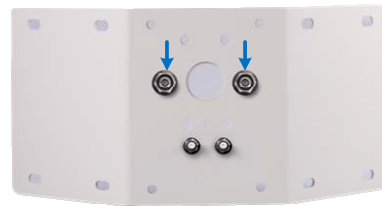

**Back View**

4. Secure the plates to the wall with 8 self-prepared screws.
5. Refer to the indicated sections of the **GV-IPCam H.264 User's Manual on the software CD** to:
  - A. Connect the network, power and other cables to the camera. See *Connecting the Camera, Vandal Proof IP Dome (Part I)* Chapter.
  - B. Access the live view. See *Accessing the Live View, Getting Started* Chapter.
  - C. Adjust the angle, focus and zoom of the camera. See steps 9 and 10 in *Hard-Ceiling Mount, Vandal Proof IP Dome (Part I)* Chapter.
  - D. Secure the thread lock, replace the silica gel bag and secure the housing cover. See steps 11 to 13 in *Hard-Ceiling Mount, Vandal Proof IP Dome (Part I)* Chapter.

---

**Note:** You can use a corrugated tube to waterproof the cable.

---

## 2.13 Pole Mount with Pendant Tube



---

**Required accessories:**

- GV-Mount200
  - GV-Mount400 or GV-Mount410
  - GV-Mount901
- 

1. Assemble the camera with the dome housing. See 2.1 *Assembling the Vandal Proof IP Dome with the Dome Housing*.
2. Secure the mounting bracket (GV-Mount400 / GV-Mount410, No. 1) to the pole using 3 steel straps (GV-Mount400 / GV-Mount410, No. 2). Rotate the screw on the strap to adjust its size.



5. Thread the camera cable through the pendant tube (GV-Mount200, No. 1) and secure the tube to the end of the housing cap (GV-Mount901, No. 2) with M6 screws (GV-Mount901, No. 4).



6. Thread the camera cable through the mounting bracket and secure the pendant tube to the mounting bracket. Slide the 30 mm M8 screws (GV-Mount400 / GV-Mount410, No. 3) from the front and secure from the backside using plain washer (GV-Mount400 / GV-Mount410, No. 5), split washer (GV-Mount400 / GV-Mount410, No. 6) and screw cap (GV-Mount400 / GV-Mount410, No. 7).



**Backside View**

7. Refer to the indicated sections of the **GV-IPCam H.264 User's Manual on the software CD** to:
  - A. Connect the network, power and other cables to the camera. See *Connecting the Camera, Vandal Proof IP Dome (Part I)* Chapter.
  - B. Access the live view. See *Accessing the Live View, Getting Started* Chapter.
  - C. Adjust the angle, focus and zoom of the camera. See steps 9 and 10 in *Hard-Ceiling Mount, Vandal Proof IP Dome (Part I)* Chapter.
  - D. Secure the thread lock, replace the silica gel bag and secure the housing cover. See steps 11 to 13 in *Hard-Ceiling Mount, Vandal Proof IP Dome (Part I)* Chapter.

## 2.14 Pole Mount with Wall Bracket

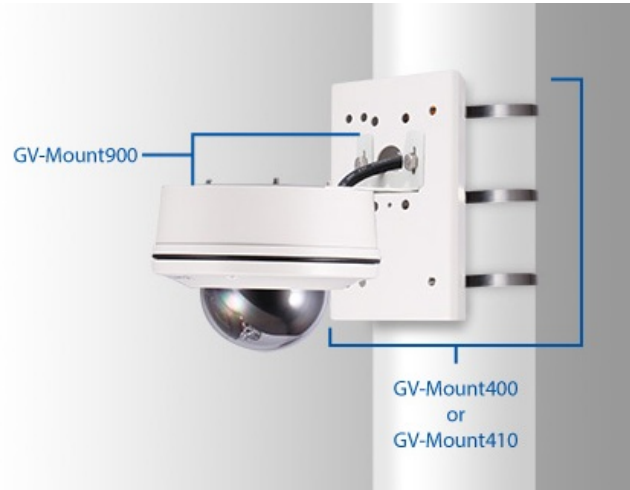

---

### Required accessories:

- GV-Mount400 or GV-Mount410
  - GV-Mount900
- 

1. Assemble the camera with the wall mount bracket (GV-Mount900, No.1).

A. Unpack the camera body.

A-1



A-2



A-3 Unscrew



A-4



- B. Secure the back cover to the wall mount bracket with M5 screws (GV-Mount900, No. 5).



- C. Thread the cable through the conduit entry at the bottom of the back cover and follow step 2A-3 and 2A-4 to secure the camera body.



- 2. Assemble the camera with the mounting bracket (GV-Mount400 / GV-Mount410, No.1).

- A. Thread the camera cable through the mounting bracket.
- B. Slide the 30 mm M8 screws (GV-Mount400 / GV-Mount410, No. 3) from the front and secure from the backside using plain washer (GV-Mount400 / GV-Mount410, No. 5), split washer, (GV-Mount400 / GV-Mount410, No. 6) and M8 screw cap (GV-Mount400 / GV-Mount410, No. 7).



**Backside View**

## 2 Installing the Vandal Proof IP Dome (Part I)

3. Secure the mounting bracket to the pole using 3 steel straps (GV-Mount400 / GV-Mount410, No. 2). Rotate the screw on the strap to adjust its size.



4. Refer to the indicated sections of the **GV-IPCam H.264 User's Manual on the software CD** to:
  - A. Connect the network, power and other cables to the camera. See *Connecting the Camera, Vandal Proof IP Dome (Part I)* Chapter.
  - B. Access the live view. See *Accessing the Live View, Getting Started* Chapter.
  - C. Adjust the angle, focus and zoom of the camera. See steps 9 and 10 in *Hard-Ceiling Mount, Vandal Proof IP Dome (Part I)* Chapter.
  - D. Secure the thread lock, replace the silica gel bag and secure the housing cover. See steps 11 to 13 in *Hard-Ceiling Mount, Vandal Proof IP Dome (Part I)* Chapter.

---

**Note:** You can use a corrugated tube to waterproof the cable.

---

## 2.15 Pole Box Mount

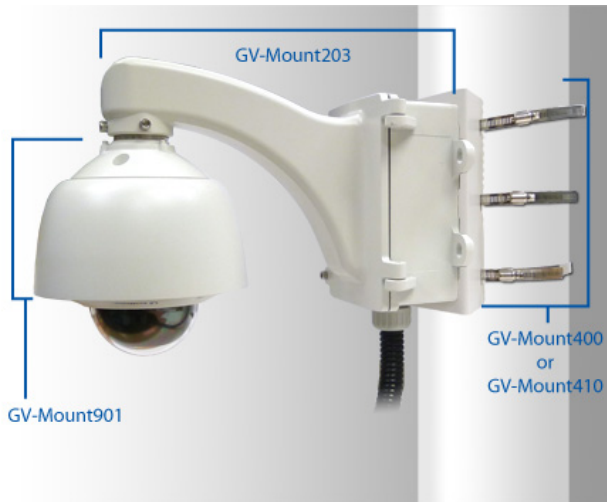

---

### Required accessories:

- GV-Mount203
- GV-Mount400 or GV-Mount410
- GV-Mount901

### The user needs to prepare:

- Corrugated tube x 1 (3/4",  $\varnothing$  26.0 ~ 26.5 mm)



- 
1. Assemble the camera with the dome housing. See *2.1 Assembling the Vandal Proof IP Dome with the Dome Housing*.
  2. Assemble the mounting bracket (GV-Mount400 / GV-Mount410, No. 1) and the junction box (GV-Mount203, No. 1) from the backside using 25 mm M8 screws (GV-Mount400 / GV-Mount410, No. 4), plain washer (GV-Mount400 / GV-Mount410, No. 5) and split washers (GV-Mount400 / GV-Mount410, No. 6).



**Backside View**



## 2 Installing the Vandal Proof IP Dome (Part I)

3. Secure the mounting bracket to the pole using 3 steel straps (GV-Mount400 / GV-Mount410, No. 2). Rotate the screw on the strap to adjust its size. Face the conduit exit downward.



4. Assemble the corrugated tube connector (GV-Mount203, No. 4) with the self-prepared corrugated tube.
  - A. Dismantle the supplied corrugated tube connector. You should have 4 parts.



- B. Slide part A and part B to the self-prepared corrugated tube.

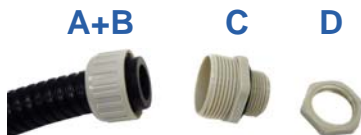

- C. Screw part C to the tube.
- D. Thread the necessary wires and cables through the corrugated tube, plug the tube to the junction box and secure with part D.

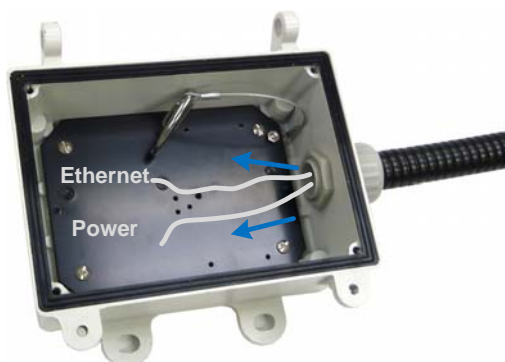

5. Thread the camera cable through the pendant tube (GV-Mount203, No. 2) and secure the tube to the end of the housing cap (GV-Mount901, No. 2) with M6 screws (GV-Mount901, No. 4).



6. Hinge and hook the pendant tube to the junction box.



7. Connect the network, power and other cables to the camera. See *Connecting the Camera, Vandal Proof IP Dome (Part I) Chapter, GV-IPCam H.264 User's Manual* on the software CD.
8. Conceal the junction box with M5 screws (GV-Mount203, No. 3) using the torx wrench (GV-Mount203, No. 5).
9. Refer to the indicated sections of the **GV-IPCam H.264 User's Manual on the software CD** to:
  - A. Access the live view. See *Accessing the Live View, Getting Started Chapter*.
  - B. Adjust the angle, focus and zoom of the camera. See steps 9 and 10 in *Hard-Ceiling Mount, Vandal Proof IP Dome (Part I) Chapter*.
  - C. Secure the thread lock, replace the silica gel bag and secure the housing cover. See steps 11 to 13 in *Hard-Ceiling Mount, Vandal Proof IP Dome (Part I) Chapter*.

## 2.16 Power Box Mount



---

**The user needs to prepare**

- Screws for securing the camera to power box
- 

Supported Power Box Types			
Single Gang	Double Gang	4" Octagon	4" Square
	✓		✓

1. Unpack the camera body.

A.



B.



C.



D.



2. Thread the camera cable through the back cover and into the power box and secure the back cover to the power box with self-prepared screws.

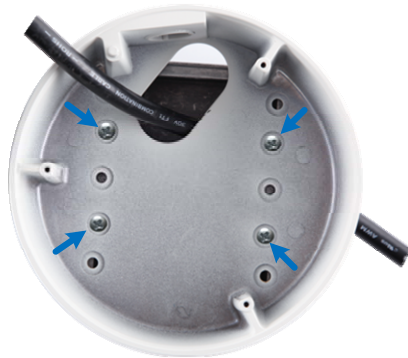

3. Follow steps 1B to 1D to assemble the camera.

4. Refer to the indicated sections of the **GV-IPCam H.264 User's Manual on the software CD** to:

- A. Access the live view. See *Accessing the Live View, Getting Started* Chapter.
- B. Adjust the angle, focus and zoom of the camera. See steps 9 and 10 in *Hard-Ceiling Mount, Vandal Proof IP Dome (Part I)* Chapter.
- C. Secure the thread lock, replace the silica gel bag and secure the housing cover. See steps 11 to 13 in *Hard-Ceiling Mount, Vandal Proof IP Dome (Part I)* Chapter.

# Note for Installing the Vandal Proof IP Dome

When installing GV-VD1530 / 1540 / 1540-E / 2430 / 2440 / 2440-E / 2530 / 2540 / 2540-E / 3430 / 3440 / 3440-E / 5340 / 5340-E, be sure that:

1. When installing the camera near the corner, maintain at least 25 cm away from the walls to avoid reflections.
2. If the center of the camera view is less than  $25^\circ$  to the ceiling, or lower than the grey line (as illustrated below), disassemble the indicated ring so the view is not obstructed. However, with the ring disassembled, slight reflections may occur.



## 3. Installing the Vandal Proof IP Dome (Part II)

The information in this chapter applies to GV-VD1530 / 1540 / 1540-E / 2430 / 2440 / 2440-E / 2530 / 2540 / 2540-E / 3430 / 3440 / 3440-E / 5340 / 5340-E.

### 3.1 Straight Tube Box Mount



---

#### Required accessories:

- GV-Mount100
- GV-Mount903

#### The user needs to prepare:

- Screws for ceiling x 4
- Corrugated tube x 1 (3/4",  $\varnothing$  26.0 ~ 26.5 mm)



#### Optionally extend with:

- GV-Mount702
-

### 3 Installing the Vandal Proof IP Dome (Part II)

1. Assemble the corrugated tube connector (GV-Mount100, No. 6) with the self-prepared corrugated tube and the junction box (GV-Mount100, No. 1).

A. Dismantle the supplied corrugated tube connector. You should have 4 parts.



B. Slide part A and part B to the self-prepared corrugated tube.

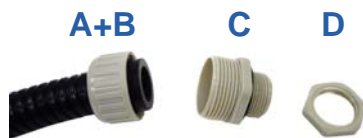

C. Screw part C to the tube.

D. Thread the power, network and other wires from the ceiling through the corrugated tube into the junction box and secure with part D.

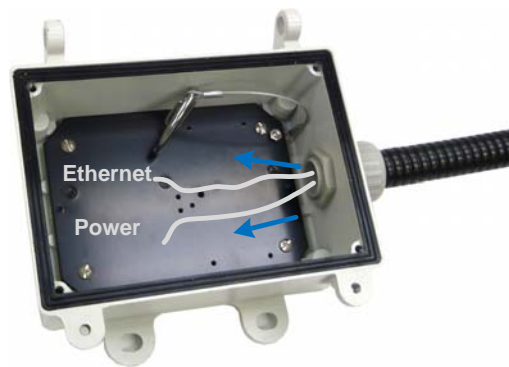

2. Secure the junction box to the ceiling with self-prepared screws.
3. Assemble the box cover (GV-Mount100, No.2) with the tube (GV-Mount100, No. 3), tube connector (GV-Mount100, No. 4), housing cap (GV-Mount903, No. 2) and then the dome housing (GV-Mount903, No.1) with M6 screws (GV-Mount903, No. 4).



4. Thread the power (supplied), network (self-prepared) and other wires (supplied) through the box cover and into the dome housing.
5. Secure the supplied back plate to the dome housing.



6. Thread the wires into the camera. See steps 1 to 3 in *Installation, Vandal Proof IP Dome (Part II) Chapter, GV-IPCam H.264 User's Manual* on the software CD.
7. Secure the camera to the back plate with the supplied torx wrench.

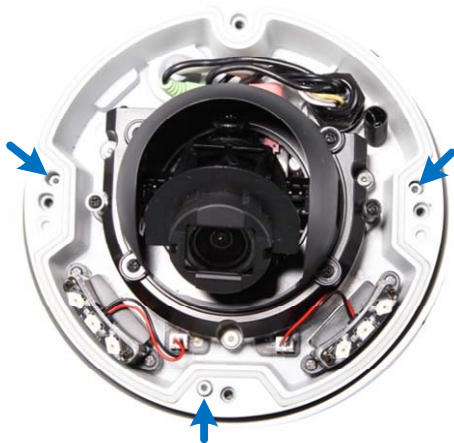

8. Hinge and hook the box cover to the junction box.





### 3 Installing the Vandal Proof IP Dome (Part II)

9. Connect the wires and close the box cover with M5 flat screws (GV-Mount100, No. 5).



10. Refer to the indicated sections of the **GV-IPCam H.264 User's Manual on the software CD** to:
  - A. Access live view. See *Accessing the Live View, Getting Started* Chapter.
  - B. Adjust the angle, focus and zoom of the camera. See step 8 in *Installation, Vandal Proof IP Dome (Part II)* Chapter.
  - C. Replace the silica gel bag and secure the housing cover. See step 9 in *Installation, Vandal Proof IP Dome (Part II)* Chapter.

## 3.2 Straight Tube Mount



---

**Required accessories:**

- GV-Mount101
- GV-Mount903

**The user needs to prepare:**

- Screws for ceiling x 4

**Optionally extend with:**

- GV-Mount702
-

### 3 Installing the Vandal Proof IP Dome (Part II)

1. Assemble the mounting bracket (GV-Mount101, No. 1), tube (GV-Mount101, No. 2), tube connector (GV-Mount101, No. 3), housing cap (GV-Mount903, No. 2) and the dome housing (GV-Mount903, No. 1) with M6 screws (GV-Mount903, No. 4).



2. Thread the power (supplied), network (self-prepared) and other wires (supplied) through the box cover and into the dome housing.
3. Secure the supplied back plate to the dome housing.



4. Thread the wires into the camera. See steps 1 to 3 in *Installation, Vandal Proof IP Dome (Part II) Chapter, GV-IPCam H.264 User's Manual* on the software CD.
5. Secure the camera to the back plate with the supplied torx wrench.

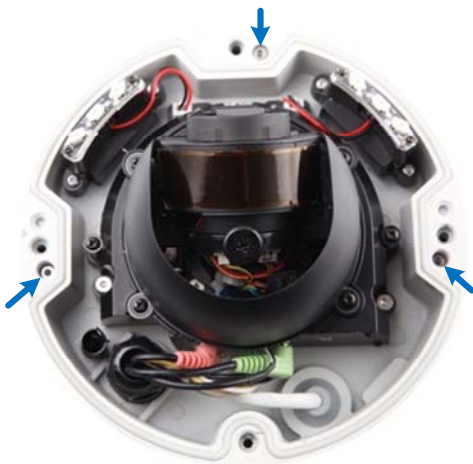

6. Connect the camera wires with the wires from the ceiling

7. Secure the camera to the ceiling with self-prepared screws.
8. Refer to the indicated sections of the **GV-IPCam H.264 User's Manual on the software CD** to:
  - A. Access live view. See *Accessing the Live View, Getting Started* Chapter.
  - B. Adjust the angle, focus and zoom of the camera. See step 8 in *Installation, Vandal Proof IP Dome (Part II)* Chapter.
  - C. Replace the silica gel bag and secure the housing cover. See step 9 in *Installation, Vandal Proof IP Dome (Part II)* Chapter.

### 3.3 Wall Mount



---

**Required accessories:**

- GV-Mount205
- 

1. Take the wall mount bracket (GV-Mount205, No. 1) and make 4 marks on the wall for screw anchors.



2. Drill the marks and insert 4 screw anchors (GV-Mount205, No. 6).
3. Align and secure the mounting plate (GV-Mount205, No. 2) to the wall mount bracket with 4 M4 screws (GV-Mount205, No. 4).

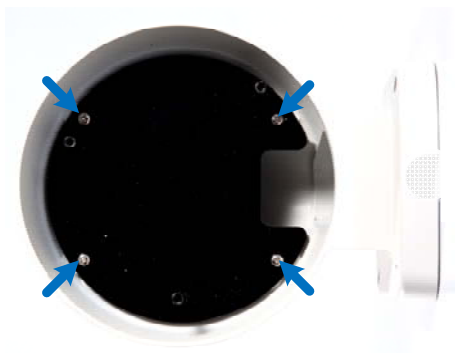

- Align and secure the housing plate (GV-Mount205, No. 3) to the mounting plate with 3 M4 screws (GV-Mount205, No. 4).

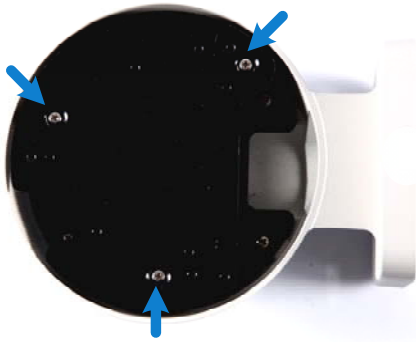

- Align and secure the camera's back plate to the housing plate with 4 M4 screws (GV-Mount205, No. 4).

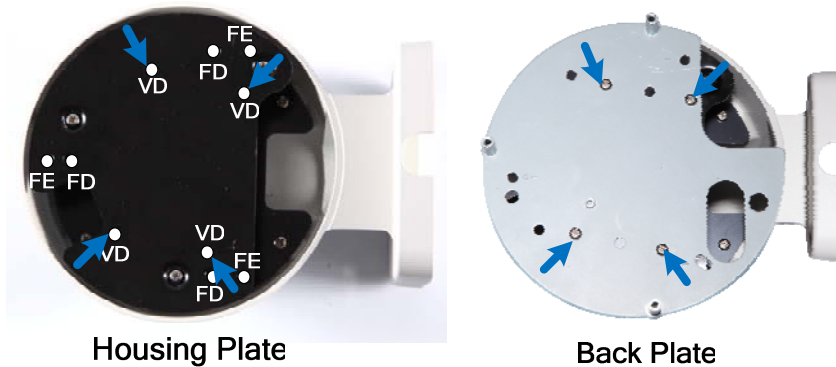

- Thread the camera cables through the wall mount bracket.

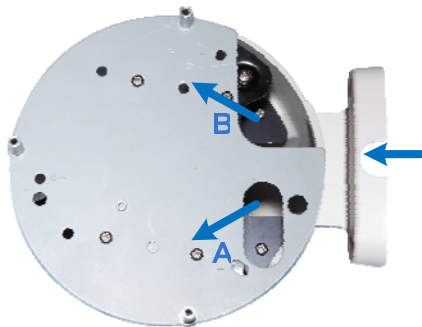

- Thread the wires of power adapter, audio (optional), TV out (optional) and I/O devices (optional) through the hole labeled A.
  - Thread the RJ-45 cable through the hole labeled B.
- Thread and connect the related wires to the camera. See steps 1 to 4 in *Installation, Vandal Proof IP Dome (Part II) Chapter, GV-IPCam H.264 User's Manual* on the software CD.

### 3 Installing the Vandal Proof IP Dome (Part II)

8. Align and secure the camera to the back plate with the supplied torx wrench.

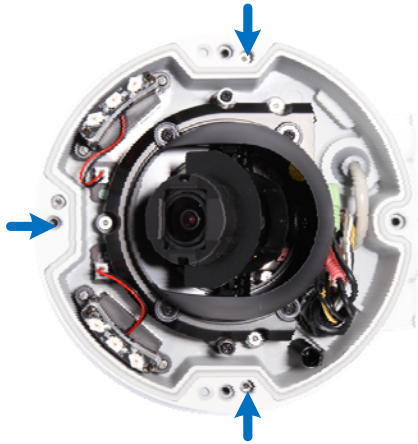

9. Secure the wall mount bracket to the wall with 40 mm M4 screws (GV-Mount205, No. 5) and plain washers (GV-Mount205, No. 7).
10. Refer to the indicated sections of the **GV-IPCam H.264 User's Manual on the software CD** to:
  - A. Access live view. See *Accessing the Live View, Getting Started* Chapter.
  - B. Adjust the angle, focus and zoom of the camera. See step 8 in *Installation, Vandal Proof IP Dome (Part II)* Chapter.
  - C. Replace the silica gel bag and secure the housing cover. See step 9 in *Installation, Vandal Proof IP Dome (Part II)* Chapter.

## 3.4 L-Shaped Wall Mount



---

**Required accessories:**

- GV-Mount900
- 

1. Take the wall mount bracket (GV-Mount900, No. 1) and make 2 marks on the wall for screw anchors.

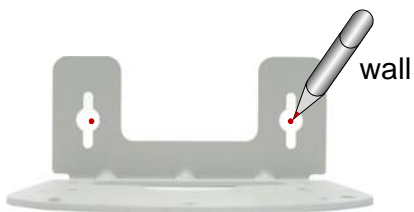

2. Drill the marks and insert 2 screw anchors (GV-Mount900, No. 2).



### 3 Installing the Vandal Proof IP Dome (Part II)

3. Insert the ceiling screws (GV-Mount900, No. 3) and leave enough distance (approximately 2 mm) to hang the wall mount bracket later.

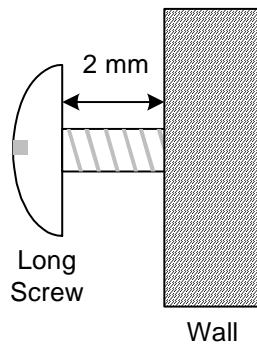

4. Align and secure the supplied back plate to the wall mount bracket with M5 screws (GV-Mount900, No. 5).

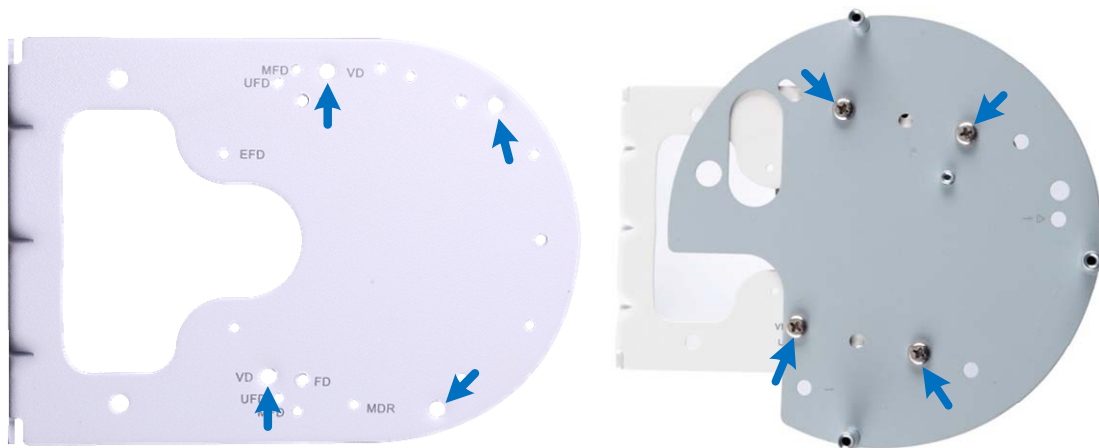

5. Thread the power (supplied), network (self-prepared) and other wires (supplied) through the wall mount bracket and into the camera. See steps 1 to 4 in *Installation, Vandal Proof IP Dome (Part II) Chapter, GV-IPCam H.264 User's Manual* on the software CD.
6. Secure the camera to the wall mount bracket with the supplied torx wrench.

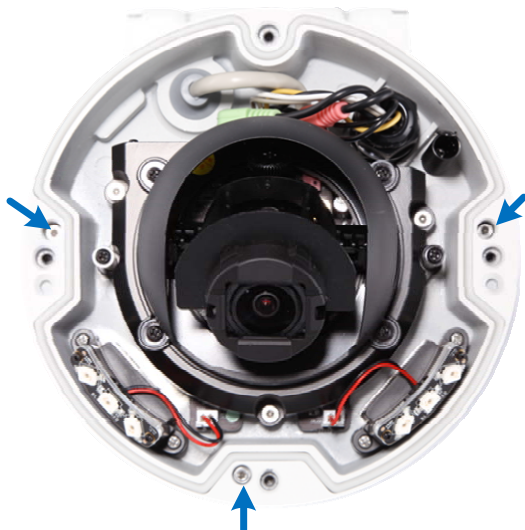

7. Hang the wall mount bracket on the ceiling screws, push the wall mount bracket downward and tighten the screws to the wall.

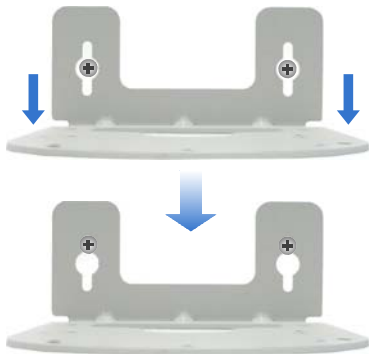

8. Connect the camera wires with wires from the wall.
9. Refer to the indicated sections of the **GV-IPCam H.264 User's Manual on the software CD** to:
  - A. Access live view. See *Accessing the Live View, Getting Started* Chapter.
  - B. Adjust the angle, focus and zoom of the camera. See step 8 in *Installation, Vandal Proof IP Dome (Part II)* Chapter.
  - C. Replace the silica gel bag and secure the housing cover. See step 9 in *Installation, Vandal Proof IP Dome (Part II)* Chapter.

## 3.5 Wall Box Mount



---

**Required accessories:**

- GV-Mount909
- 

**IMPORTANT:** The GV-Mount909 is not IP66 protected. Make sure you install the camera in a dry place.

---

1. Take the wall mount bracket (GV-Mount909, No. 1) and make 4 marks on the wall for screw anchors.



2. Drill the marks and insert 4 screw anchors (GV-Mount909, No. 2).

3. Secure the supplied back plate to the wall mount bracket with four M5 screws (GV-Mount909, No. 5).

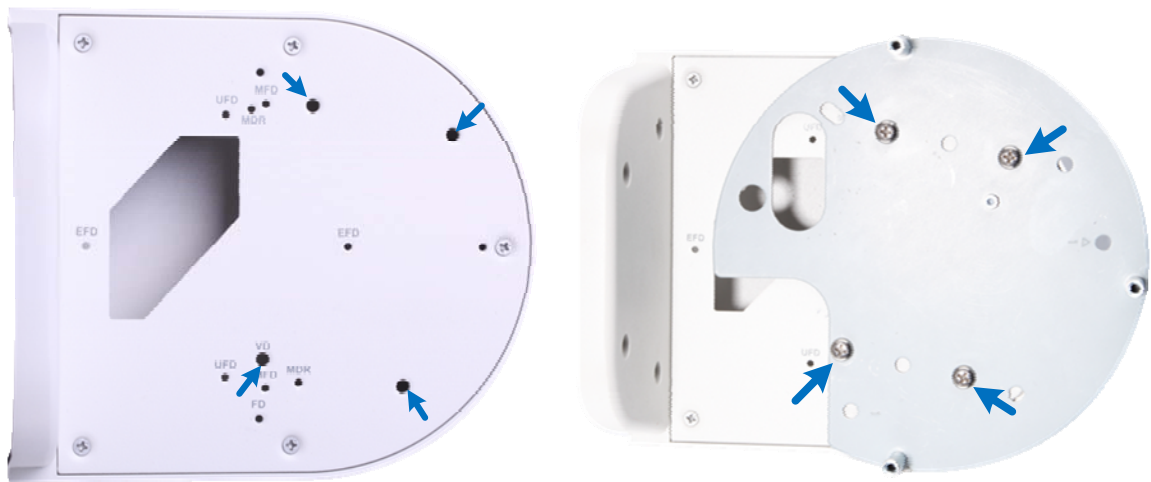

4. Thread the power (supplied), network (self-prepared) and other wires (supplied) through the wall mount bracket and into the camera. See steps 1 to 4 in *Installation, Vandal Proof IP Dome (Part II)* Chapter, *GV-IPCam H.264 User's Manual* on the software CD
5. Secure the camera to the wall mount bracket with the supplied torx wrench.

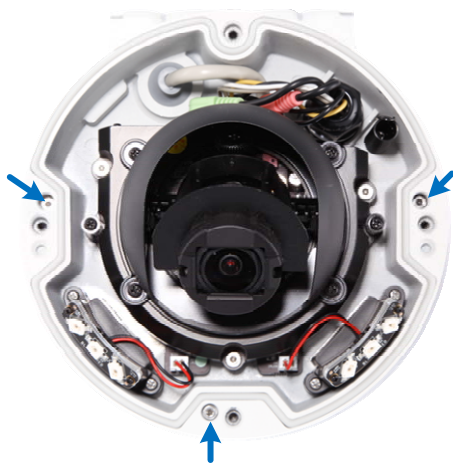

6. Connect the camera wires with wires from the wall.
7. Secure the wall mount bracket to the wall with wall mount screws (GV-Mount909, No. 3).
8. Refer to the indicated sections of the **GV-IPCam H.264 User's Manual on the software CD** to:
  - A. Access live view. See *Accessing the Live View, Getting Started* Chapter.
  - B. Adjust the angle, focus and zoom of the camera. See step 8 in *Installation, Vandal Proof IP Dome (Part II)* Chapter.
  - C. Replace the silica gel bag and secure the housing cover. See step 9 in *Installation, Vandal Proof IP Dome (Part II)* Chapter.

## 3.6 Wall Pendant Mount



---

**Required accessories:**

- GV-Mount200
- GV-Mount903

**The user needs to prepare:**

- Screws for wall x 4
-

1. Assemble the pendant tube (GV-Mount200, No. 1) with the housing cap (GV-Mount903, No. 2) and then the dome housing (GV-Mount903, No. 1) with M6 screws (GV-Mount903, No. 4).



2. Thread the power (supplied), network (self-prepared) and other wires (supplied) through the pendant tube and into the dome housing.
3. Secure the supplied back plate to the dome housing.



4. Thread the wires into the camera. See steps 1 to 4 in *Installation, Vandal Proof IP Dome (Part II) Chapter, GV-IPCam H.264 User's Manual* on the software CD.
5. Secure the camera to the back plate with the supplied torx wrench.



### 3 Installing the Vandal Proof IP Dome (Part II)

6. Connect the camera wires with wires from the wall.
7. Secure the wall pendant tube to the wall with 4 self-prepared screws.
8. Refer to the indicated sections of the **GV-IPCam H.264 User's Manual on the software CD** to:
  - A. Access live view. See *Accessing the Live View, Getting Started* Chapter.
  - B. Adjust the angle, focus and zoom of the camera. See step 8 in *Installation, Vandal Proof IP Dome (Part II)* Chapter.
  - C. Replace the silica gel bag and secure the housing cover. See step 9 in *Installation, Vandal Proof IP Dome (Part II)* Chapter.

## 3.7 Convex Corner Mount with Pendant Tube



---

**Required accessories:**

- GV-Mount200
- GV-Mount300
- GV-Mount903

**The user needs to prepare:**

- Screws for wall x 8
- 

1. Assemble the mounting plates (GV-Mount300, No. 1). Slide in the plain washer (GV-Mount300, No. 4), the split washer (GV-Mount300, No. 5), and secure with the screw cap (GV-Mount300, No. 6).

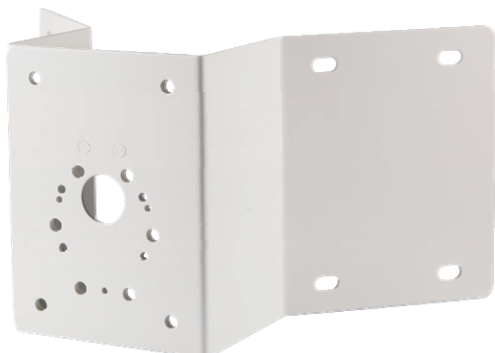



### 3 Installing the Vandal Proof IP Dome (Part II)

2. Assemble the pendant tube (GV-Mount200, No. 1) with the housing cap (GV-Mount903, No. 2) and then the dome housing (GV-Mount903, No. 1) with M6 screws (GV-Mount903, No. 4).



3. Thread the power (supplied), network (self-prepared) and other wires (supplied) through the pendant tube and into the dome housing.
4. Secure the supplied back plate to the dome housing.



5. Secure the pendant tube to the mounting plates. Slide the 30 mm M8 screws (GV-Mount300, No. 3) from front and secure from the backside using plain washer (GV-Mount300, No. 4), split washer (GV-Mount300, No. 5) and screw cap (GV-Mount300, No. 6).

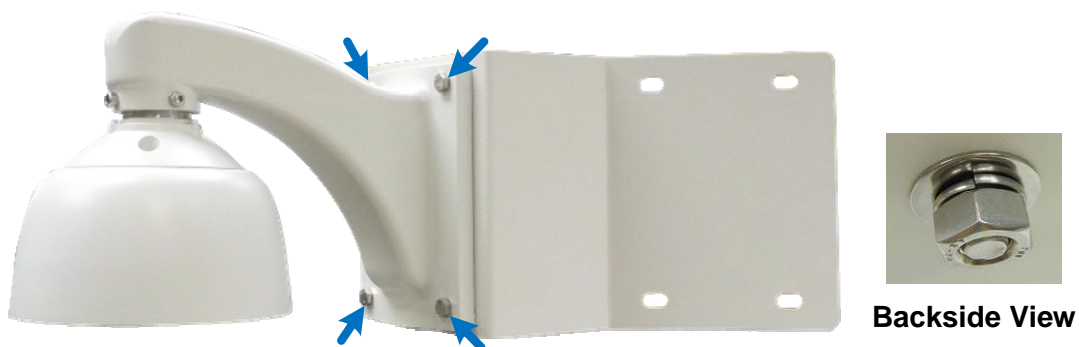

6. Thread the wires into the camera. See steps 1 to 4 in *Installation, Vandal Proof IP Dome (Part II)* Chapter, *GV-IPCam H.264 User's Manual* on the software CD.
7. Secure the camera to the back plate with the supplied torx wrench.

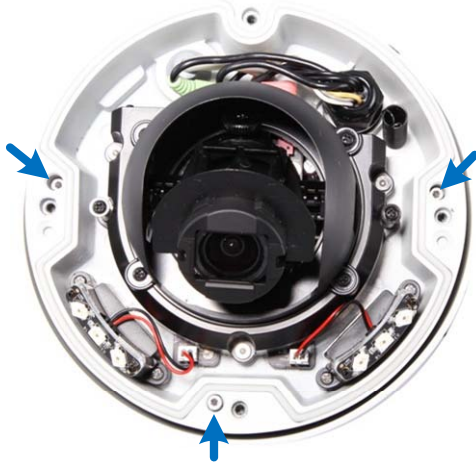

8. Connect the camera wires with wires from the wall.
9. Secure the plates to the wall with 8 self-prepared screws.
10. Refer to the indicated sections of the **GV-IPCam H.264 User's Manual on the software CD** to:
  - A. Access live view. See *Accessing the Live View, Getting Started* Chapter.
  - B. Adjust the angle, focus and zoom of the camera. See step 8 in *Installation, Vandal Proof IP Dome (Part II)* Chapter.
  - C. Replace the silica gel bag and secure the housing cover. See step 9 in *Installation, Vandal Proof IP Dome (Part II)* Chapter.

## 3.8 Convex Corner Mount with Wall Bracket



---

**Required accessories:**

- GV-Mount300
- GV-Mount900

**The user needs to prepare:**

- Screws for wall x 8

- 
1. Assemble the mounting plates (GV-Mount300, No. 1), slide in the plain washer (GV-Mount300, No. 4), then the split washer (GV-Mount300, No. 5), and secure with the screw cap (GV-Mount300, No. 6).

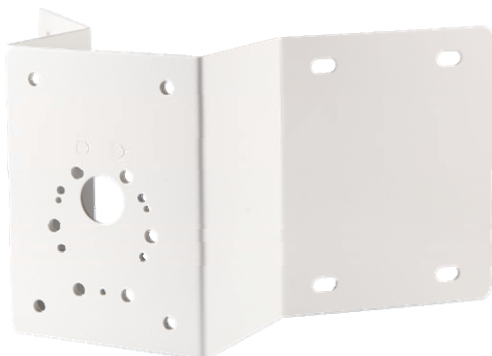

2. Secure the supplied back plate to wall mount bracket (GV-Mount900, No. 1).

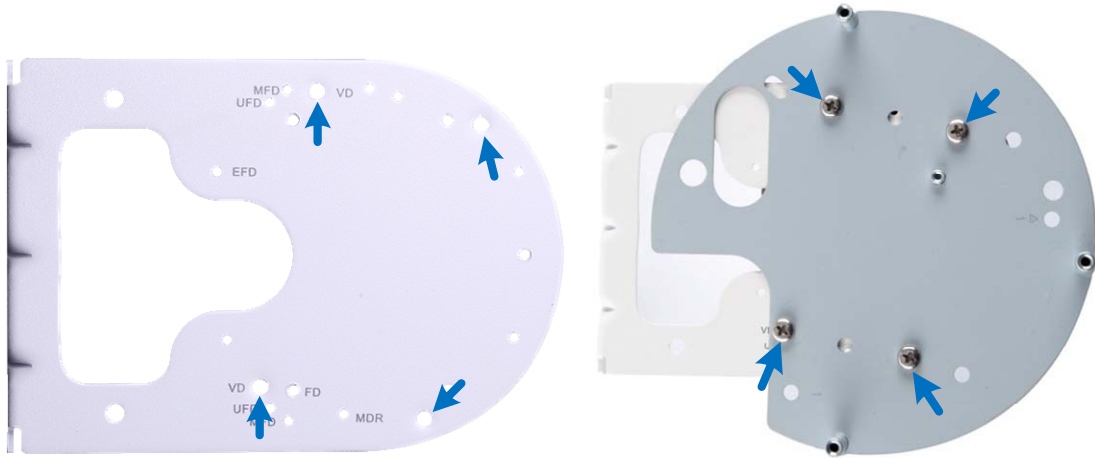

3. Secure the wall mount bracket to the mounting plates. Slide the 30 mm M8 screws (GV-Mount300, No. 2) from front and secure from the backside using plain washer (GV-Mount300, No. 4), split washer (GV-Mount300, No. 5) and screw cap (GV-Mount300, No. 6).



**Backside View**

4. Thread the power (supplied), network (self-prepared) and other wires (supplied) through the mounting plates, wall mount bracket and then into the camera. See steps 1 to 4 in *Installation, Vandal Proof IP Dome (Part II) Chapter, GV-IPCam H.264 User's Manual* on the software CD.

### 3 Installing the Vandal Proof IP Dome (Part II)

5. Secure the camera to the wall mount bracket with the supplied torx wrench.

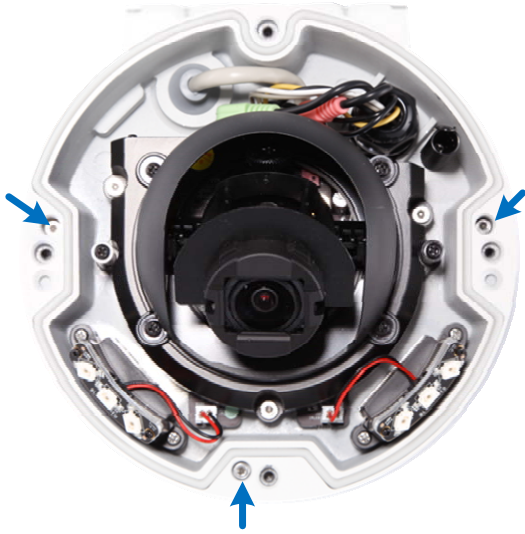

6. Connect camera wires with wires from the wall.
7. Secure the plates to the wall with 8 self-prepared screws.
8. Refer to the indicated sections of the **GV-IPCam H.264 User's Manual on the software CD** to:
  - A. Access live view. See *Accessing the Live View, Getting Started* Chapter.
  - B. Adjust the angle, focus and zoom of the camera. See step 8 in *Installation, Vandal Proof IP Dome (Part II)* Chapter.
  - C. Replace the silica gel bag and secure the housing cover. See step 9 in *Installation, Vandal Proof IP Dome (Part II)* Chapter.

---

**Note:** You can use a corrugated tube to waterproof the cable.

---

## 3.9 Convex Corner Box Mount



---

### Required accessories:

- GV-Mount203
- GV-Mount300
- GV-Mount903

### The user needs to prepare:

- Screws for wall x 8
- Corrugated tube (3/4",  $\varnothing$  26.0 ~ 26.5 mm)



- 
1. Assemble the mounting plates, slide in the plain washer (GV-Mount300, No. 4), then the split washer (GV-Mount300, No. 5), and secure with the screw cap (GV-Mount300, No. 6).

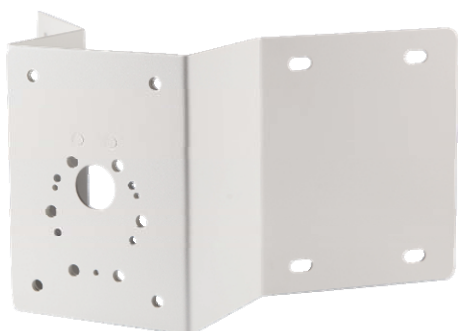

### 3 Installing the Vandal Proof IP Dome (Part II)

- Secure the junction box (GV-Mount203, No. 1) to the plate from the backside using the 25 mm M8 screw (GV-Mount300, No. 3), plain washer (GV-Mount300, No. 4) and split washer (GV-Mount300, No. 5).

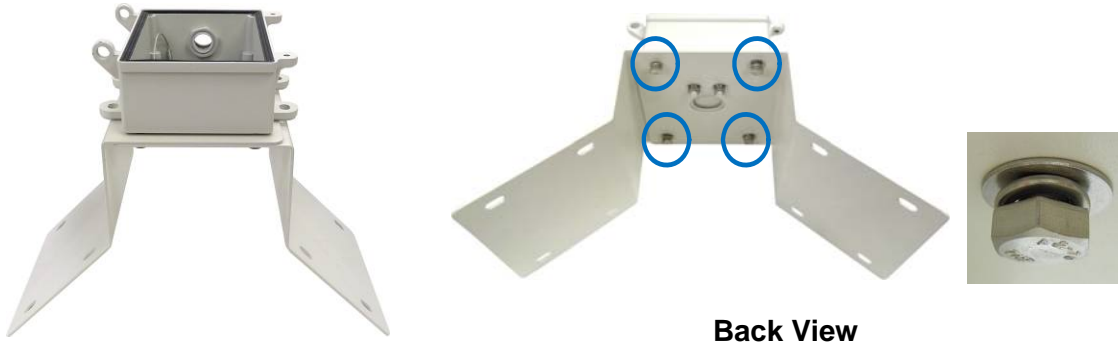

- Install the corrugated tube and the tube connector (GV-Mount203, No. 4) to the junction box.

- Dismantle the supplied corrugated tube connector. You should have 4 parts.



- Slide part A and part B to the self-prepared corrugated tube.

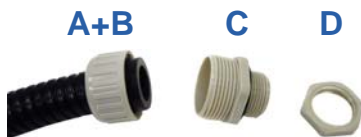

- Screw part C to the tube.
- Thread the necessary wires through the corrugated tube, plug the tube to the junction box and secure with part D.

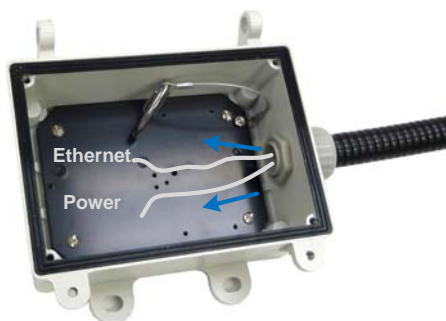

- Secure the mounting plates to the wall with self-prepared screws.

5. Assemble the pendant tube (GV-Mount203, No. 2), housing cap (GV-Mount903, No. 2) and the dome housing (GV-Mount903, No. 1) with M6 screws (GV-Mount903, No. 4).

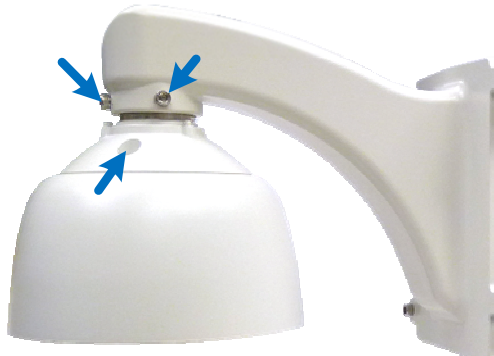

6. Thread the power (supplied), network (self-prepared) and other wires (supplied) through the pendant tube and into the dome housing.
7. Secure the supplied back plate to the dome housing.



8. Thread the wires into the camera. See steps 1 to 4 in *Installation, Vandal Proof IP Dome (Part II)* Chapter, *GV-IPCam H.264 User's Manual* on the software CD.
9. Secure the camera to the back plate with the supplied torx wrench.





### 3 Installing the Vandal Proof IP Dome (Part II)

10. Hinge and hook the pendant tube to the junction box.



11. Connect the wires and close the junction box with M5 screws (GV-Mount203, No. 3).

12. Refer to the indicated sections of the **GV-IPCam H.264 User's Manual on the software CD** to:

- A. Access live view. See *Accessing the Live View, Getting Started* Chapter.
- B. Adjust the angle, focus and zoom of the camera. See step 8 in *Installation, Vandal Proof IP Dome (Part II)* Chapter.
- C. Replace the silica gel bag and secure the housing cover. See step 9 in *Installation, Vandal Proof IP Dome (Part II)* Chapter.

## 3.10 Concave Corner Mount with Pendant Tube

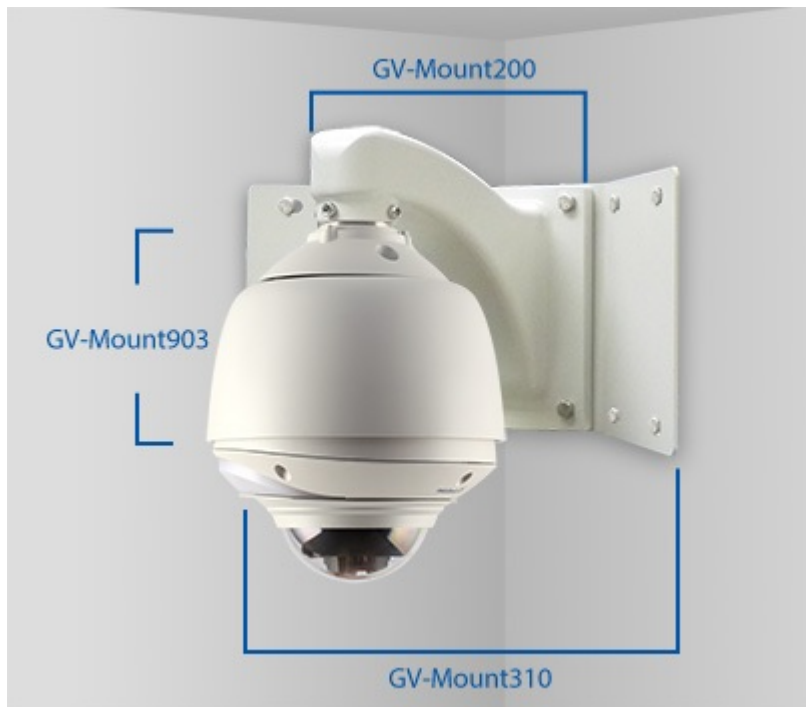

---

**Required accessories:**

- GV-Mount200
- GV-Mount310
- GV-Mount903

**The user needs to prepare:**

- Screws for wall x 8
-

### 3 Installing the Vandal Proof IP Dome (Part II)

1. Assemble the mounting plates (GV-Mount310, No. 1). Slide in the plain washer (GV-Mount310, No. 4), then the split washer (GV-Mount310, No. 5), and secure with the screw cap (GV-Mount310, No. 6).



2. Assemble the pendant tube (GV-Mount200, No. 1) with the housing cap (GV-Mount903, No. 2) and then the dome housing (GV-Mount903, No. 1) with M6 screws (GV-Mount903, No. 4).



3. Thread the power (supplied), network (self-prepared) and other wires (supplied) through the pendant tube and the dome housing.
4. Secure the supplied back plate to the dome housing.



5. Secure the pendant tube to the mounting plates. Slide the 30 mm M8 screws (GV-Mount310, No. 3) from front and secure from the backside using plain washer (GV-Mount310, No. 4), split washer (GV-Mount310, No. 5) and screw cap (GV-Mount310, No. 6).

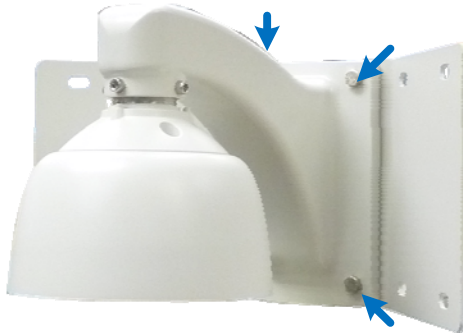

**Front View**



**Back View**

6. Connect these wires to the camera. See steps 1 to 4 in *Installation, Vandal Proof IP Dome (Part II) Chapter, GV-IPCam H.264 User's Manual* on the software CD.
7. Secure the camera to the back plate with the supplied torx wrench.

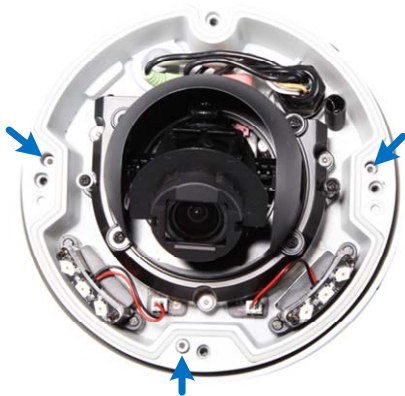

8. Connect the camera wires with wires from the wall.
9. Secure the plates to the wall with 8 self-prepared screws.
10. Refer to the indicated sections of the **GV-IPCam H.264 User's Manual on the software CD** to:
  - A. Access live view. See *Accessing the Live View, Getting Started Chapter*.
  - B. Adjust the angle, focus and zoom of the camera. See step 8 in *Installation, Vandal Proof IP Dome (Part II) Chapter*.
  - C. Replace the silica gel bag and secure the housing cover. See step 9 in *Installation, Vandal Proof IP Dome (Part II) Chapter*.

## 3.11 Concave Corner Mount with Wall Bracket

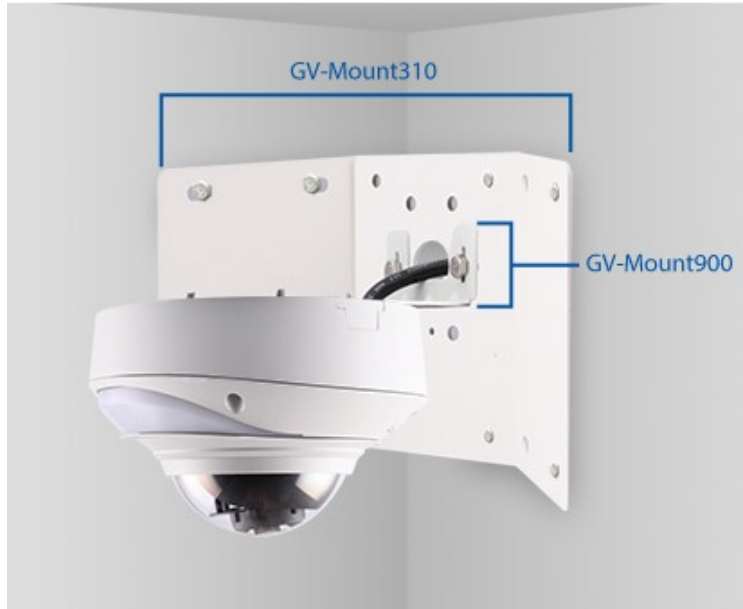

---

**Required accessories:**

- GV-Mount310
- GV-Mount900

**The user needs to prepare:**

- Screws for wall x 8
- 

1. Assemble the mounting plates (GV-Mount310, No. 1), slide in the plain washer (GV-Mount310, No. 3), then the split washer (GV-Mount310, No. 4), and secure them with the screw cap (GV-Mount310, No. 5).

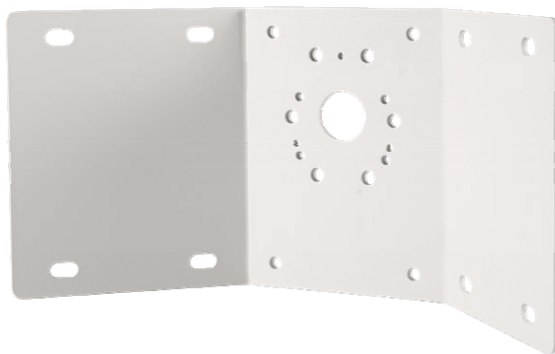

- Secure the supplied back plate to wall mount bracket (GV-Mount900, No. 1).

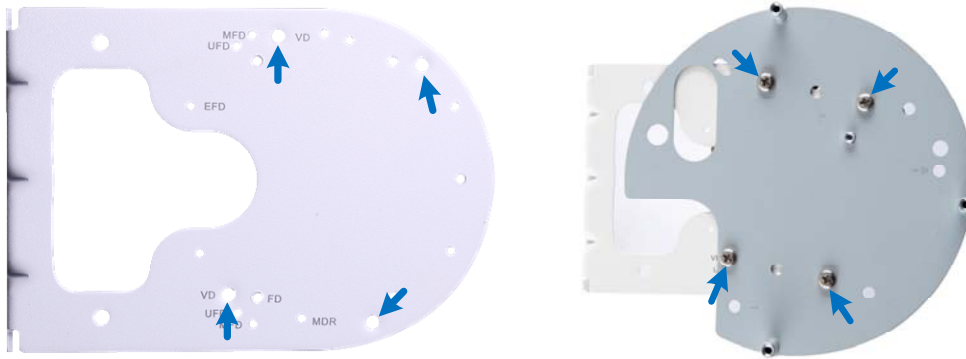

- Secure the wall mount bracket to the mounting plates. Slide the 30 mm M8 screws (GV-Mount310, No. 2) from the front and secure from the backside using plain washer (GV-Mount310, No. 3), split washer, (GV-Mount310, No. 4) and M8 screw cap (GV-Mount310, No. 5).



**Front View**



**Back View**

- Thread the power (supplied), network (self-prepared) and other wires (supplied) through the mounting plates, wall mount bracket and then into the camera. See steps 1 to 4 in *Installation, Vandal Proof IP Dome (Part II) Chapter, GV-IPCam H.264 User's Manual* on the software CD.
- Secure the camera to the wall mount bracket with the supplied torx wrench.

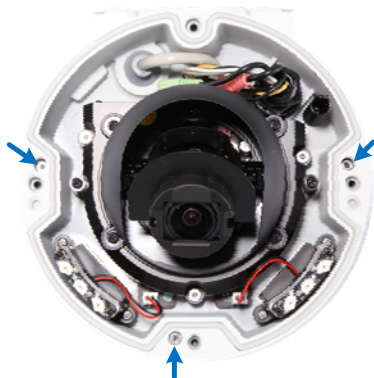

### 3 Installing the Vandal Proof IP Dome (Part II)

6. Connect the camera wires with wires from the wall.
7. Secure the plates to the wall with 8 self-prepared screws.
8. Refer to the indicated sections of the **GV-IPCam H.264 User's Manual on the software CD** to:
  - A. Access live view. See *Accessing the Live View, Getting Started* Chapter.
  - B. Adjust the angle, focus and zoom of the camera. See step 8 in *Installation, Vandal Proof IP Dome (Part II)* Chapter.
  - C. Replace the silica gel bag and secure the housing cover. See step 9 in *Installation, Vandal Proof IP Dome (Part II)* Chapter.

---

**Note:** You can use a corrugated tube to waterproof the cable.

---

## 3.12 Pole Mount with Pendant Tube



---

### Required accessories:

- GV-Mount200
  - GV-Mount400 or GV-Mount410
  - GV-Mount903
- 

1. Assemble the pendant tube with housing cap (GV-Mount903, No. 2) and then the dome housing (GV-Mount903, No. 1) with M6 screws (GV-Mount903, No. 4).





### 3 Installing the Vandal Proof IP Dome (Part II)

2. Secure the pendant tube (GV-Mount200, No. 1) with the mounting bracket (GV-Mount400 / 401, No. 1). Slide the 30 mm M8 screws (GV-Mount400 / GV-Mount410, No. 3) from the front and secure from the backside using plain washer (GV-Mount400 / GV-Mount410, No. 5), split washer (GV-Mount400 / GV-Mount410, No. 6) and screw cap (GV-Mount400 / GV-Mount410, No. 7).



**Backside View**

3. Thread the power (supplied), network (self-prepared) and other wires (supplied) through the mounting bracket, pendant tube and the dome housing.
4. Secure the supplied back plate to the dome housing.



5. Thread the wires into the camera. See steps 1 to 4 in *Installation, Vandal Proof IP Dome (Part II)* Chapter, *GV-IPCam H.264 User's Manual* on the software CD.

6. Secure the camera to the back plate with the supplied torx wrench.

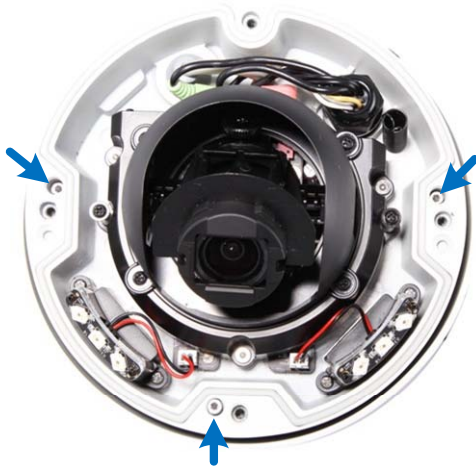

7. Connect camera wires with wires from the pole.
8. Secure the mounting bracket to the pole using 3 steel straps (GV-Mount400 / GV-Mount410, No. 2). Rotate the screw on the strap to adjust its size.



9. Refer to the indicated sections of the **GV-IPCam H.264 User's Manual on the software CD** to:
  - A. Access live view. See *Accessing the Live View, Getting Started* Chapter.
  - B. Adjust the angle, focus and zoom of the camera. See step 8 in *Installation, Vandal Proof IP Dome (Part II)* Chapter.
  - C. Replace the silica gel bag and secure the housing cover. See step 9 in *Installation, Vandal Proof IP Dome (Part II)* Chapter.

### 3.13 Pole Mount with Wall Bracket



---

**Required accessories:**

- GV-Mount400 or GV-Mount410
  - GV-Mount900
- 

1. Secure the supplied back plate to wall mount bracket (GV-Mount900, No. 1).

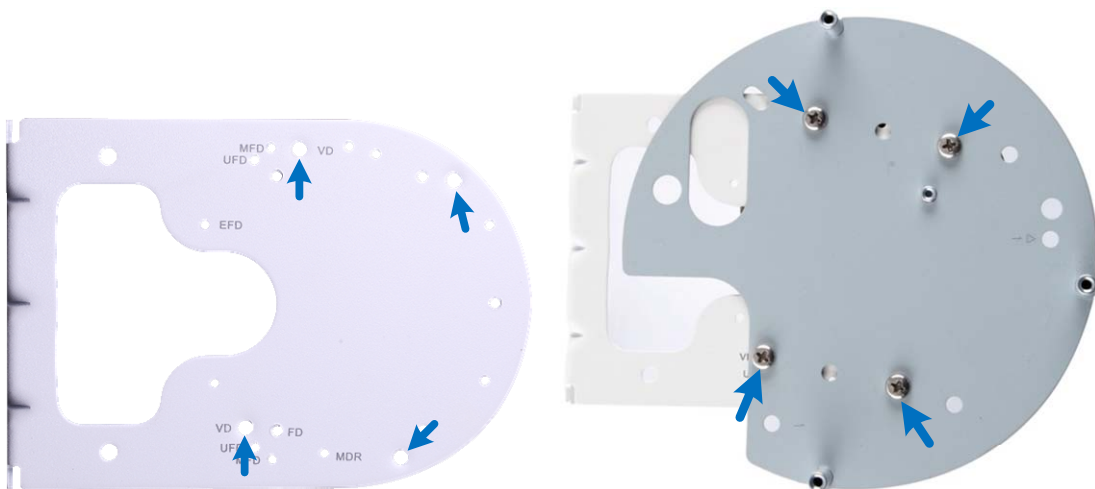

2. Secure the wall mount bracket (GV-Mount900, No. 1) to the mounting bracket (GV-Mount400 / GV-Mount410, No.1). Slide the 30 mm M8 screws (GV-Mount400 / GV-Mount410, No. 3) from the front and secure from the backside using plain washer (GV-Mount400 / GV-Mount410, No. 5), split washer, (GV-Mount400 / GV-Mount410, No. 6) and M8 screw cap (GV-Mount400 / GV-Mount410, No. 7).

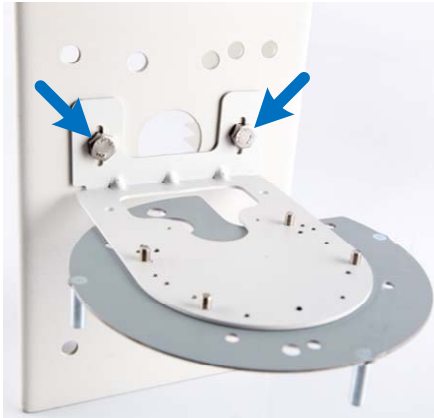

**Backside View**

3. Thread the power (supplied), network (self-prepared) and other wires (supplied) through the mounting bracket, wall mount bracket and then into the camera. See steps 1 to 4 in *Installation, Vandal Proof IP Dome (Part II) Chapter, GV-IPCam H.264 User's Manual* on the software CD.
4. Secure the camera to the back plate with the supplied torx wrench.

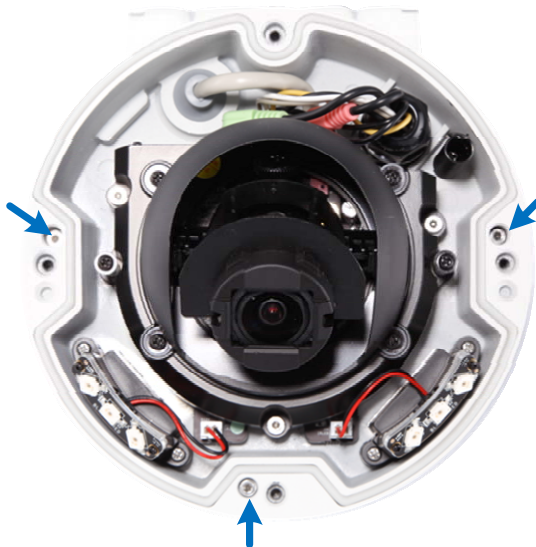

### 3 Installing the Vandal Proof IP Dome (Part II)

5. Connect the camera wires with wires from the pole.
6. Secure the mounting bracket to the pole using 3 steel straps (GV-Mount400 / GV-Mount410, No. 2). Rotate the screw on the strap to adjust its size.



7. Refer to the indicated sections of the **GV-IPCam H.264 User's Manual on the software CD** to:
  - A. Access live view. See *Accessing the Live View, Getting Started* Chapter.
  - B. Adjust the angle, focus and zoom of the camera. See step 8 in *Installation, Vandal Proof IP Dome (Part II)* Chapter.
  - C. Replace the silica gel bag and secure the housing cover. See step 9 in *Installation, Vandal Proof IP Dome (Part II)* Chapter.

## 3.14 Pole Box Mount

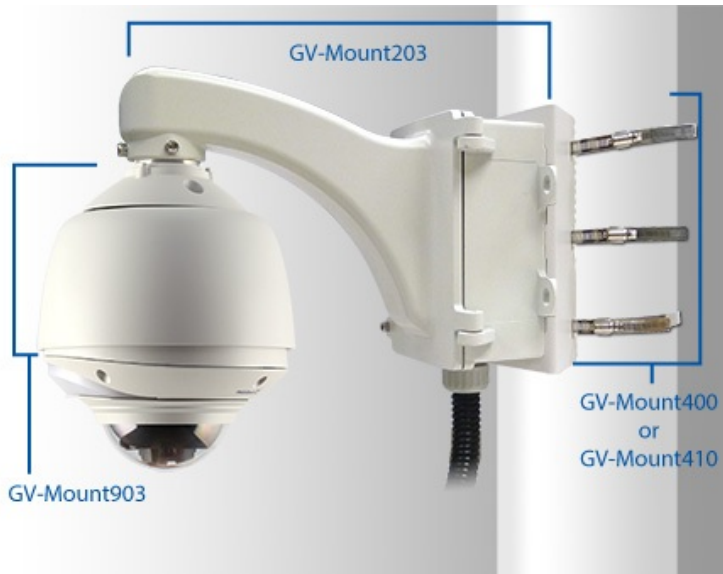

---

### Required accessories:

- GV-Mount203
- GV-Mount400 or GV-Mount410
- GV-Mount903

### The user needs to prepare:

- Corrugated tube x 1 (3/4",  $\varnothing$  26.0 ~ 26.5 mm)



- 
1. Assemble the junction box (GV-Mount203, No. 1) with the mounting bracket (GV-Mount400 / 410, No. 1) with the plain washer (GV-Mount400 / GV-Mount410, No. 5), split washers (GV-Mount400 / GV-Mount410, No. 6) and then the 25 mm M8 screws (GV-Mount400 / GV-Mount410, No. 4).



**Backside View**

### 3 Installing the Vandal Proof IP Dome (Part II)

2. Secure the mounting bracket to the pole using 3 steel straps (GV-Mount400 / GV-Mount410, No. 2). Rotate the screw on the strap to adjust its size. Face the conduit exit downward.



3. Install the corrugated tube and the tube connector (GV-Mount203, No. 4) to the junction box.
  - A. Dismantle the supplied corrugated tube connector. You should have 4 parts.



- B. Slide part A and part B to the self-prepared corrugated tube.

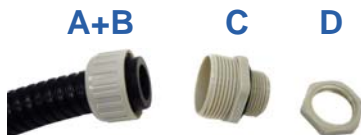

- C. Screw part C to the tube.
- D. Thread the necessary wires through the corrugated tube, plug the tube to the junction box and secure with part D.

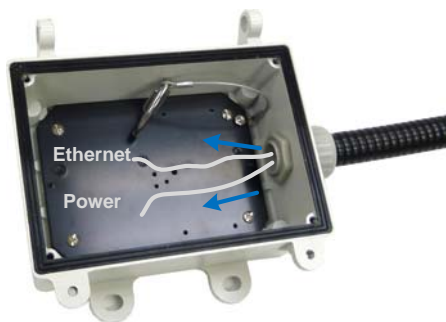

4. Assemble the pendant tube (GV-Mount203, No. 2), housing cap (GV-Mount903, No. 2) and the dome housing (GV-Mount903, No. 1) with M6 screws (GV-Mount903, No. 4).

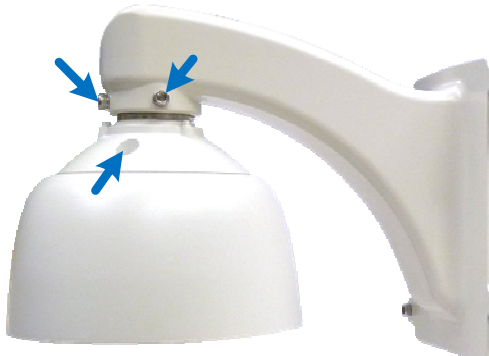

5. Thread the power (supplied), network (self-prepared) and other wires (supplied) through the pendant tube and into the dome housing
6. Secure the supplied back plate to the dome housing.



7. Thread the wires into the camera. See steps 1 to 4 in *Installation, Vandal Proof IP Dome (Part II) Chapter, GV-IPCam H.264 User's Manual* on the software CD.
8. Secure the camera to the back plate with the supplied torx wrench.

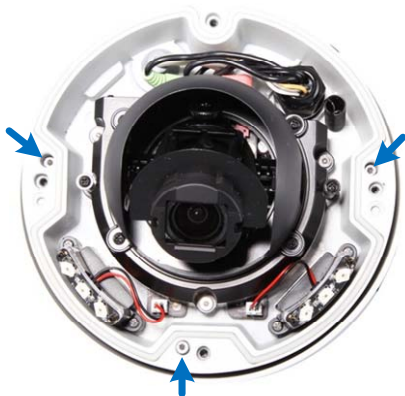



### 3 Installing the Vandal Proof IP Dome (Part II)

9. Hinge and hook the pendant tube to the junction box.



10. Connect the wires and close the junction box with M5 screws (GV-Mount203, No. 3) with the torx wrench (GV-Mount203, No. 5)
11. Refer to the indicated sections of the **GV-IPCam H.264 User's Manual on the software CD** to:
  - A. Access live view. See *Accessing the Live View, Getting Started* Chapter.
  - B. Adjust the angle, focus and zoom of the camera. See step 8 in *Installation, Vandal Proof IP Dome (Part II)* Chapter.
  - C. Replace the silica gel bag and secure the housing cover. See step 9 in *Installation, Vandal Proof IP Dome (Part II)* Chapter.

## 3.15 Power Box Mount



---

### The user needs to prepare

- Screws for securing the camera to power box
- 

Supported Power Box Types			
Single Gang	Double Gang	4" Octagon	4" Square
	✓		✓

1. Thread the power (supplied), network (self-prepared) and other wires (supplied) through the power box and the supplied back plate and then secure the back plate to the power box with self-prepared screws.



### 3 Installing the Vandal Proof IP Dome (Part II)

2. Thread the wires into the camera. See steps 1 to 4 in *Installation, Vandal Proof IP Dome (Part II)* Chapter, *GV-IPCam H.264 User's Manual* on the software CD.
3. Secure the camera to the back plate with the supplied torx wrench.

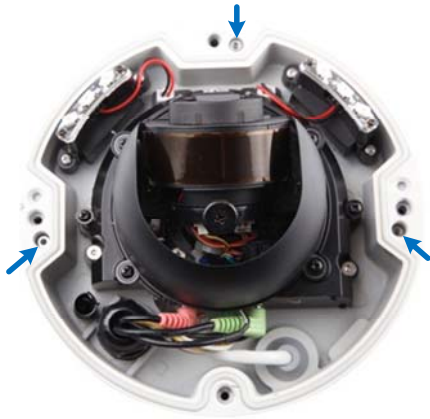

4. Refer to the indicated sections of the **GV-IPCam H.264 User's Manual on the software CD** to:
  - A. Access live view. See *Accessing the Live View, Getting Started* Chapter.
  - B. Adjust the angle, focus and zoom of the camera. See step 8 in *Installation, Vandal Proof IP Dome (Part II)* Chapter.
  - C. Replace the silica gel bag and secure the housing cover. See step 9 in *Installation, Vandal Proof IP Dome (Part II)* Chapter.

# 4. Installing the Fixed IP Dome

## 4.1 Basic Installation

### 4.1.1 Assembling the Fixed IP Dome with the Dome Housing



---

**Required accessories:**

- GV-Mount902
- 

1. Unpack the camera package and remove the camera body.



## 4 Installing the Fixed IP Dome

2. Secure the camera body to the housing plate (GV-Mount902, No. 6) with 3 small screws (GV-Mount902, No. 7).



3. Secure the plate to the dome housing with M4 screws (GV-Mount902, No. 3).



4. Secure the housing cap and the dome housing with M6 screws (GV-Mount902, No. 4).



## 4.1.2 Putting on the Housing Cover

1. Secure the right and left rack (GV-Mount902, No. 5) to the housing cover.



2. Secure the housing cover to the camera with M4 screws (GV-Mount902, No. 3).



## 4.2 Straight Tube Box Mount

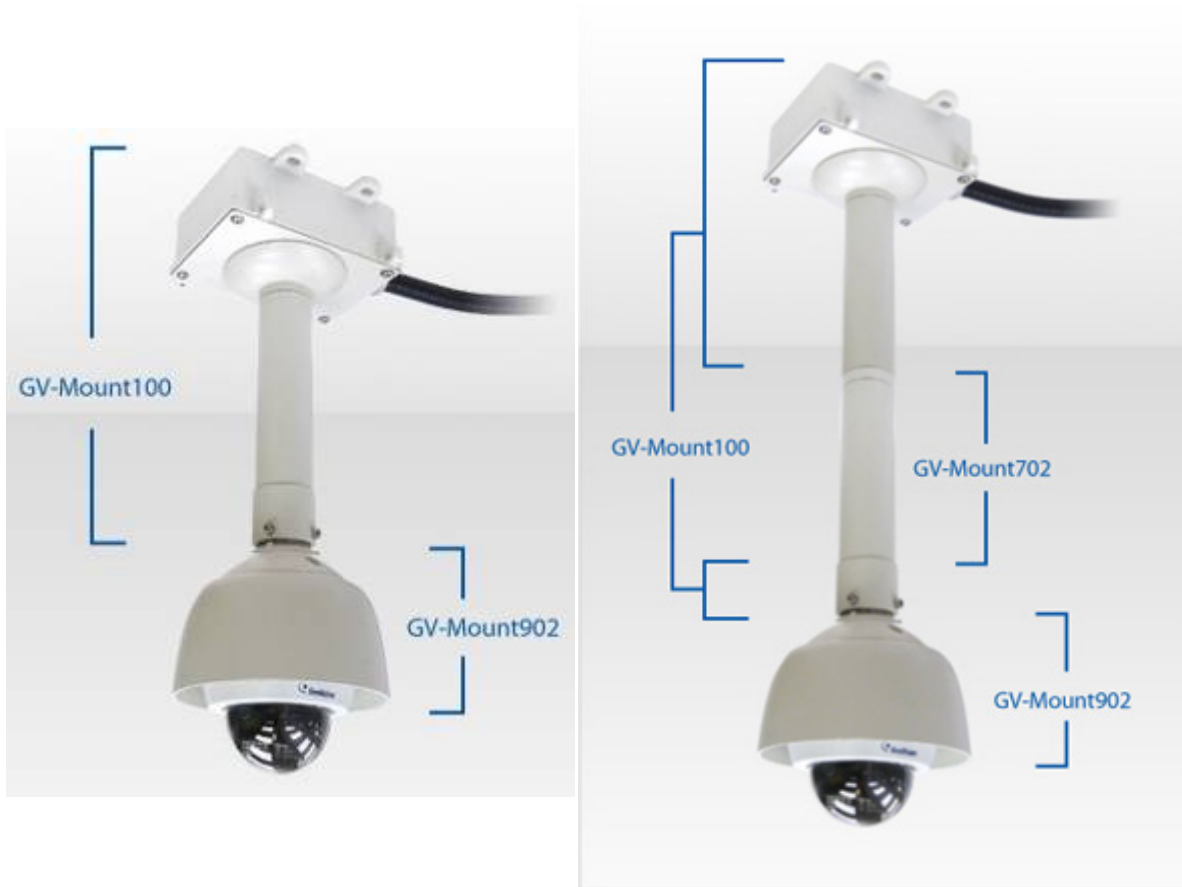

---

**Required accessories:**

- GV-Mount100
- GV-Mount902

**The user needs to prepare:**

- Screws for ceiling x 4
- Corrugated tube x 1 (3/4",  $\varnothing$  26.0 ~ 26.5 mm)



**Optionally extend with:**

- GV-Mount702
-

1. Assemble the camera with the dome housing. See *4.1.1 Assembling the Fixed IP Dome with the Dome Housing*.
2. Secure the junction box (GV-Mount100, No. 1) to the ceiling with 4 self-prepared screws.



3. Assemble the corrugated tube connector (GV-Mount100, No. 6) with the self-prepared corrugated tube.

A. Dismantle the supplied corrugated tube connector. You should have 4 parts.



B. Slide part A and part B to the self-prepared corrugated tube.

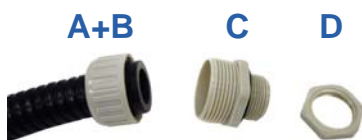

C. Screw part C to the tube.

D. Thread the necessary wires and cables through the corrugated tube, plug the tube to the junction box and secure with part D.

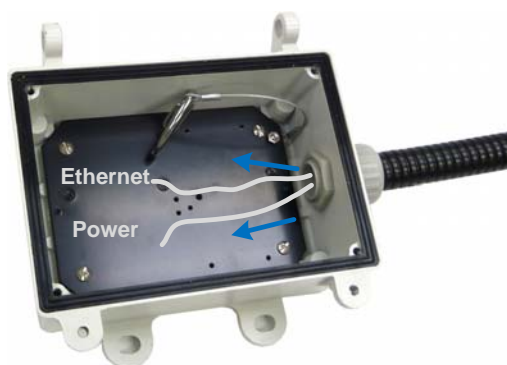



## 4 Installing the Fixed IP Dome

4. Thread the wires and cables through the box cover (GV-Mount100, No. 2), hook the box cover and secure it with M5 flat screws (GV-Mount100, No. 5).



5. Assemble the tube (GV-Mount100, No. 3) and the tube connector (GV-Mount100, No. 4).



6. Thread the wires and cables through the tube, assemble the tube to the box cover and tighten the torxes with the supplied torx wrench (GV-Mount100, No. 7).

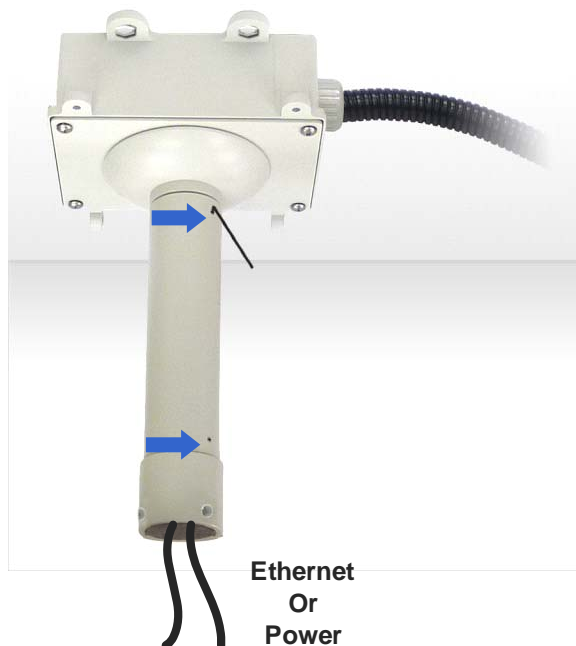

7. Thread the wires and cables through the housing cap (GV-Mount902, No. 2) and secure the tube to the end of the housing cap with M6 screws (GV-Mount902, No. 4).
8. Connect the network, power and other cables to the camera. See *Connecting the Camera, Fixed IP Dome* Chapter, *GV-IPCam H.264 User's Manual* on the software CD.
9. Adjust the angle, focus and zoom of the camera. See steps 6 and 7 in *Hard-Ceiling Mount, Fixed IP Dome* Chapter, *GV-IPCam H.264 User's Manual* on the software CD:
10. Put on the housing cover. See *4.1.2 Putting on the Housing Cover*.

## 4.3 Straight Tube Mount



---

**Required accessories:**

- GV-Mount101
- GV-Mount902

**The user needs to prepare:**

- Screws for ceiling x 4

**Optionally extend with:**

- GV-Mount702
-

1. Assemble the camera with the dome housing. See *4.1.1 Assembling the Fixed IP Dome with the Dome Housing*.
2. Thread the necessary cables and wires from the ceiling through the mounting bracket (GV-Mount101, No. 1) and secure the bracket to the ceiling with 4 self-prepared screws.



3. Assemble the tube (GV-Mount101, No. 2) and the tube connector (GV-Mount101, No. 3).



4. Thread the cables and wires into the tube, assemble the tube to the pendant mount bracket and tighten the torxes with the supplied torx wrench (GV-Mount101, No. 4).



5. Thread the cables and wires into the dome housing and connect the network, power and other cables. See *Connecting the Camera, Fixed IP Dome Chapter, GV-IPCam H.264 User's Manual* on the software CD.

6. Secure the tube to the end of the housing cap (GV-Mount902, No. 2) with M6 screws (GV-Mount101, No. 4).



7. Refer to the indicated sections of the **GV-IPCam H.264 User's Manual on the software CD** to:
  - A. Access the live view. See *Accessing the Live View, Getting Started* Chapter.
  - B. Follow steps 6 and 7 in *Hard-Ceiling Mount, Fixed IP Dome* Chapter to adjust the angle, focus and zoom of the camera.
8. Put on the housing cover. See *4.1.2 Putting on the Housing Cover*.

## 4.4 Wall Mount



---

### Required accessories:

- GV-Mount205
- 

1. Take the wall mount bracket (GV-Mount205, No. 1) and make 4 marks on the wall for screw anchors.



2. Drill the marks and insert 4 screw anchors (GV-Mount205, No. 6).
3. Align and secure the mounting plate (GV-Mount205, No. 2) to the wall mount bracket with 4 M4 screws (GV-Mount205, No. 4).

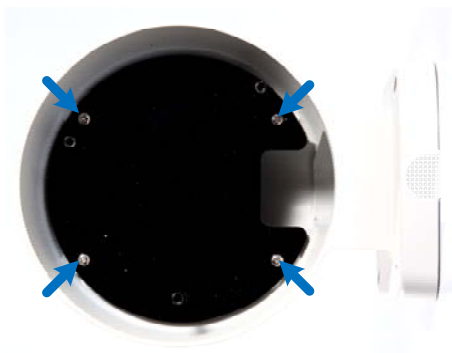

## 4 Installing the Fixed IP Dome

- Align and secure the housing plate (GV-Mount205, No. 3) to the mounting plate with 3 M4 screws (GV-Mount205, No. 4).

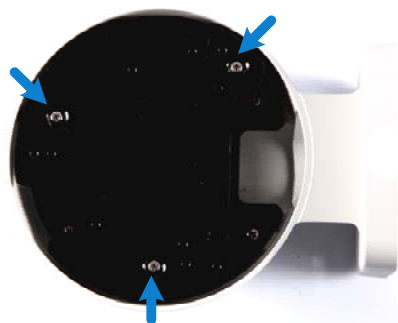

- Unpack and remove the camera cover with supplied torx wrench.



- Align and secure the camera body to the housing plate with 3 M4 screws (GV-Mount205, No. 4).

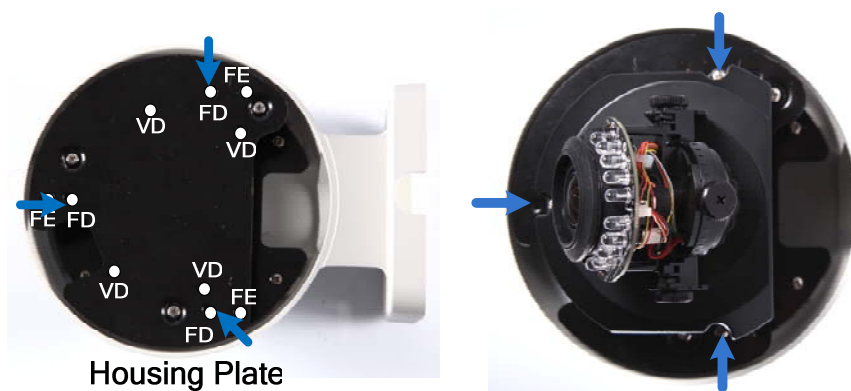

Housing Plate

7. Thread the camera cables through the wall mount bracket.

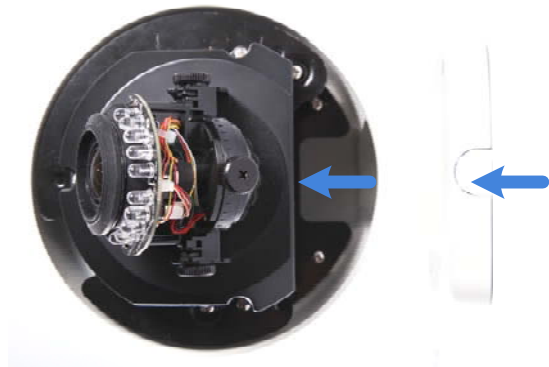

8. Secure the wall mount bracket to the wall with 40 mm M4 screws (GV-Mount205, No. 5) and plain washers (GV-Mount205, No. 7).
9. Refer to the indicated sections of the **GV-IPCam H.264 User's Manual on the software CD** to:
  - A. Connect the network, power and other cables to the camera. See *Connecting the Camera, Fixed IP Dome* Chapter.
  - B. Access the live view. See *Accessing the Live View, Getting Started* Chapter.
  - C. Adjust the angle, focus and zoom, and secure the housing cover. See steps 6 to 8 in *Hard-Ceiling Mount, Fixed IP Dome* Chapter.



## 4.5 L-Shaped Wall Mount



---

### Required accessories:

- GV-Mount900
- 

1. Unpack and remove the camera cover with the supplied torx wrench.



2. Take the wall mount bracket (GV-Mount900, No. 1) and make 2 marks on the wall for screw anchors.

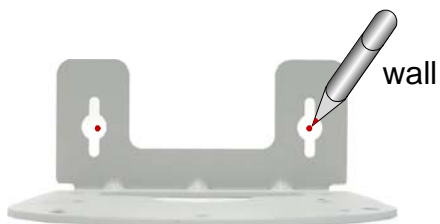

3. Drill the marks and insert 2 screw anchors (GV-Mount900, No. 2).

4. Insert the wall mount screws (GV-Mount900, No. 3) and leave enough distance (approximately 2 mm) to hang the wall mount bracket later.

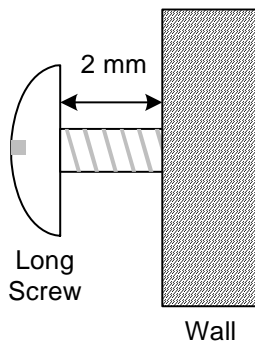

5. Align and secure the camera body with the wall mount bracket with three M3 screws (GV-Mount900, No. 4).

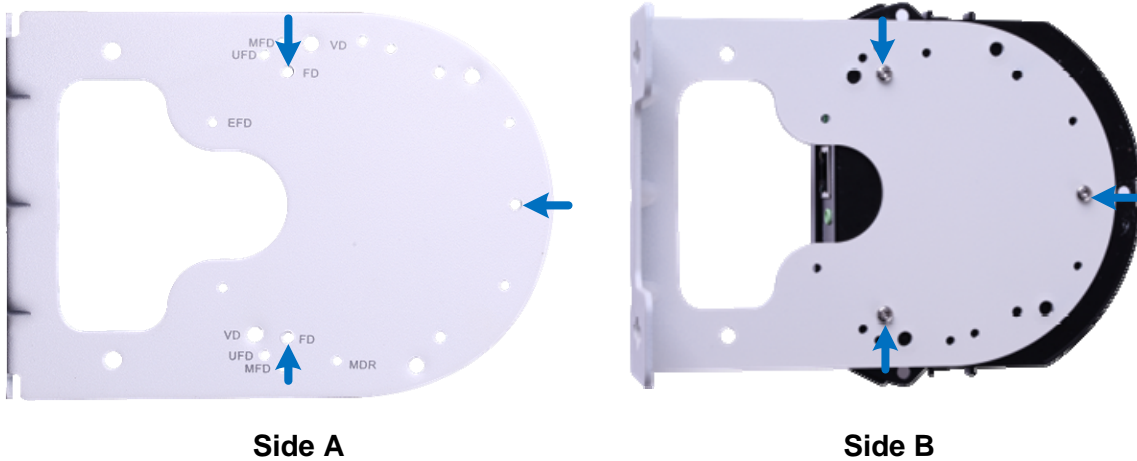

6. Hang the wall mount bracket on the wall mount screws and push the wall mount bracket downward. Tighten the wall mount screws to the wall.

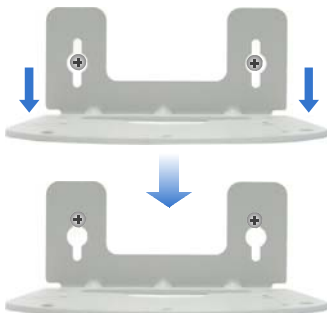

7. Refer to the indicated sections of the **GV-IPCam H.264 User's Manual on the software CD** to:
  - A. Connect the network, power and other cables to the camera. See *Connecting the Camera, Fixed IP Dome* Chapter.
  - B. Access the live view. See *Accessing the Live View, Getting Started* Chapter.
  - C. Adjust the angle, focus and zoom, and secure the housing cover. See steps 6 to 8 in *Hard-Ceiling Mount, Fixed IP Dome* Chapter.

## 4.6 Wall Box Mount



---

### Required accessories:

- GV-Mount909
- 

1. Take the wall mount bracket (GV-Mount909, No. 1) and make 4 marks on the wall for screw anchors.



2. Drill the marks and insert screw anchors (GV-Mount909, No. 2).
3. Secure the wall mount bracket to the wall with wall mount screws (GV-Mount909, No. 3).

## 4 Installing the Fixed IP Dome

4. Unpack and remove the camera cover with the supplied torx wrench.



5. Align and secure the camera body to the wall mount bracket with three M3 screws (GV-Mount909, No. 4).

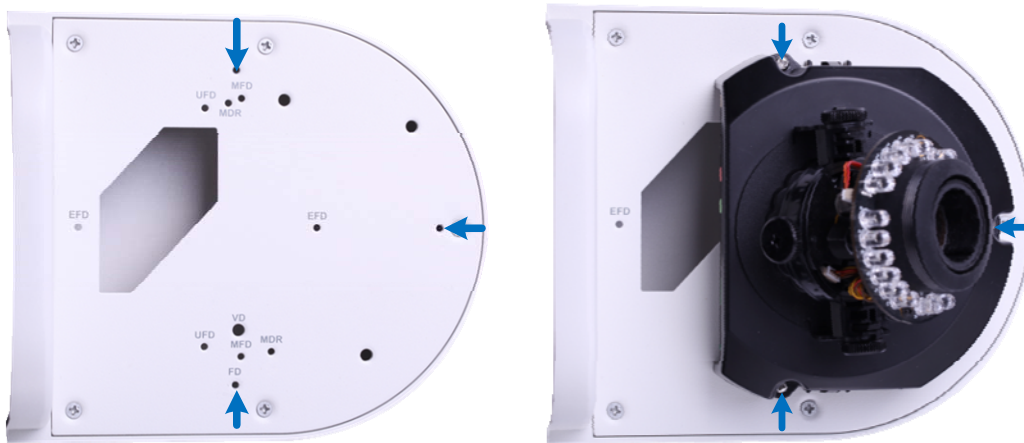

6. Refer to the indicated sections of the **GV-IPCam H.264 User's Manual on the software CD** to:
  - A. Connect the network, power and other cables to the camera. See *Connecting the Camera, Fixed IP Dome* Chapter.
  - B. Access the live view. See *Accessing the Live View, Getting Started* Chapter.
  - C. Adjust the angle, focus and zoom, and secure the housing cover. See steps 6 to 8 in *Hard-Ceiling Mount, Fixed IP Dome* Chapter.

## 4.7 Wall Pendant Mount



---

**Required accessories:**

- GV-Mount200
- GV-Mount902

**The user needs to prepare:**

- Screws for wall x 4
- 

1. Assemble the camera with the dome housing. See *4.1.1 Assembling the Fixed IP Dome with the Dome Housing*.
2. On the installation site, thread the necessary cables and wires from the wall through the pendant tube (GV-Mount200, No. 1), and secure the tube to the wall with 4 screws of your choice.



## 4 Installing the Fixed IP Dome

3. Thread the cables and wires into the dome housing and secure the pendant tube to the end of the housing cap (GV-Mount902, No. 2) with M6 screws (GV-Mount902, No. 4).



4. Refer to the indicated sections of the **GV-IPCam H.264 User's Manual on the software CD** to:
  - A. Connect the network, power and other cables to the camera. See *Connecting the Camera, Fixed IP Dome* Chapter.
  - B. Access the live view. See *Accessing the Live View, Getting Started* Chapter.
  - C. Adjust the angle, focus and zoom. See steps 6 and 7 in *Hard-Ceiling Mount, Fixed IP Dome* Chapter.
5. Put on the housing cover. See *4.1.2 Putting on the Housing Cover*.

## 4.8 Convex Corner Mount



---

**Required accessories:**

- GV-Mount200
- GV-Mount300
- GV-Mount902

**The user needs to prepare:**

- Screws for wall x 8
- 

1. Assemble the camera with the dome housing. See *4.1.1 Assembling the Fixed IP Dome with the Dome Housing*.
2. Assemble the mounting plates (GV-Mount300, No. 1), slide in the plain washer (GV-Mount300, No. 4), then the split washer (GV-Mount300, No. 5), and secure them with the screw cap (GV-Mount300, No. 6).

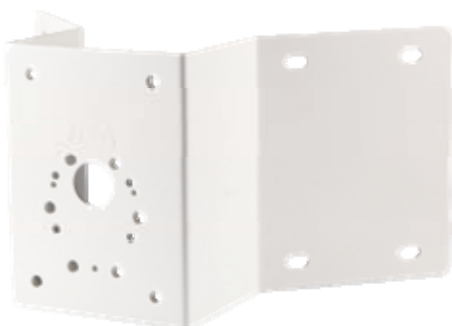



## 4 Installing the Fixed IP Dome

- Secure the pendant tube (GV-Mount200, No. 1) to the plate. Slide the 30 mm M8 screws (GV-Mount300, No. 2) from the front and secure from the backside using plain washers (GV-Mount300, No. 4), split washers (GV-Mount300, No. 5) and the M8 screw caps (GV-Mount300, No. 6).

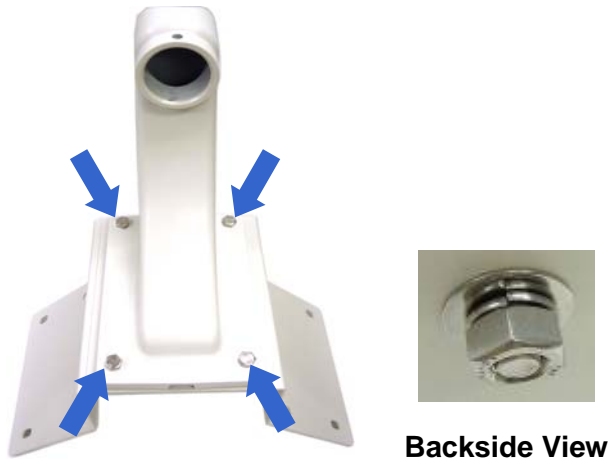

- Thread the necessary wires and cables through the pendant tube and secure the plate to the wall with 8 self-prepared screws.
- Thread the wires and cables into the dome and connect the network, power and other cables to the camera. See *Connecting the Camera, Fixed IP Dome Chapter, GV-IPCam H.264 User's Manual* on the software CD.
- Secure the pendant tube to the end of the housing cap (GV-Mount902, No. 2) with M6 screws (GV-Mount902, No. 4).
- Refer to the indicated sections of the **GV-IPCam H.264 User's Manual on the software CD** to:
  - Access the live view. See *Accessing the Live View, Getting Started Chapter*.
  - Adjust the angle, focus and zoom. See steps 6 and 7 in *Hard-Ceiling Mount, Fixed IP Dome Chapter*.
- Put on the housing cover. See *4.1.2 Putting on the Housing Cover*.

## 4.9 Convex Corner Box Mount



---

### Required accessories:

- GV-Mount203
- GV-Mount300
- GV-Mount902

### The user needs to prepare:

- Screws for wall x 8
- Corrugated tube x 1 (3/4",  $\varnothing$  26.0 ~ 26.5 mm)



## 4 Installing the Fixed IP Dome

1. Assemble the camera with the dome housing. See *4.1.1 Assembling the Fixed IP Dome with the Dome Housing*.
2. Assemble the mounting plates (GV-Mount300, No. 1), slide in the plain washer (GV-Mount300, No. 4), then the split washer (GV-Mount300, No. 5), and secure them with the screw cap (GV-Mount300, No. 6).

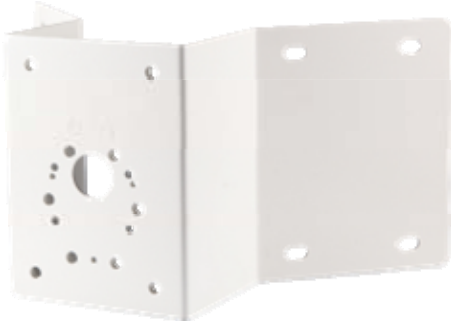

3. Secure the junction box (GV-Mount203, No. 1) to the mounting plate from the back side using the 25 mm M8 screw (GV-Mount300, No. 3), plain washer (GV-Mount300, No. 4), split washer (GV-Mount300, No. 5) and the M8 screw cap (GV-Mount300, No. 6).

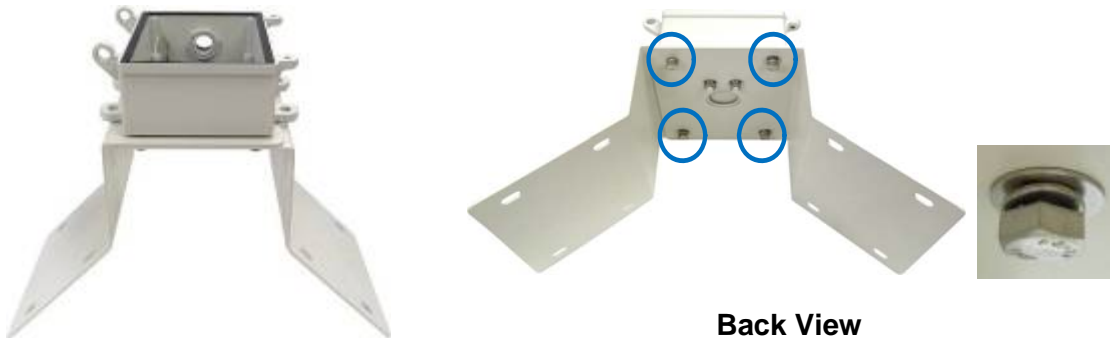

4. Secure the mounting plate to the wall with 8 self-prepared screws. Face the conduit exit downward.
5. Assemble the corrugated tube connector (GV-Mount203, No. 4) with the self-prepared corrugated tube.

- A. Dismantle the supplied corrugated tube connector. You should have 4 parts.



- B. Slide part A and part B to the self-prepared corrugated tube.

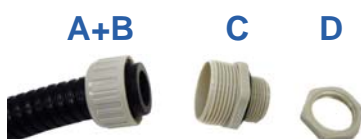

- C. Screw part C to the tube.

- D. Thread the necessary wires and cables through the corrugated tube, plug the tube to the box and secure with part D.

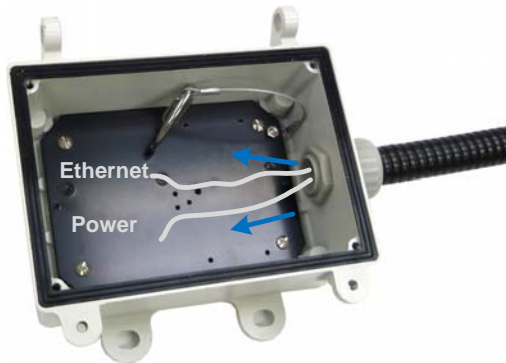

6. Hinge and hook the pendant tube (GV-Mount203, No. 2) to the junction box.



7. Thread the wires and cables through the pendant tube into the dome housing and connect them to the camera. See *Connecting the Camera, Fixed IP Dome* Chapter, *GV-IPCam H.264 User's Manual* on the software CD.
8. Secure the pendant tube to the end of the housing cap (GV-Mount902, No. 2) with M6 screws (GV-Mount902, No. 4).



9. Conceal the junction box with M5 screws using the torx wrench (GV-Mount203, No. 5).

10. Refer to the indicated sections of the **GV-IPCam H.264 User's Manual on the software CD** to:
  - A. Access the live view. See *Accessing the Live View, Getting Started* Chapter.
  - B. Adjust the angle, focus and zoom. See steps 6 and 7 in *Hard-Ceiling Mount, Fixed IP Dome* Chapter.
11. Put on the housing cover. See *4.1.2 Putting on the Housing Cover*.

## 4.10 Concave Corner Mount



---

### Required accessories:

- GV-Mount200
- GV-Mount310
- GV-Mount902

### The user needs to prepare:

- Screws for wall x 8
- 

1. Assemble the camera with the dome housing. See *4.1.1 Assembling the Fixed IP Dome with the Dome Housing*.
2. Assemble the mounting plates (GV-Mount310, No. 1), slide in the plain washer (GV-Mount310, No. 3), then the split washer, and secure them with the screw cap.

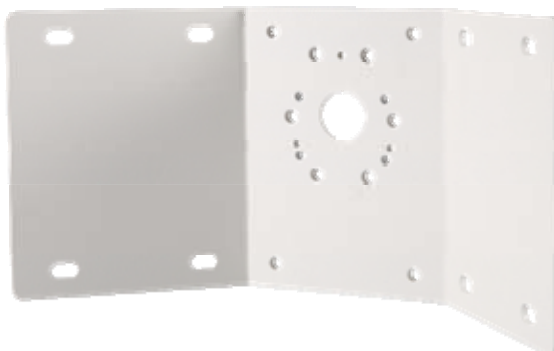

## 4 Installing the Fixed IP Dome

- Secure the pendant tube (GV-Mount200, No. 1) to the plate. Slide the 30 mm M8 screws (GV-Mount310, No. 2) from the front and secure from the back using plain washers (GV-Mount310, No. 3), split washers (GV-Mount310, No. 4) and the M8 screw caps (GV-Mount310, No. 5).

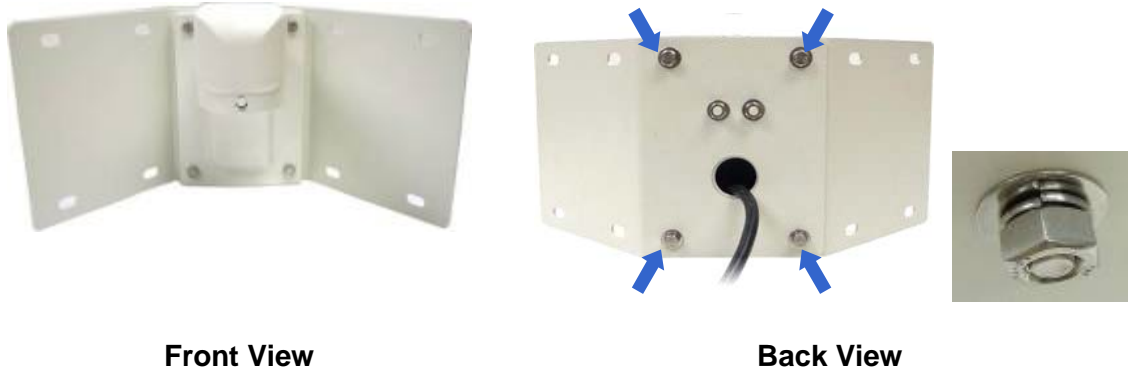

- Thread the necessary wires and cables through the pendant tube and secure the plate to the wall with 8 self-prepared screws.
- Connect the network, power and other cables to the camera. See *Connecting the Camera, Fixed IP Dome* Chapter, *GV-IPCam H.264 User's Manual* on the software CD.
- Secure the pendant tube to the end of the housing cap (GV-Mount902, No. 2) with M6 screws (GV-Mount902, No. 4).
- Refer to the indicated sections of the **GV-IPCam H.264 User's Manual on the software CD** to:
  - Access the live view. See *Accessing the Live View, Getting Started* Chapter.
  - Adjust the angle, focus and zoom. See steps 6 and 7 in *Hard-Ceiling Mount, Fixed IP Dome* Chapter.
- Put on the housing cover. See *4.1.2 Putting on the Housing Cover*.

## 4.11 Pole Mount



---

**Required accessories:**

- GV-Mount200
  - GV-Mount400 or GV-Mount410
  - GV-Mount902
- 

1. Assemble the camera with the dome housing. See *4.1.1 Assembling the Fixed IP Dome with the Dome Housing*.
2. Secure the pendant tube (GV-Mount200, No. 1) to the mounting bracket (GV-Mount400 / GV-Mount410, No. 1). Slide the 30 mm M8 screws (GV-Mount400 / GV-Mount410, No. 3) from the front and secure from the backside using plain washer (GV-Mount400 / GV-Mount410, No. 5), split washer (GV-Mount400 / GV-Mount410, No. 6) and screw cap (GV-Mount400 / GV-Mount410, No. 7).



**Backside View**



## 4 Installing the Fixed IP Dome

3. Thread the necessary wires and cables through the pendant tube and secure the mounting bracket to the pole using 3 steel straps (GV-Mount400 / GV-Mount410, No. 2). Rotate the screw on the strap to adjust its size.



4. Thread the wires and cables into the dome housing and connect the network, power and other cables to the camera. See *Connecting the Camera, Fixed IP Dome* Chapter, *GV-IPCam H.264 User's Manual* on the software CD.
5. Secure the pendant tube to the end of the housing cap (GV-Mount902, No. 2) with M6 screws (GV-Mount902, No. 4).
6. Refer to the indicated sections of the **GV-IPCam H.264 User's Manual on the software CD** to:
  - A. Access the live view. See *Accessing the Live View, Getting Started* Chapter.
  - B. Adjust the angle, focus and zoom. See steps 6 and 7 in *Hard-Ceiling Mount, Fixed IP Dome* Chapter.
7. Put on the housing cover. See *4.1.2 Putting on the Housing Cover*.

## 4.12 Pole Box Mount



---

### Required accessories:

- GV-Mount203
- GV-Mount400 or GV-Mount410
- GV-Mount902

### The user needs to prepare:

- Corrugated tube x 1 (3/4",  $\varnothing$  26.0 ~ 26.5 mm)



- 
1. Assemble the camera with the dome housing. See *4.1.1 Assembling the Fixed IP Dome with the Dome Housing*.

## 4 Installing the Fixed IP Dome

2. Assemble the mounting bracket (GV-Mount400 / GV-Mount410, No. 1) and the junction box (GV-Mount203, No. 1) from the backside using 25 mm M8 screws (GV-Mount400 / GV-Mount410, No. 4), plain washer (GV-Mount400 / GV-Mount410, No. 5) and split washers (GV-Mount400 / GV-Mount410, No. 6).



**Backside View**

3. Secure the mounting bracket to the pole using 3 steel straps (GV-Mount400 / GV-Mount410, No. 2). Rotate the screw on the strap to adjust its size. Face the conduit exit downward.



4. Assemble the corrugated tube connector (GV-Mount203, No. 4) with the self-prepared corrugated tube.

- A. Dismantle the supplied corrugated tube connector. You should have 4 parts.



- B. Slide part A and part B to the self-prepared corrugated tube.

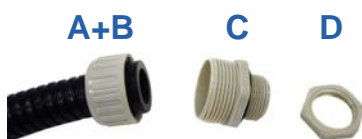

- C. Screw part C to the tube.

- D. Thread the necessary wires and cables through the corrugated tube, plug the tube to the box and secure with part D.



5. Hinge and hook the pendant tube (GV-Mount203, No. 2) to the junction box.



6. Thread the wires and cables through the pendant tube into the dome housing and connect the network, power and other cables to the camera. See *Connecting the Camera, Fixed IP Dome Chapter, GV-IPCam H.264 User's Manual* on the software CD.
7. Secure the pendant tube to the end of the housing cap (GV-Mount902, No. 2) with M6 screws (GV-Mount902, No. 4).
8. Conceal the junction box with M5 screws (GV-Mount203, No. 3) using the torx wrench (GV-Mount203, No. 5).
9. Refer to the indicated sections of the **GV-IPCam H.264 User's Manual on the software CD** to:
  - A. Access the live view. See *Accessing the Live View, Getting Started Chapter*.
  - B. Adjust the angle, focus and zoom. See steps 6 and 7 in *Hard-Ceiling Mount, Fixed IP Dome Chapter*.
10. Put on the housing cover. See *4.1.2 Putting on the Housing Cover*.

## 4.13 Power Box Mount



### Required accessories:

- GV-Mount913

### The user needs to prepare

- Screws for securing the mounting plate to power box

1. Secure the mounting plate (GV-Mount913, No. 1) to the power box with your own screws. Depending on the type of power box, use the holes indicated with the corresponding letter:

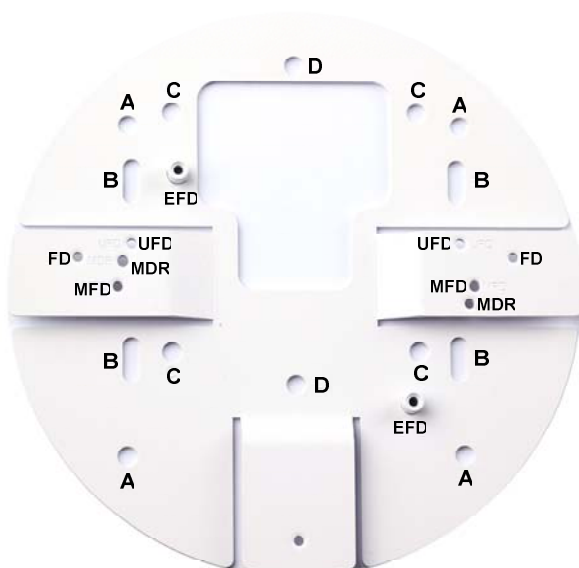

Type of Power Box	Hole
4" Square	A
Double Gang	B
4" Octagon	C
Single Gang	D

2. Unpack the camera.



3. Secure the camera to the mounting plate with M3 screws (GV-Mount913, No. 2). Use the holes indicated with “FD” to help you align the camera.

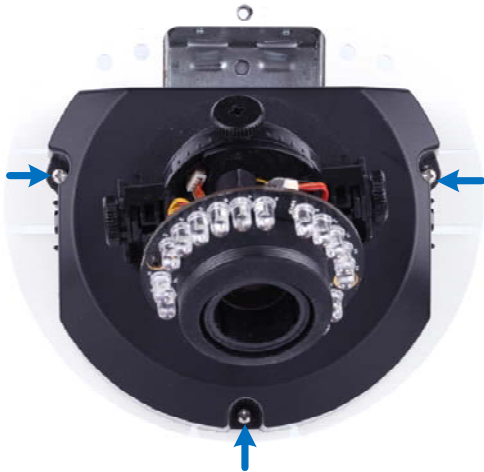

4. Refer to the indicated sections of the **GV-IPCam H.264 User's Manual on the software CD** to:
  - A. Connect the cables and wires. See *Connecting the Camera, Fixed IP Dome* Chapter.
  - B. Access the live view. See *Accessing the Live View, Getting Started* Chapter.
  - C. Adjust the angle, focus and zoom. See steps 6 and 7 in *Hard-Ceiling Mount, Fixed IP Dome* Chapter.
5. Follow step 2 to put on the camera cover.

## 5. Installing the Fisheye Camera

### 5.1 Assembling the Fisheye Camera with the Dome Housing



---

#### Required accessories:

- GV-Mount903
- 

1. Align the embossed arrow of the housing cap (GV-Mount903, No. 2) with the arrow inside the dome housing (GV-Mount903, No. 1) and secure them with three M6 screws (GV-Mount903, No. 4).



---

**Tip:** The flat hole on the housing cap should be fitted with the hole on the housing cover without any indent.

---

2. Thread the camera cable through the dome housing (GV-Mount903, No. 1).
3. Place the camera body to the dome housing. Make sure the camera cable is at the top of the dome housing arrow. Secure with three M4 screws (GV-Mount903, No. 3).

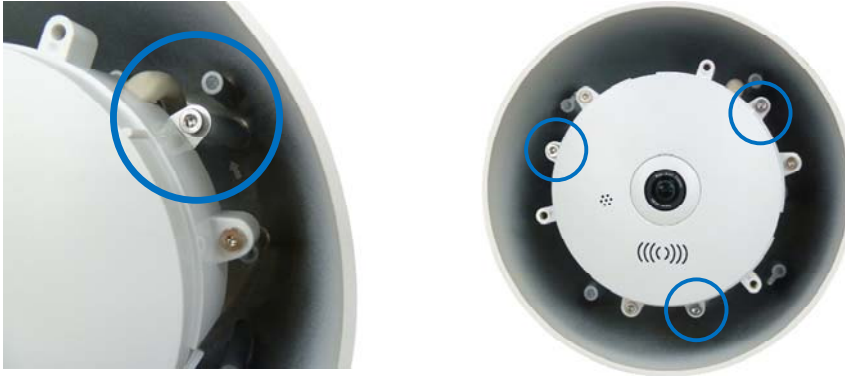

4. Place the camera cover for in-ceiling mount on the camera body and secure the 3 screws with the supplied torx wrench.





## 5.2 Straight Tube Box Mount



---

### Required accessories:

- GV-Mount100
- GV-Mount903

### The user needs to prepare:

- Screws for ceiling x 4
- Corrugated tube x 1 (3/4",  $\varnothing$  26.0 ~ 26.5 mm)



### Optionally extend with:

- GV-Mount702
-

1. Assemble the camera to the dome housing. See *5.1 Assembling the Fisheye Camera with the Dome Housing*.
2. Assemble the tube (GV-Mount100, No. 3) and the tube connector (GV-Mount100, No. 4).



3. Thread the camera cable through the tube and secure the tube to the end of the housing cap (GV-Mount903, No.2) with M6 screws (GV-Mount903, No. 4).



4. Thread the camera cable through the box cover (GV-Mount100, No. 2), assemble the box cover and the tube, and tighten the torxes with the supplied torx wrench (GV-Mount100, No. 7).



## 5 Installing the Fisheye Camera

5. Secure the junction box (GV-Mount100, No. 1) to the ceiling with 4 self-prepared screws.



6. Assemble the corrugated tube connector (GV-Mount100, No. 6) with the self-prepared corrugated tube.

- A. Dismantle the supplied corrugated tube connector. You should have 4 components.



- B. Slide part A and part B to the self-prepared corrugated tube.

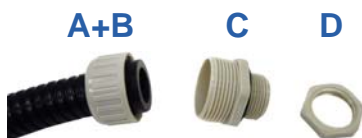

- C. Screw part C to the tube.

- D. Thread the necessary wires and cables from the ceiling through the corrugated tube, plug the tube to the box and secure with part D.

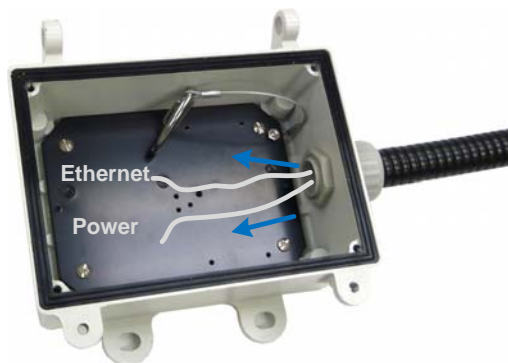

7. Connect the network, power and other cables to the camera. See *1.7 Connecting the Data Cable, GV-Fisheye IP Camera H.264 User's Manual* on the software CD.

8. Hinge and hook the box cover and secure it with M5 flat screws (GV-Mount100, No. 5).

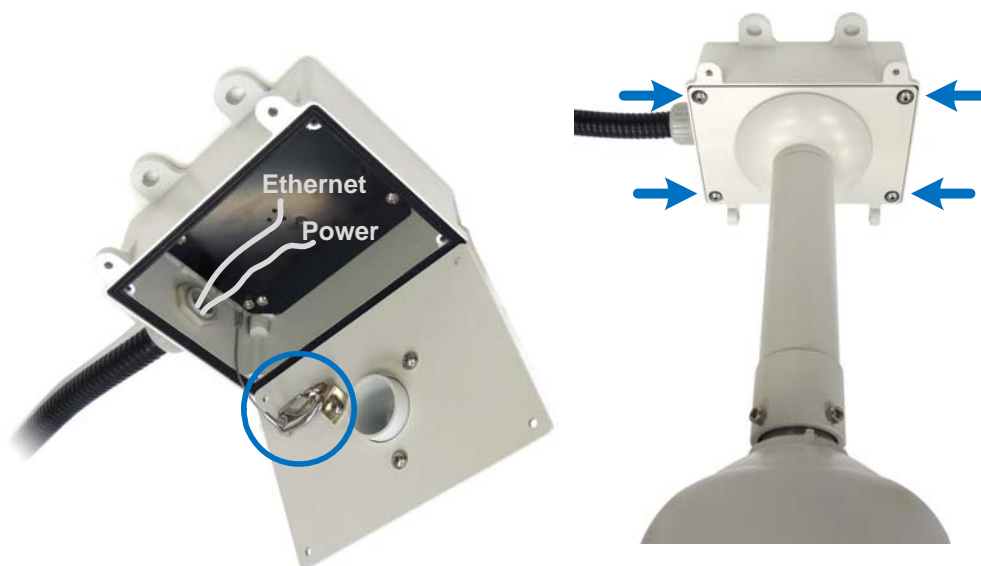

9. Access the live view. See 2.1 *Installing on a Network*, *GV-Fisheye IP Camera H.264 User's Manual* on the software CD.

## 5.3 Straight Tube Mount



---

**Required accessories:**

- GV-Mount101
- GV-Mount903

**The user needs to prepare:**

- Screws for ceiling x 4

**Optionally extend with:**

- GV-Mount702
-

1. Assemble the camera with the dome housing. See *5.1 Assembling the Fisheye Camera with the Dome Housing*.
2. Assemble the tube (GV-Mount101, No. 2) and the tube connector (GV-Mount101, No. 3).



3. Thread the camera cable through the tube and secure the tube to the end of the housing cap (GV-Mount903, No.2) with M6 screws (GV-Mount903, No. 4).



4. Thread the camera cable through the mounting bracket (GV-Mount101, No. 1) and assemble the tube with the mounting bracket.
5. Make sure the tubes are properly screwed and tighten the torxes using the supplied torx wrench (GV-Mount101, No. 4).



6. Secure the assembled camera to a desired location with 4 self-prepared screws.
7. Refer to the indicated sections of the *GV-Fisheye IP Camera H.264 User's Manual* on the software CD to:
  - A. Connect the network, power and other cables to the camera. See *1.7 Connecting the Data Cable*.
  - B. Access live view. See *2.1 Installing on a Network*.

## 5.4 Wall Mount



---

**Required accessories:**

- GV-Mount205
- 

---

**IMPORTANT:** GV-FE2303 / 3403 / 4303 / 5303 with the POE converter are not supported.

---

1. Take the wall mount bracket (GV-Mount205, No. 1) and make 4 marks on the wall for screw anchors.



2. Drill the marks and insert screw anchors (GV-Mount205, No. 6).

3. Align and secure the mounting plate (GV-Mount205, No. 2) to the wall mount bracket with 4 M4 screws (GV-Mount205, No. 4).

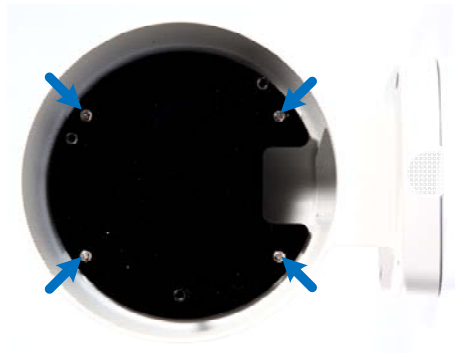

4. Align and secure the housing plate (GV-Mount205, No. 3) to the mounting plate with 3 M4 screws (GV-Mount205, No. 4).

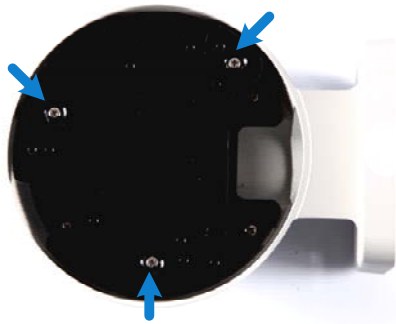

5. Thread the camera cable through the wall mount bracket as below.

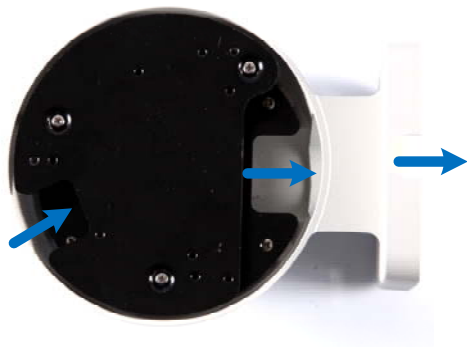



## 5 Installing the Fisheye Camera

- Align and secure the camera to the housing plate with 3 M4 screws (GV-Mount205, No. 4).

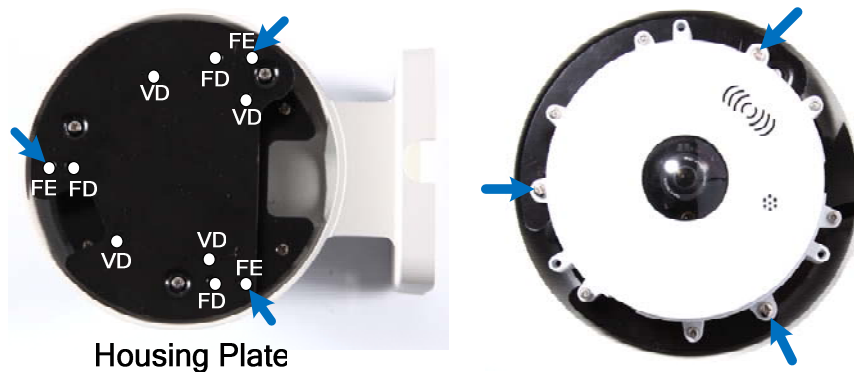

- Place the camera cover for hard ceiling mount on top of the camera and tighten the screws using the supplied torx wrench.



- Secure the wall mount bracket to the wall with 40 mm M4 screws (GV-Mount205, No. 5) and plain washers (GV-Mount205, No. 7).
- Refer to the indicated sections of the *GV-Fisheye IP Camera H.264 User's Manual* on the software CD to:
  - Connect the network, power and other cables to the camera. See *1.7 Connecting the Data Cable*.
  - Access the live view. See *2.1 Installing on a Network*.

## 5.5 Wall Pendant Mount



---

### Required accessories:

- GV-Mount200
- GV-Mount903

### The user needs to prepare:

- Screws for wall x 4
- 

1. Assemble the Fisheye camera with the dome housing. See *5.1 Assembling the Fisheye Camera with the Dome Housing*.
2. Insert the housing cap (GV-Mount903, No. 2) into the wall pendant tube (GV-Mount200, No. 1) and secure the tube to the end of the housing cap (GV-Mount903, No.2) with M6 screws (GV-Mount903, No. 4).



3. Place the wall pendant tube on the wall and secure with four screws of your choice.

## 5.6 Tilting Wall Mount



Front View



Side View: Flat



Side View: Tilted

---

**Required accessories:**

- GV-Mount904
- 

1. Unscrew the inner housing cover using the supplied torx wrench.



2. Assemble the tilting rack (GV-Mount904, No. 3) with the back plate (GV-Mount904, No. 2) and secure them together with 3 short screws (GV-Mount904, No. 5) from the back.



Front View



Back View

3. Thread the camera cable into an opening on the back plate and align the top side of the camera with the top of the back plate.

---

**Tip:** Pull the tilting rack to a wider angle for easier threading.

---



4. Secure the camera from the back with 3 long screws (GV-Mount904, No. 4).

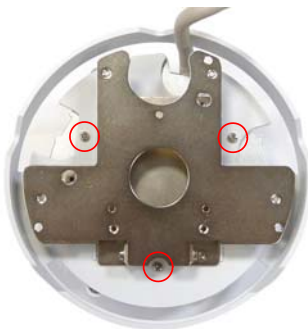

5. Put on the back cover and secure it with 6 short screws (GV-Mount904, No. 5).



## 5 Installing the Fisheye Camera

6. To accommodate the adjustment, reserve some length of cable by making a curve in-between the back plate and the back cover.



7. Paste the supplied sticker (GV-Mount904, No. 6) on the wall. The 3 red dots indicate the screw position.

---

**Important:** Be sure that the “TOP” arrow on the sticker points toward the ceiling.

---

8. Drill the 3 red dots and insert the supplied plastic screw anchor.
9. Secure the camera to wall using 3 supplied screws.



10. Insert a micro SD card to the camera.
11. Secure the inner housing cover using the supplied torx wrench.
12. Secure the supplied camera cover (hard-ceiling mount) using the supplied torx wrench.



## 5.7 Convex Corner Mount



---

### Required accessories:

- GV-Mount200
- GV-Mount300
- GV-Mount903

### The user needs to prepare:

- Screws for wall x 8

- 
1. Assemble the camera with the dome housing. See *5.1 Assembling the Fisheye Camera with the Dome Housing*.
  2. Thread the camera cable through the wall pendant tube (GV-Mount200, No. 1), and secure the tube to the end of the housing cap (GV-Mount903, No.2) with M6 screws (GV-Mount903, No. 4).



## 5 Installing the Fisheye Camera

3. Assemble the mounting plates (GV-Mount300, No. 1), slide in the plain washer (GV-Mount300, No. 4), then the split washer (GV-Mount300, No. 5), and secure with the screw cap (GV-Mount300, No. 6).



4. Thread the camera cable and secure the pendant tube to the plates. Slide the 30 mm M8 screws (GV-Mount300, No. 2) from the front and secure from the backside using plain washer (GV-Mount300, No. 4), split washer (GV-Mount300, No. 5) and screw cap (GV-Mount300, No. 6).



**Backside View**

5. Secure the plates to the wall with 8 self-prepared screws.
6. Refer to the indicated sections of the *GV-Fisheye IP Camera H.264 User's Manual* on the software CD to:
  - A. Connect the network, power and other cables to the camera. See *1.7 Connecting the Data Cable*.
  - B. Access live view. See *2.1 Installing on a Network*.

## 5.8 Convex Corner Box Mount



---

### Required accessories:

- GV-Mount203
- GV-Mount300
- GV-Mount903

### The user needs to prepare:

- Screws for wall x 8
- Corrugated tube x 1 (3/4",  $\varnothing$  26.0 ~ 26.5 mm)



- 
1. Assemble the camera with the dome housing. See *5.1 Assembling the Fisheye Camera with the Dome Housing*.
  2. Assemble the mounting plates (GV-Mount300, No. 1), slide in the plain washer (GV-Mount300, No. 4), then the split washer (GV-Mount300, No. 5), and secure them with the screw cap (GV-Mount300, No. 6).

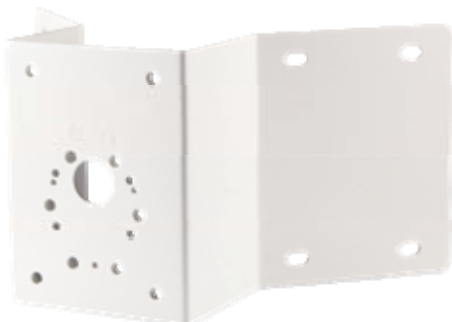



## 5 Installing the Fisheye Camera

- Secure the junction box (GV-Mount203, No. 1) to the mounting plates from the backside using the 25 mm M8 screw (GV-Mount300, No. 3), plain washer (GV-Mount300, No. 4), and split washer (GV-Mount300, No. 5).

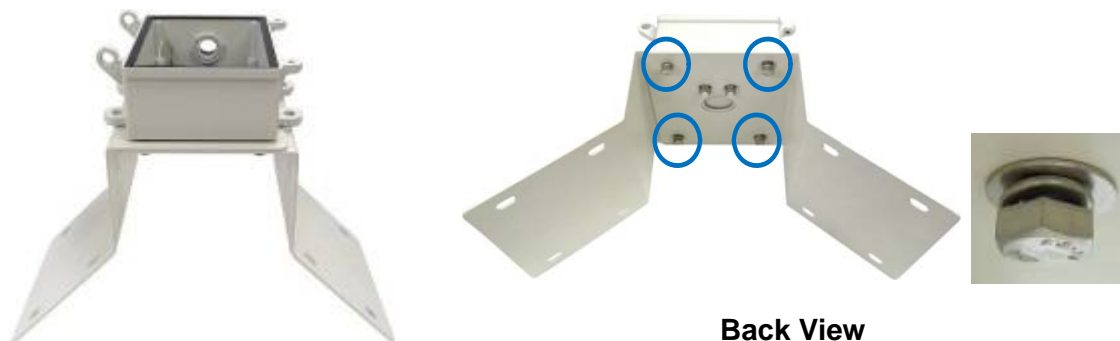

- Secure the mounting plates to the wall with 8 self-prepared screws. Face the conduit exit downward.
- Assemble the corrugated tube connector (GV-Mount203, No. 4) with the self-prepared corrugated tube.
  - Dismantle the supplied corrugated tube connector. You should have 4 parts.



- Slide part A and part B to the self-prepared corrugated tube.



- Screw part C to the tube.
- Thread the necessary wires and cables from the wall or the ceiling through the corrugated tube, plug the tube to the box and secure with part D.

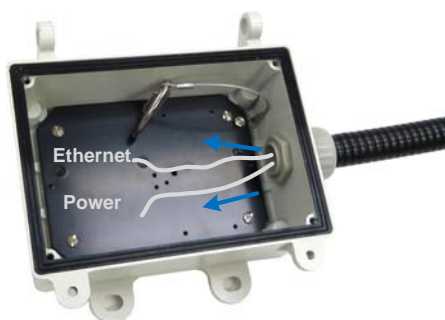

6. Thread the camera cable through the wall pendant tube (GV-Mount203, No. 2), and secure the tube to the end of the housing cap (GV-Mount903, No. 2) with M6 screws (GV-Mount903, No. 4).

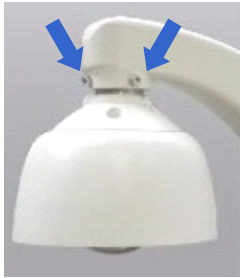

7. Hinge and hook the pendant tube to the junction box.



8. Connect the network, power and other cables to the camera. See *1.7 Connecting the Data Cable, GV-Fisheye IP Camera H.264 User's Manual* on the software CD.
9. Conceal the box with M5 screws (GV-Mount203, No. 3) using the torx wrench (GV-Mount203, No. 5).
10. Access the live view. See *2.1 Installing on a Network, GV-Fisheye IP Camera H.264 User's Manual* on the software CD.

## 5.9 Concave Corner Mount

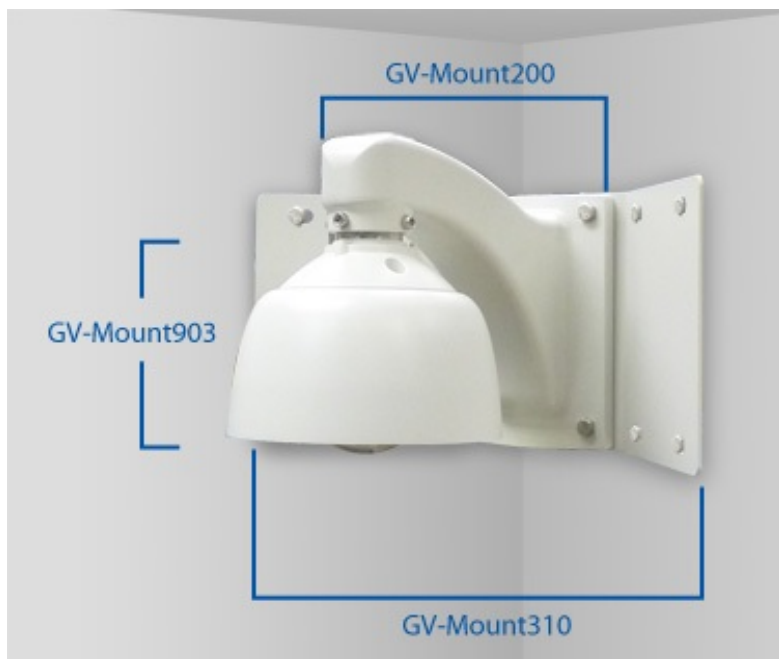

---

### Required accessories:

- GV-Mount200
- GV-Mount310
- GV-Mount903

### The user needs to prepare:

- Screws for wall x 8
- 

1. Assemble the camera with the dome housing. See *5.1 Assembling the Fisheye Camera with the Dome Housing*.
2. Assemble the mounting plates (GV-Mount310, No. 1), slide in the plain washer (GV-Mount310, No. 3), then the split washer (GV-Mount310, No. 4), and secure them with the screw cap (GV-Mount310, No. 5).

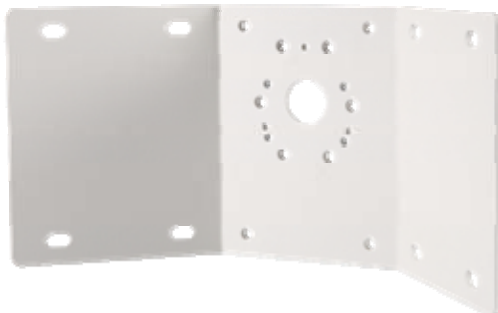

3. Thread the camera cable through the wall pendant tube (GV-Mount200, No. 1), and secure the tube to the end of the housing cap (GV-Mount903, No. 2) with M6 screws (GV-Mount903, No. 4).



4. Thread the camera cable and secure the pendant tube to the plates. Slide the 30 mm M8 screws (GV-Mount903, No. 2) from the front and secure from the backside using plain washer (GV-Mount903, No. 3), split washer (GV-Mount903, No. 4) and secure with M8 screw cap (GV-Mount903, No. 5).



**Front View**

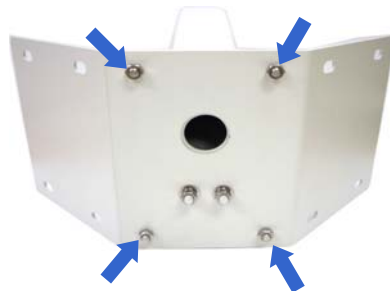

**Back View**



5. Secure the plates to the wall with 8 self-prepared screws.
6. Refer to the indicated sections of the ***GV-Fisheye IP Camera H.264 User's Manual*** on the software CD to:
  - A. Connect the network, power and other cables to the camera. See *1.7 Connecting the Data Cable*.
  - B. Access live view. See *2.1 Installing on a Network*.

## 5.10 Pole Mount



---

### Required accessories:

- GV-Mount200
  - GV-Mount400 or GV-Mount410
  - GV-Mount903
- 

1. Assemble the camera with the dome housing. See *5.1 Assembling the Fisheye Camera with the Dome Housing*.
2. Secure the mounting bracket (GV-Mount400 / GV-Mount410, No. 1) to the pole using 3 steel straps (GV-Mount400 / GV-Mount410, No. 2). Rotate the screw on the strap to adjust its size.



3. Thread the camera cable through the pendant tube (GV-Mount200, No. 1) and secure the the tube to the end of the housing cap (GV-Mount903, No. 2) with M6 screws (GV-Mount903, No. 4).



4. Thread the camera cable through the mounting bracket and secure the pendant tube to the bracket. Slide the 30 mm M8 screws (GV-Mount400 / GV-Mount410, No. 3) from the front and secure from the backside using plain washer (GV-Mount400 / GV-Mount410, No. 5), split washer (GV-Mount400 / GV-Mount410, No. 6) and screw cap (GV-Mount400 / GV-Mount410, No. 7).



**Backside View**

5. Refer to the indicated sections of the ***GV-Fisheye IP Camera H.264 User's Manual*** on the software CD to:
  - A. Connect the network, power and other cables to the camera. See *1.7 Connecting the Data Cable*.
  - B. Access live view. See *2.1 Installing on a Network*.

## 5.11 Pole Box Mount



---

### Required accessories:

- GV-Mount203
- GV-Mount400 or GV-Mount410
- GV-Mount903

### Required accessories:

- Corrugated tube x 1 (3/4",  $\varnothing$  26.0 ~ 26.5 mm)



1. Assemble the camera with the dome housing. See *5.1 Assembling the Fisheye Camera with the Dome Housing*.
2. Secure the junction box (GV-Mount203, No. 1) to the mounting bracket (GV-Mount400 / GV-Mount410, No. 1) from the backside using 25 mm M8 screws (GV-Mount400 / GV-Mount410, No. 4), plain washer (GV-Mount400 / GV-Mount410, No. 5) and split washers (GV-Mount400 / GV-Mount410, No. 6).



**Backside View**

3. Secure the mounting bracket to the pole using 3 steel straps (GV-Mount400 / GV-Mount410, No. 2). Rotate the screw on the strap to adjust its size. Face the conduit exit downward.

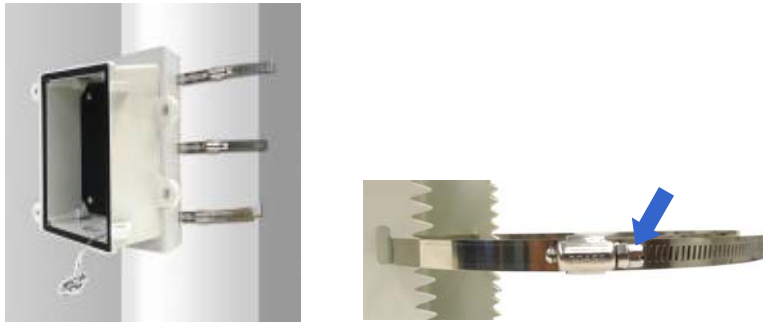

4. Assemble the corrugated tube connector (GV-Mount203, No. 4) with the self-prepared corrugated tube.

- A. Dismantle the supplied corrugated tube connector. You should have 4 parts.



- B. Slide part A and part B to the self-prepared corrugated tube.



- C. Screw part C to the tube.
- D. Thread the necessary wires and cables through the corrugated tube, plug the tube to the box and secure with part D.

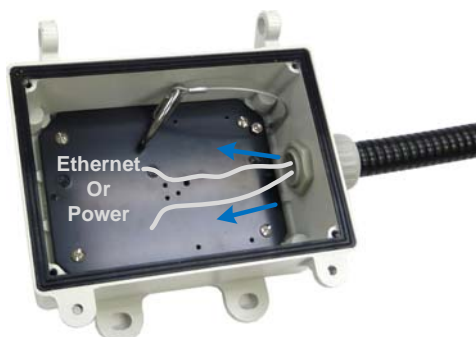



## 5 Installing the Fisheye Camera

5. Thread the camera cable through the pendant tube (GV-Mount203, No. 2) and secure the tube to the end of the housing cap (GV-Mount903, No. 2) with M6 screws (GV-Mount903, No. 4).

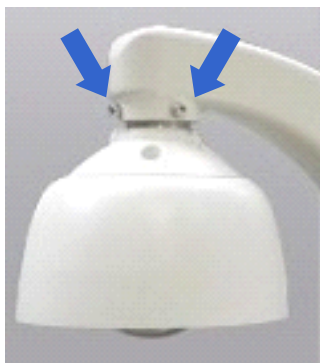

6. Hinge and hook the pendant tube to the junction box.



7. Connect the network, power and other cables to the camera. See *1.7 Connecting the Data Cable, GV-Fisheye IP Camera H.264 User's Manual* on the software CD.
8. Conceal the junction box with M5 screws (GV-Mount203, No. 3) using the torx wrench (GV-Mount203, No. 5).
9. Access the live view. See *2.1 Installing on a Network, GV-Fisheye IP Camera H.264 User's Manual* on the software CD.

## 5.12 Power Box Mount



### Required accessories:

- GV-Mount912

### The user needs to prepare

- Screws for securing the mounting plate to power box

1. Secure the mounting plate (GV-Mount912, No. 1) to the power box with your own screws. Depending on the type of power box, use the holes indicated with the corresponding letter:

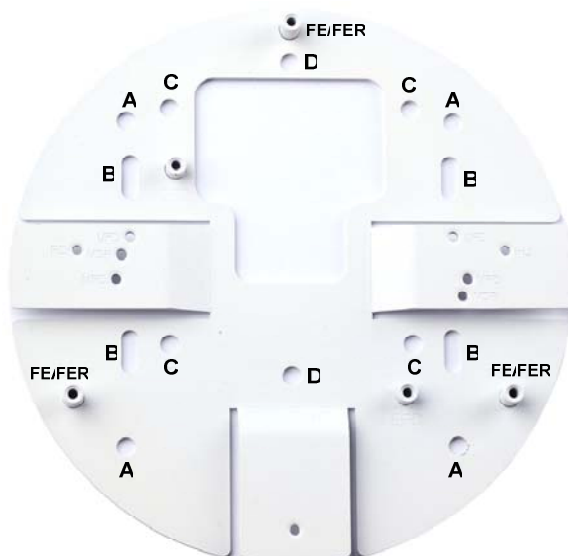

Type of Power Box	Hole
4" Square	A
Double Gang	B
4" Octagon	C
Single Gang	D

## 5 Installing the Fisheye Camera

2. Thread the camera cable through the mounting plate and the power box, and secure the camera to the mounting plate with M3 screws (GV-Mount912, No. 2). Use the holes indicated with “FE/FER”.



3. Refer to the indicated sections of the **GV-Fisheye Camera User's Manual on the software CD** to:
  - A. Connect the cables and wires. See *1.7 Connecting the Data Cable*.
  - B. Access the live view. See *2.1 Installing on a Network*.

## 6. Installing the GV-SD220/220-S IP Speed Dome

### 6.1 Assembling GV-SD220-S with Pendant Tube



---

#### Required Item

- GV-SD220 standard package
- 

1. Insert the desiccants to the camera.
  - A. Remove the camera cover using the supplied hex key.



## 6 Installing the GV-SD220/220-S

- B. Insert two desiccant packs to indicated positions.



---

**IMPORTANT:** Be sure the desiccant is concealed in the GV-IP Speed Dome within 2 minutes of opening the desiccant pack.

---

- C. Follow step 1 to secure the camera cover with the supplied hex key.
2. Assemble the camera with the pendant tube.
- A. Thread the camera cable through the pendant tube.
- B. Rotate the camera and lock it to the pendant tube.



- C. Secure the camera to the pendant tube with the supplied M6 screws.



## 6.2 GV-SD220 In-Ceiling Mount



---

This installation method is only applicable to **indoor GV-IP Speed Dome (GV-SD220)**.

### Required Items

- GV-Mount907

### The user needs to prepare:

- ceiling screws x 3

- 
1. Assemble the support racks, mounting plate and the mounting ring.
    - A. Secure the three support racks (GV-Mount907, No. 1) to the mounting ring (GV-Mount907, No.2) from the underside with screws (GV-Mount907, No. 3).



- B. Secure the thread lock (GV-Mount907, No. 4) to the mounting plate (GV-Mount907, No. 5) using the screw (GV-Mount907, No. 4).



## 6 Installing the GV-SD220/220-S

- C. Secure the mounting plate with the support racks with screws (GV-Mount907, No. 3). Make sure the arrows on the mounting ring and mounting plate are aligned.

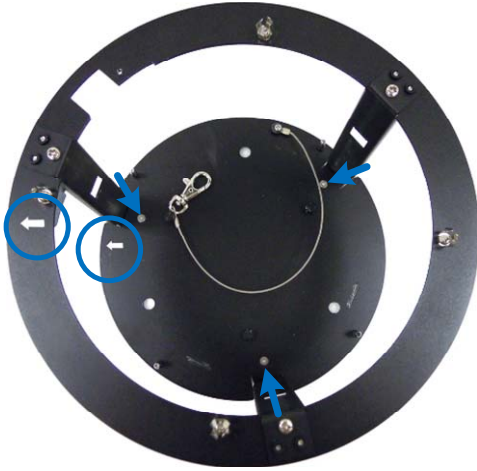

2. Secure the lock plate to the GV-IP Speed Dome.

- A. Unscrew the screw on the side of the camera body with the supplied hex key (GV-Mount907, No. 6).



- B. Secure the lock plate (GV-Mount907, No. 7) to the camera body with the supplied screw (GV-Mount907, No. 7).



3. Assemble the GV-IP Speed Dome to the assembly done in step 1.

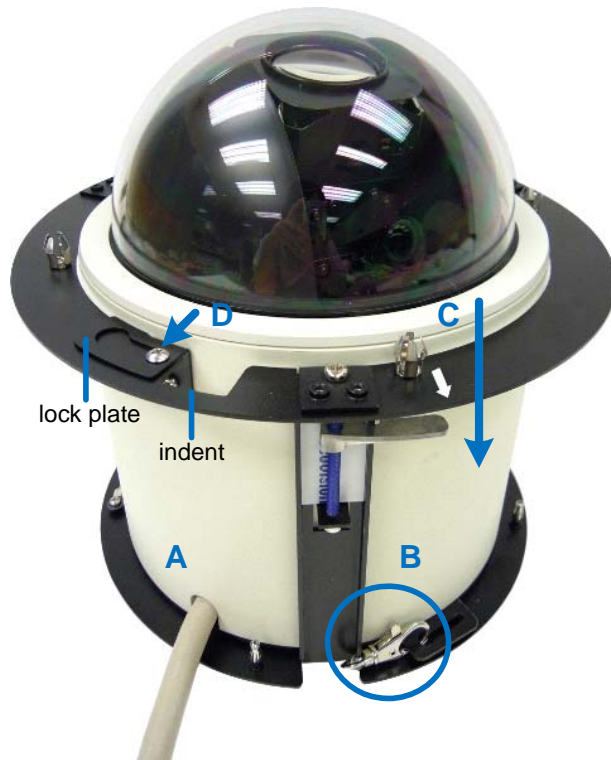

- A. Thread the camera cable under the indent of the mounting ring.
  - B. Hook the camera from the underside.
  - C. Align the lock plate on the camera to the indent of the mounting ring. The camera should lie completely on the mounting plate.
  - D. Rotate the camera to lock and secure the lock plate with the supplied screw.
4. Paste the installation sticker (GV-Mount907, No. 8) to the ceiling and drill the ceiling to the size of the installation sticker.
  5. Insert the camera to the ceiling. Adjust the clips and screws to clip the camera tightly to the ceiling.



6. Put on the in-ceiling cover (GV-Mount907, No. 9) to finish installation.



## 6 Installing the GV-SD220/220-S

7. Connect the network, power and other cables to the camera. See *1.6 Connecting the Camera, GV-IP Speed Dome GV-SD220 User's Manual* on the software CD.

## 6.3 GV-SD220-S In-Ceiling Mount



---

This installation method is only applicable to **outdoor GV-IP Speed Dome (GV-SD220-S)**. **The complete installation weights 6.75 Kg / 14.88 lb. Make sure the chosen ceiling can bear the weight.**

### Required Items

- GV-Mount908

- 
1. Assemble the housing cap (GV-Mount908, No. 1) with the mounting plate (GV-Mount908, No. 2) with 4 screws (GV-Mount908, No. 3).

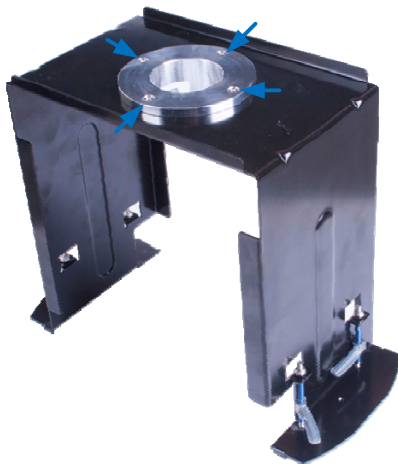

---

**IMPORTANT:** The housing cap only fits the mounting plate in a certain position. Rotate the housing cap on the mounting plate to make sure it fits tightly before securing it to the mounting plate.

---

2. Remove the camera dome.



3. Secure the camera with the assembled mounting plate.
  - A. Put 2 screws (GV-Mount908, No. 4) loosely on the opposite sides of the camera.
  - B. Thread the camera cable through the mounting plate and the housing cap.
  - C. Rotate the camera so that the screws lodge in the housing cap at the indicated position.

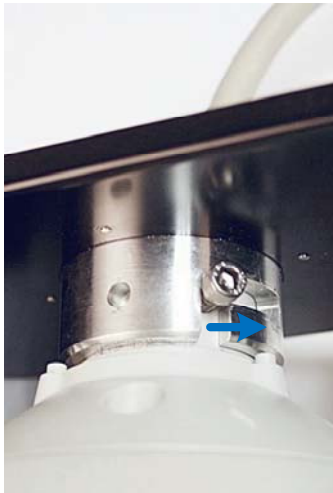

- D. Put on another 2 screws (GV-Mount908, No. 4) and use the hex key (GV-Mount908, No.5) to secure all 4 screws tightly.



4. Drill the ceiling. Use the installation sticker (GV-Mount908, No. 6) to help you estimate the size of the camera.
5. Thread the camera cable through the ceiling and insert the camera. Adjust the 4 screws to clip the camera tightly to the ceiling.

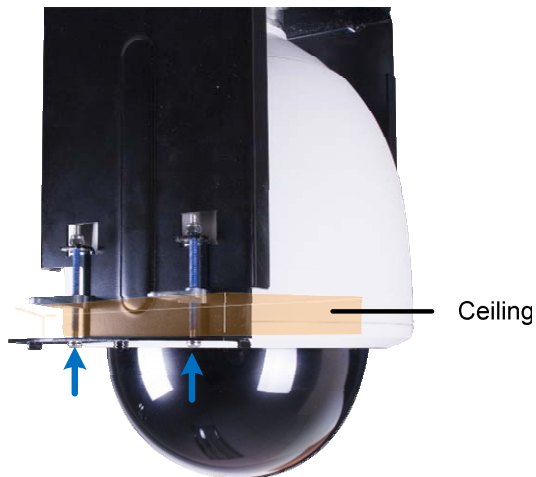

6. Secure the in-ceiling cover (GV-Mount908, No. 7) with 2 screws (GV-Mount908, No. 8) using the hex key (standard package).



7. Connect the network, power and other cables to the camera. See *1.6 Connecting the Camera, GV-IP Speed Dome GV-SD220 User's Manual* on the software CD.

## 6.4 Straight Tube Box Mount

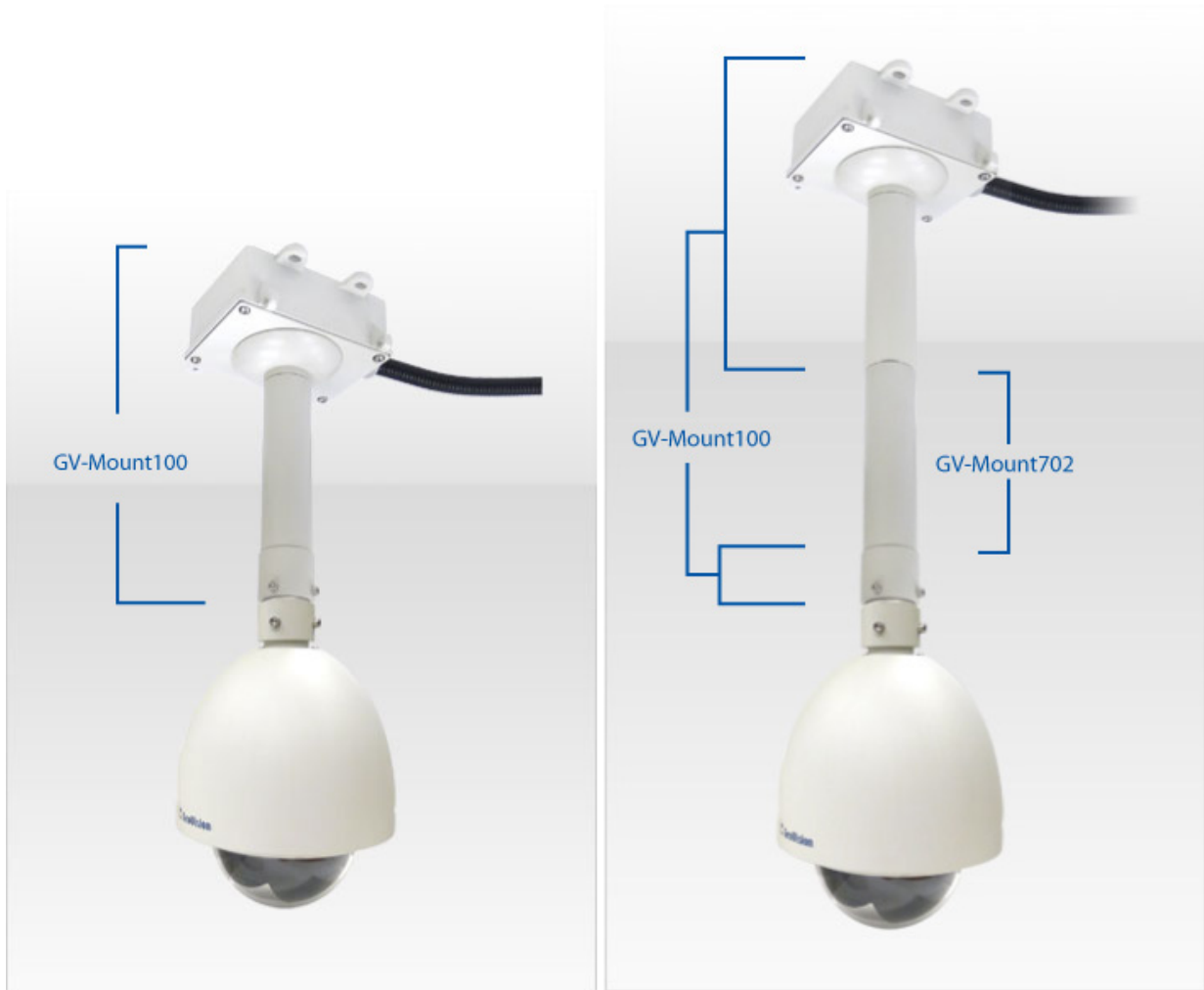

This installation method is only applicable to **outdoor GV-IP Speed Dome (GV-SD220-S)**.

**Required accessories:**

- GV-Mount100

**The user needs to prepare:**

- Screws for ceiling x 4
- Corrugated tube x 1 (3/4",  $\varnothing$  26.0 ~ 26.5 mm)



**Optionally extend with:**

- GV-Mount702

1. Follow step 1 in *6.1 Assembling GV-SD220-S with Pendant Tube* to insert the desiccant packs.
2. Remove the tube connector from the pendant tube with the supplied hex key. Save the M6 screws for later use.

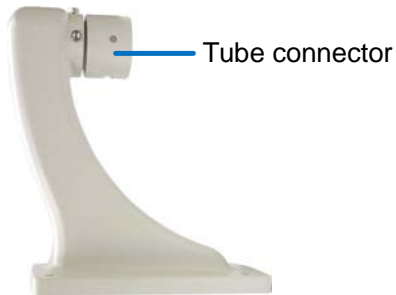

3. Secure the tube connector to the dome.
  - A. Assemble the tube connector with the dome and rotate the tube connector to lock it with the dome.

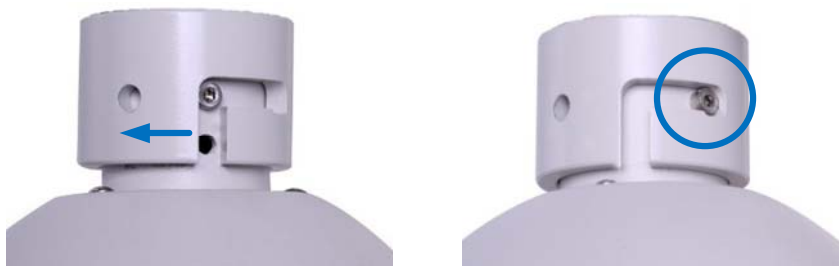

- B. Secure the tube connector with the supplied M6 screws.



4. Assemble the tube (GV-Mount100, No. 3) and the tube connector (GV-Mount100, No. 4).



## 6 Installing the GV-SD220/220-S

5. Thread the camera cable through the tube and secure the tube to the dome with M6 screws.
6. Follow steps 3 to 6 in *5.2 Straight Tube Box Mount* to secure the tube and the junction box.
7. Connect the network, power and other cables to the camera. See *1.6 Connecting the Camera, GV-IP Speed Dome GV-SD220 User's Manual* on the software CD.
8. Hinge and hook the box cover and secure it with M5 flat screws (GV-Mount100, No. 5).

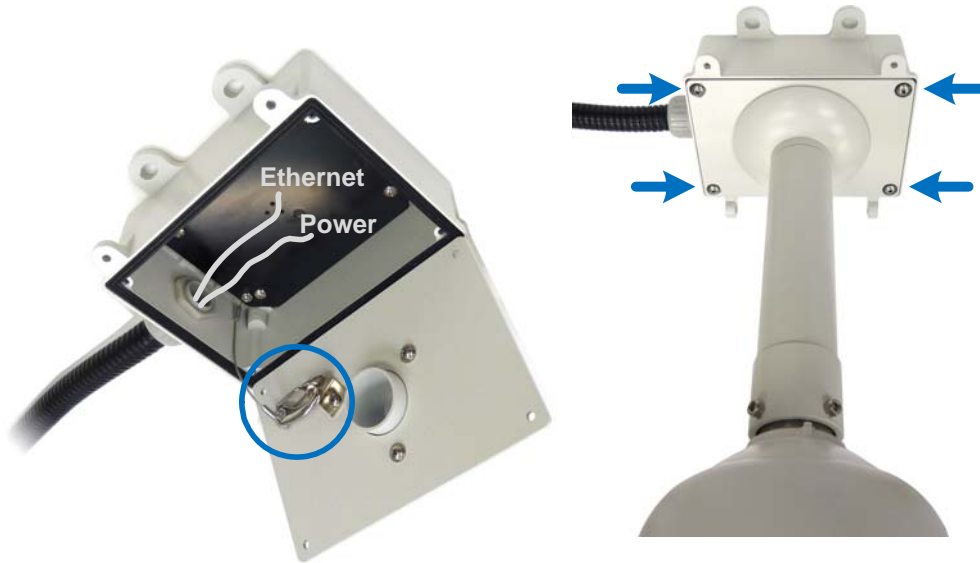

## 6.5 Straight Tube Mount

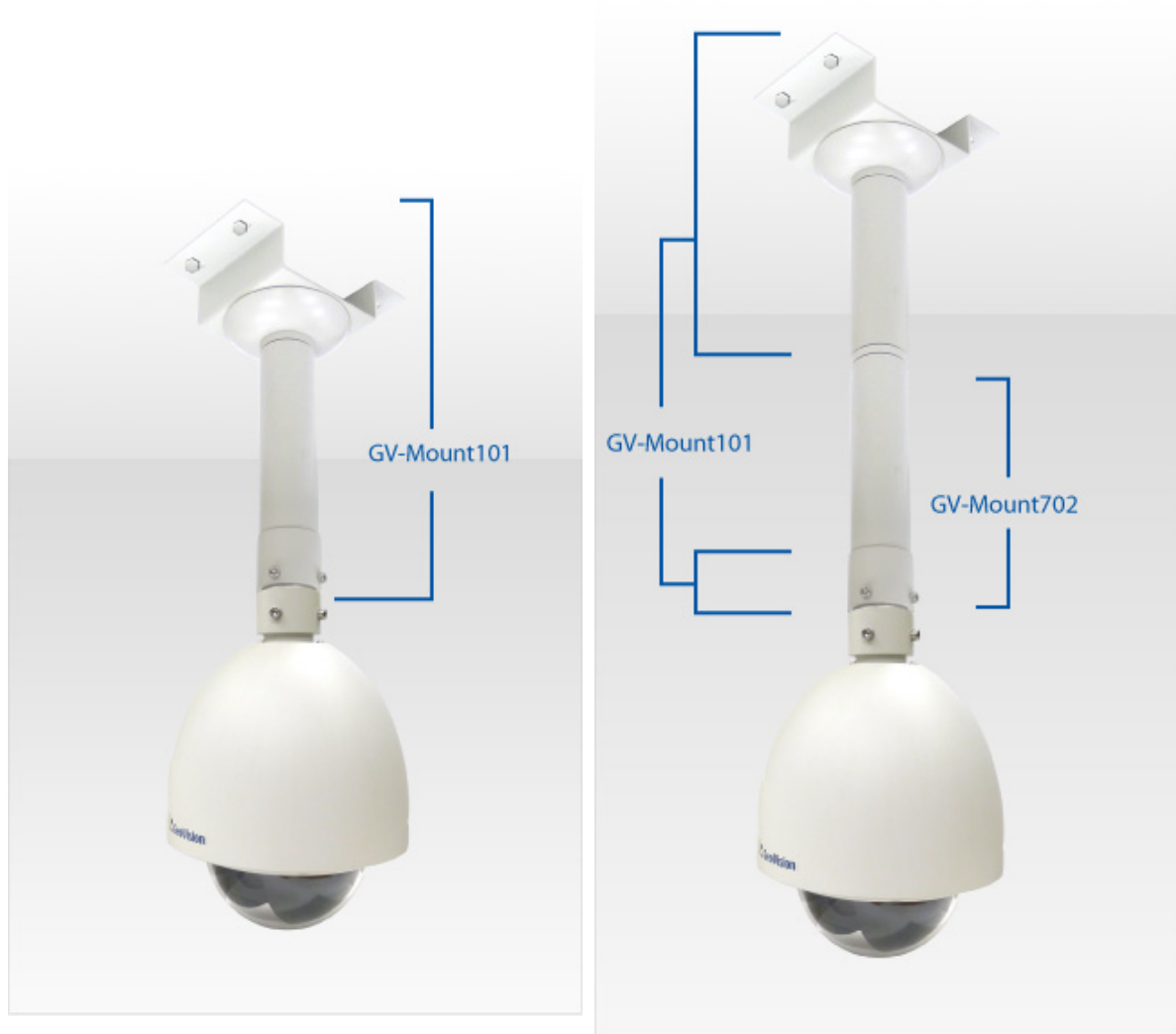

---

This installation method is only applicable to **outdoor GV-IP Speed Dome (GV-SD220-S)**.

**Required accessories:**

- GV-Mount101

**The user needs to prepare:**

- Screws for ceiling x 4

**Optionally extend with:**

- GV-Mount702
-



## 6 Installing the GV-SD220/220-S

1. Follow steps 1 to 3 in *6.1 Assembling GV-SD220-S with Pendant Tube* to insert the desiccant.
2. Remove the tube connector from the pendant tube with the supplied hex key.

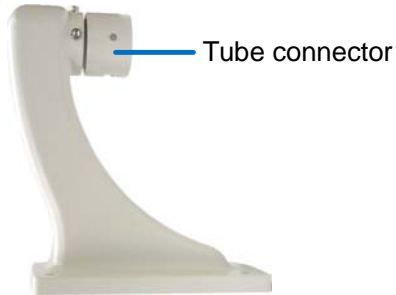

3. Secure the tube connector to the dome.
  - A. Assemble the tube connector with the dome and rotate the tube connector to lock it with the dome.

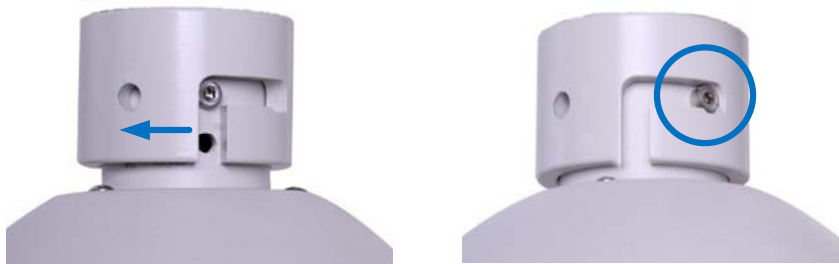

- B. Secure the tube connector with the supplied M6 screws.



4. Assemble the tube (GV-Mount101, No. 2) and the tube connector (GV-Mount101, No. 3).



5. Thread the camera cable through the tube and secure the tube to the dome with M6 screws.

6. Follow steps 4 to 6 in *5.3 Straight Tube Mount* to assemble the mounting bracket and secure the dome to the ceiling.
7. Connect the network, power and other cables to the camera. See *1.6 Connecting the Camera, GV-IP Speed Dome GV-SD220 User's Manual* on the software CD.

## 6.6 Convex Corner Mount



---

This installation method is only applicable to **outdoor GV-IP Speed Dome (GV-SD220-S)**.

**Required accessories:**

- Pendant Tube (in GV-SD220-S standard package)
- GV-Mount300

**The user needs to prepare:**

- Screws for wall x 8

- 
1. Assemble the camera with the pendant tube. See *6.1 Assembling GV-SD220-S with Pendant Tube*.
  2. Follow steps 3 to 5 in *5.6 Convex Corner Mount* to assemble the mounting plates to the camera and secure the camera to the wall.
  3. Connect the network, power and other cables to the camera. See *1.6 Connecting the Camera, GV-IP Speed Dome GV-SD220 User's Manual* on the software CD.

## 6.7 Convex Corner Box Mount



---

This installation method is only applicable to **outdoor GV-IP Speed Dome (GV-SD220-S)**.

### Required accessories:

- GV-Mount203
- GV-Mount300

### The user needs to prepare:

- Screws for wall x 8
- Corrugated tube x 1 (3/4",  $\varnothing$  26.0 ~ 26.5 mm)



- 
1. Follow steps 2 to 5 in *5.7 Convex Corner Box Mount* to assemble the mounting plates, box and corrugated tube and secure them to the wall.
  2. Follow step 1 in *6.1 Assembling GV-SD220-S with Pendant Tube* to insert the desiccant packs.

## 6 Installing the GV-SD220/220-S

3. Remove the tube connector from the pendant tube with the supplied hex key. Save the M6 screws for later use.

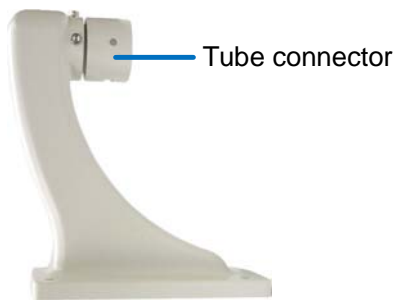

4. Secure the tube connector to the dome.
  - A. Assemble the tube connector with the dome and rotate the tube connector to lock it with the dome.

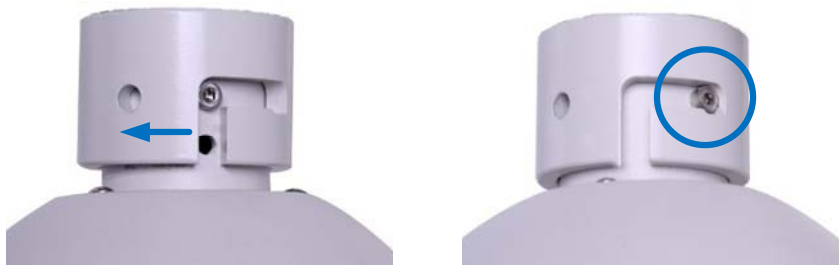

- B. Secure the tube connector with the supplied M6 screws.



5. Thread the camera cable through the wall pendant tube (GV-Mount203, No. 2), and assemble the dome housing and the tube with M6 screws.

6. Hinge and hook the pendant tube to the junction box.



7. Connect the network, power and other cables to the camera. See *1.6 Connecting the Camera, GV-IP Speed Dome GV-SD220 User's Manual* on the software CD.

## 6.8 Convex Corner Mount



---

This installation method is only applicable to **outdoor GV-IP Speed Dome (GV-SD220-S)**.

**Required accessories:**

- Pendant Tube (in GV-SD220-S standard package)
- GV-Mount310

**The user needs to prepare:**

- Screws for wall x 8

- 
1. Assemble the camera with the pendant tube. See *6.1 Assembling GV-SD220-S with Pendant Tube*.
  2. Follow steps 2, 4 and 5 in *5.8 Concave Corner Mount* to assemble the mounting plates and secure the camera to the wall.
  3. Connect the network, power and other cables to the camera. See *1.6 Connecting the Camera, GV-IP Speed Dome GV-SD220 User's Manual* on the software CD.

## 6.9 Pole Mount



---

This installation method is only applicable to **outdoor GV-IP Speed Dome (GV-SD220-S)**.

**Required accessories:**

- Pendant Tube (in GV-SD220-S standard package)
- GV-Mount400 or GV-Mount410

- 
1. Assemble the camera with the pendant tube. See *6.1 Assembling GV-SD220-S with Pendant Tube*.
  2. Follow step 2 in *5.9 Pole Mount* to secure the pole mount bracket.
  3. Follow step 4 in *5.9 Pole Mount* to secure the camera to the pole.
  4. Connect the network, power and other cables to the camera. See *1.6 Connecting the Camera, GV-IP Speed Dome GV-SD220 User's Manual* on the software CD.



## 6.10 Pole Box Mount



This installation method is only applicable to **outdoor GV-IP Speed Dome (GV-SD220-S)**.

### Required accessories:

- GV-Mount203
- GV-Mount400 or GV-Mount410
- GV-Mount903

### Required accessories:

- Corrugated tube x 1 (3/4",  $\varnothing$  26.0 ~ 26.5 mm)



1. Follow step 1 in *6.1 Assembling GV-SD220-S with Pendant Tube* to insert the desiccant.
2. Follow steps 2 to 4 in *5.10 Pole Box Mount* to install the junction box, mounting bracket and corrugated tube.

3. Remove the tube connector from the pendant tube with the supplied hex key. Save the M6 screws for later use.

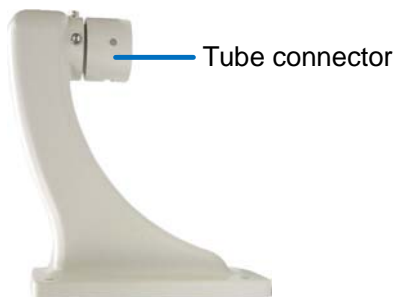

4. Secure the tube connector to the dome.
  - A. Assemble the tube connector with the dome and rotate the tube connector to lock it with the dome.

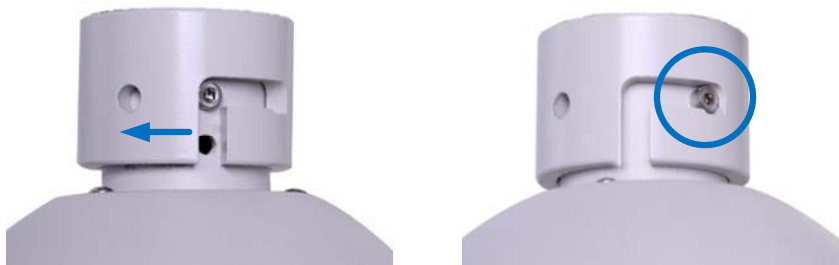

- B. Secure the tube connector with the supplied M6 screws.



5. Thread the camera cable through the pendant tube (GV-Mount203, No. 2) and secure them together with M6 screws.
6. Follow step 6 in *5.10 Pole Box Mount* to hook the pendant tube to the junction box.
7. Connect the network, power and other cables to the camera. See *1.6 Connecting the Camera, GV-IP Speed Dome GV-SD220 User's Manual* on the software CD.
8. Conceal the junction box with M5 screws (GV-Mount203, No. 3) using the torx wrench (GV-Mount203, No. 5).

# Note for Closing the Bullet Camera Cover

To ensure that the camera performs its full capacity against water and dust, adhere to the following guidelines when closing the Bullet Camera cover:

## 1. Line up the dots

Tighten the camera cover until the dots on the cover and the body line up as indicated below.



## 2. Make your own marks

For earlier models, you may not have dots on your camera. In this case, make your own marks on the camera cover and the body to note down the position.

# 7. Installing the Bullet Camera

## 7.1 Convex Corner Mount

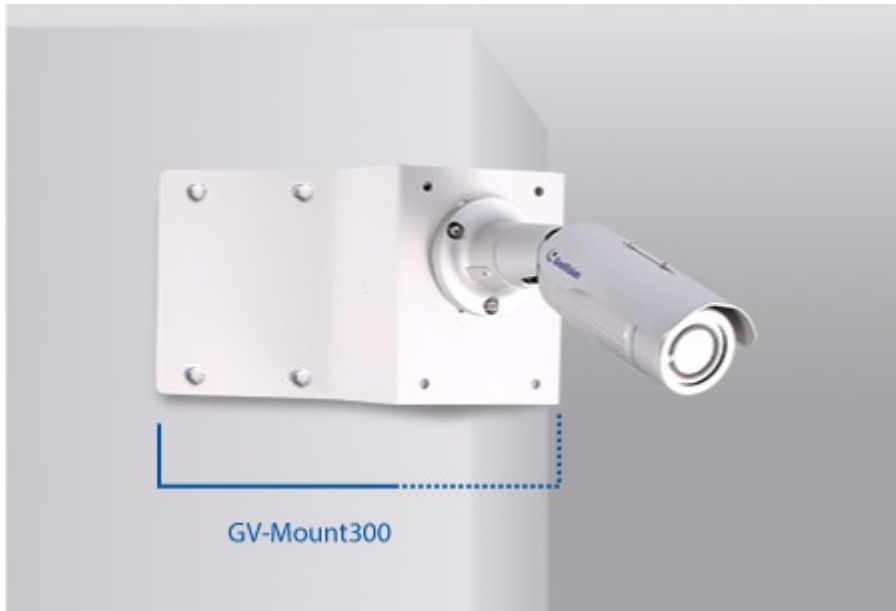

---

**Required accessories:**

- GV-Mount300

**The user needs to prepare:**

- Screws for wall x 8
- 

1. Assemble the mounting plates (GV-Mount300, No. 1), slide in the plain washer (GV-Mount300, No. 4), then the split washer (GV-Mount300, No. 5), and secure with the screw cap (GV-Mount300, No. 6).

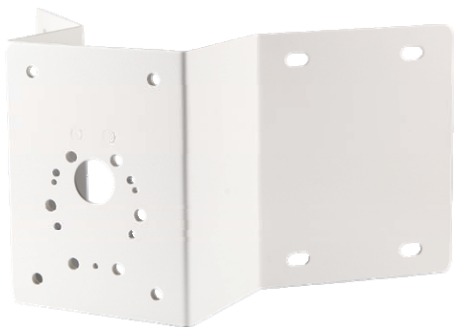

2. Assemble the camera with the mounting plates.
  - A. Thread the camera cable through the wall mount brackets.
  - B. Slide the M5 screws (GV-Mount300, No. 7) from front and secure from the backside using M5 plain washer (GV-Mount300, No. 8), M5 split washer (GV-Mount300, No. 9) and M5 screw cap (GV-Mount300, No. 10).



3. Secure the plates to the wall with 8 self-prepared screws.
4. Refer to the indicated sections of the **GV-IPCam H.264 User's Manual on the software CD** to:
  - A. Connect the network, power and other cables to the camera. See *Connecting the Camera, Bullet Camera* Chapter.
  - B. Access the live view. See *Accessing the Live View, Getting Started* Chapter.
  - C. Adjust the angle, focus and zoom of the camera. See *Adjusting the Angles* and *Adjusting the Lens and Inserting a Memory Card* in *Bullet Camera* Chapter.
  - D. Install the sun-shield cover. See *Installing the Sun-Shield Cover, Bullet Camera* Chapter.

## 7.2 Concave Corner Mount



---

**Required accessories:**

- GV-Mount310

**The user needs to prepare:**

- Screws for wall x 8
- 

1. Assemble the mounting plates (GV-Mount310, No. 1), slide in the plain washer (GV-Mount310, No. 3), then the split washer (GV-Mount310, No. 4), and secure them with the screw cap (GV-Mount310, No. 5).

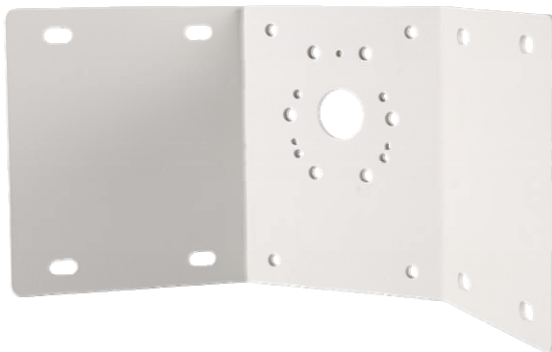

2. Assemble the camera with the mounting plates.
  - A. Thread the camera cable through the wall mount brackets.
  - B. Slide the M5 screws (GV-Mount310, No. 6) from front and secure from the backside using M5 plain washer (GV-Mount310, No. 7), M5 split washer (GV-Mount310, No. 8) and M5 screw cap (GV-Mount310, No. 9).

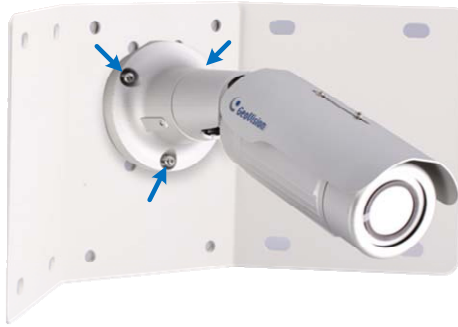

**Front View**



**Back View**

3. Secure the plates to the wall with 8 self-prepared screws.
4. Refer to the indicated sections of the **GV-IPCam H.264 User's Manual on the software CD** to:
  - A. Connect the network, power and other cables to the camera. See *Connecting the Camera, Bullet Camera* Chapter.
  - B. Access the live view. See *Accessing the Live View, Getting Started* Chapter.
  - C. Adjust the angle, focus and zoom of the camera. See *Adjusting the Angles and Adjusting the Lens and Inserting a Memory Card* in *Bullet Camera* Chapter.
  - D. Install the sun-shield cover. See *Installing the Sun-Shield Cover, Bullet Camera* Chapter.

## 7.3 Pole Mount



---

### Required accessories:

- GV-Mount400 or GV-Mount410
- 

1. Assemble the camera with the mounting bracket (GV-Mount400 / GV-Mount410, No.1).
  - A. Thread the camera cable through the mounting brackets.
  - B. Slide the M5 screws (GV-Mount400 / GV-Mount410, No.8) from front and secure from the backside using M5 plain washer (GV-Mount400 / GV-Mount410, No.9), M5 split washer (GV-Mount400 / GV-Mount410, No.10) and M5 screw cap (GV-Mount400 / GV-Mount410, No.11).



**Backside View**



## 7 Installing the Bullet Camera

2. Secure the mounting bracket to the pole using 3 steel straps (GV-Mount400 / GV-Mount410, No. 2). Rotate the screw on the strap to adjust its size.



3. Refer to the indicated sections of the **GV-IPCam H.264 User's Manual on the software CD** to:
  - A. Connect the network, power and other cables to the camera. See *Connecting the Camera, Getting Started* Chapter.
  - B. Access the live view. See *Accessing the Live View, Getting Started* Chapter.
  - C. Adjust the angle, focus and zoom of the camera. See *Adjusting the Angles and Adjusting the Lens and Inserting a Memory Card* in *Getting Started* Chapter.
  - D. Install the sun-shield cover. See *Installing the Sun-Shield Cover, Getting Started* Chapter.

# Note for Installing the Box Camera

The GV-Housing101 support indoor or outdoor installation of GV-BX Series. The supported GV-BX models are as below:

- GV-BX120D
- GV-BX130D-0 / BX130D-1
- GV-BX140DW
- GV-BX220D-2 / BX220D-3
- GV-BX320D-0 / BX320D-1
- GV-BX520D
- GV-BX1200 Series
- GV-BX1300 Series
- GV-BX1500 Series (except GV-BX1500-8F)
- GV-BX2400 Series
- GV-BX3400 Series (except GV-BX3400-8F)
- GV-BX5300 Series

For the following GV-BX Series with GV-Housing101, the shorter the focal length of camera lens you adjust, the more possibly the camera captures the housing box cover.

- GV-BX120D (2.8 ~ 12 mm)
- GV-BX140DW (2.8 ~ 12 mm)
- GV-BX220D-2 (2.8 ~ 6 mm)
- GV-BX320D-0 / BX320D-1 (3.1 ~ 8 mm / 2.8 ~ 6 mm)
- GV-BX1200-3V (2.8 ~ 12 mm)
- GV-BX1500-3V (2.8 ~ 12 mm)

For proper live view, you can adjust the position of camera and the focal length of camera lens as illustrated below.



# 8. Installing the Box Camera

## 8.1 Assembling Box Camera with the Housing Box



---

**Required accessories:**

- GV-Housing101 (with heater and fan)

**The user needs to prepare:**

- Ethernet, power, audio and I/O cables, etc for the camera
  - Silicon rubber to seal the camera
  - Mini USB cable with the connector of dimensions 9.6 x 7.6 mm or below for the camera (Optional)
  - Power wires for power board on the GV-Housing101 (24V AC / 12V DC input)
- 

1. Unscrew the housing box (GV-Housing101, No. 1) with torx wrench (GV-Housing101, No. 7).



2. Open the housing box, loosen the four screws and remove the black plate.



3. Remove the two black caps and the stoppers from the bottom of housing box.



4. Thread all the required cables through the supporting tube (GV-Housing101, No. 2) and then the two black caps as below. To ensure later installation, allocate the cables to the two black caps properly.



---

**Note:**

1. You need to use an Ethernet cable without RJ-45 connector to go through the housing box.
  2. For the mini USB cable (if required), you need to use the type with connector of dimensions 9.6 x 7.6 mm or below to go through the housing box.
-

## 8 Installing the Box Camera

5. Thread the cables through the holes at the bottom of the housing box and install the RJ-45 connector on the Ethernet cable.

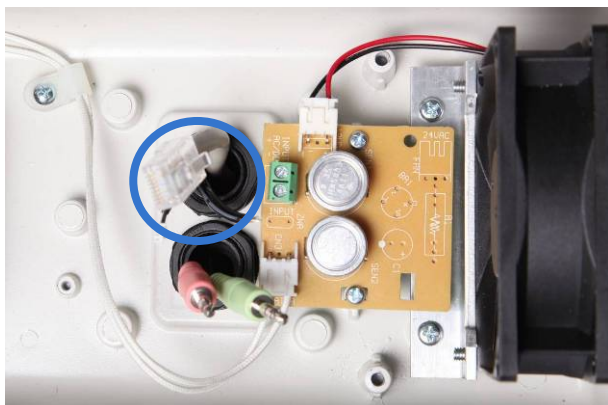

6. Assemble the short screw (GV-Housing101, No. 5) with M5 plain washer (GV-Housing101, No. 7) and secure the camera on the black plate.

Front View

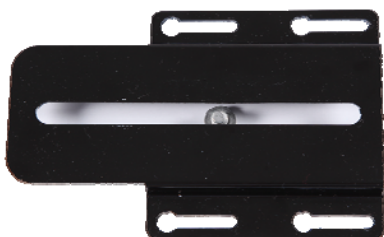

Back View with Camera



7. Line up the black plate with the four screws, slide it forward to adjust the camera's position as desired and tighten the screws.



8. Connect all the required cables to the camera and the power board.

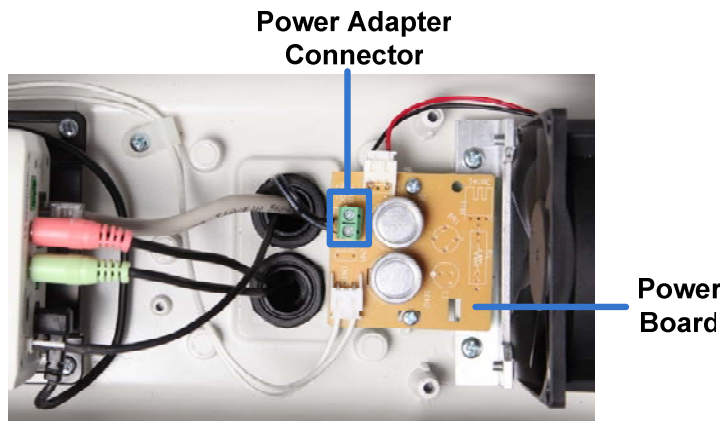

---

**Note:** Make sure the Power Adapter wires are connected to the correspondent electrodes labeled on the power board. Note this is only for the Power Adapter from GeoVision. If you are using different power adapter, the wires may have different colors.

- Black wire: negative electrode
  - Black with white stripes wire: positive electrode
- 

9. Tighten the black cap on the bottom of housing box. To waterproof the housing box, apply silicon rubber to fill the gap between the cables and the black caps.

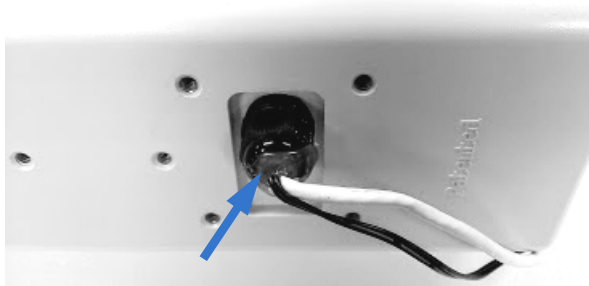

10. Secure the supporting tube on the bottom of housing box.

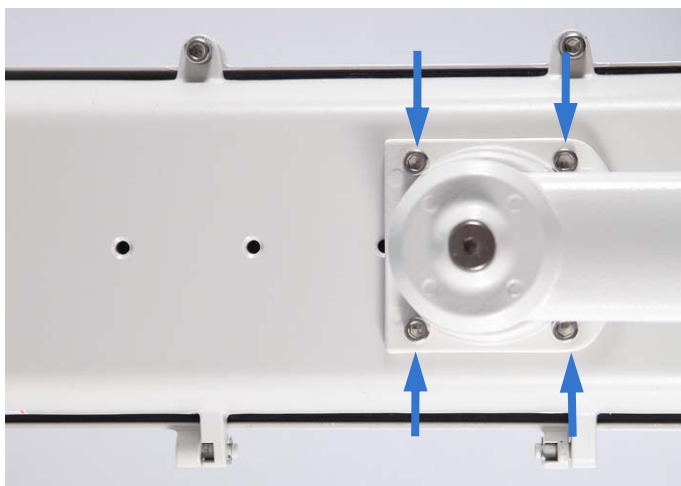

11. Mark the installation site, drill four holes and secure the housing box to the wall using the supplied screw anchors (GV-Housing101, No. 3), M5 screws (GV-Housing101, No. 4) and four plain washers (GV-Housing101, No. 6).



12. Adjust the camera to ensure proper live view:
- A. Access the live view of the camera. For the models supporting varifocal lens, check if the housing box cover is on the scene when adjusting the camera. For details, see *Note for Installing the Box Camera* earlier in this chapter.
  - B. Based on the live view, adjust the camera's position and the focal length of camera lens.
  - C. Use the torx wrench to adjust the joint angle of the housing box if necessary.
13. After the silicon rubber is dry, apply the supplied sticker in the housing box cover to paste the silica gel bag (GV-Housing101, No. 8) as below.



14. Secure the housing box cover with torx wrench.

---

**Note:** Make sure you conceal the silica gel bag in the housing box within two minutes of exposing to the open air.

---

## 8.2 Convex Corner Mount



---

### Required accessories:

- GV-Mount300

### The user needs to prepare:

- Screws for wall x 8
- 

1. Assemble the mounting plates (GV-Mount300, No. 1), slide in the plain washer (GV-Mount300, No. 4), then the split washer (GV-Mount300, No. 5), and secure with the screw cap (GV-Mount300, No. 6).

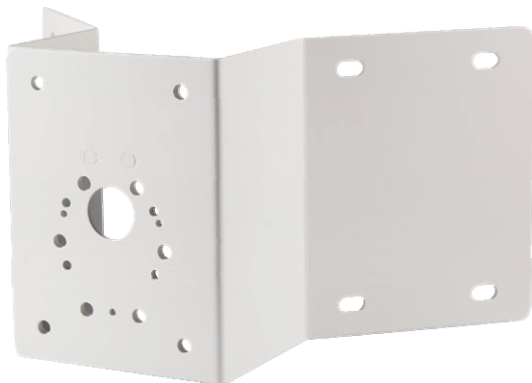



## 8 Installing the Box Camera

2. Assemble the housing box with the mounting plates:
  - A. Thread the camera cables through the mounting plates.
  - B. Slide the 20 mm M5 screws (GV-Mount300, No. 4) from front and secure from the backside using plain washer (GV-Mount300, No. 4), split washer (GV-Mount300, No. 5) and screw cap (GV-Mount300, No. 6).



3. Secure the plates to the wall with 8 self-prepared screws.

## 8.3 Concave Corner Mount



---

**Required accessories:**

- GV-Mount310

**The user needs to prepare:**

- Screws for wall x 8
- 

1. Assemble the mounting plates (GV-Mount310, No. 1), slide in the plain washer (GV-Mount310, No. 3), then the split washer (GV-Mount310, No. 4), and secure them with the screw cap (GV-Mount310, No. 5).

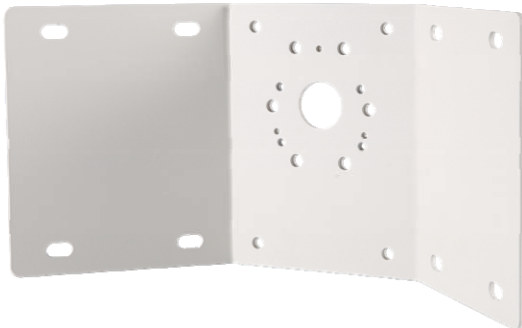

## 8 Installing the Box Camera

2. Assemble the camera with the mounting plates.
  - A. Thread the camera cable through the mounting plates.
  - B. Slide the 20 mm M5 screws (GV-Mount310, No. 2) from front and secure from the backside using plain washer (GV-Mount310, No. 3), split washer (GV-Mount310, No. 4) and screw cap (GV-Mount300, No. 5).

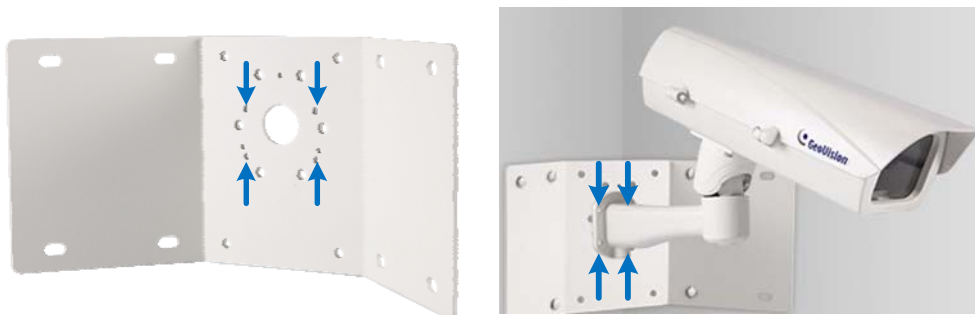

3. Secure the plates to the wall with 8 self-prepared screws.

## 8.4 Pole Mount



---

### Required accessories:

- GV-Mount400 or GV-Mount410
- 

1. Assemble the camera with the mounting bracket (GV-Mount400 / GV-Mount410, No.1).
  - A. Thread the camera cables through the mounting bracket.
  - B. Slide the 20 mm M5 screws (GV-Mount400 / GV-Mount410, No. 3) from the front and secure from the backside using plain washer (GV-Mount400 / GV-Mount410, No. 9), split washer, (GV-Mount400 / GV-Mount410, No. 10) and M5 screw cap (GV-Mount400 / GV-Mount410, No. 11).



## 8 Installing the Box Camera

2. Secure the mounting bracket to the pole using 3 steel straps (GV-Mount400 / GV-Mount410, No. 2). Rotate the screw on the strap to adjust its size.



# 9. Installing the Arctic Box Camera

## 9.1 Convex Corner Mount



---

**Required accessories:**

- GV-Mount300

**The user needs to prepare:**

- Screws for wall x 8
- 

1. Assemble the mounting plates (GV-Mount300, No. 1), slide in the plain washer (GV-Mount300, No. 4), then the split washer (GV-Mount300, No. 5), and secure with the screw cap (GV-Mount300, No. 6).

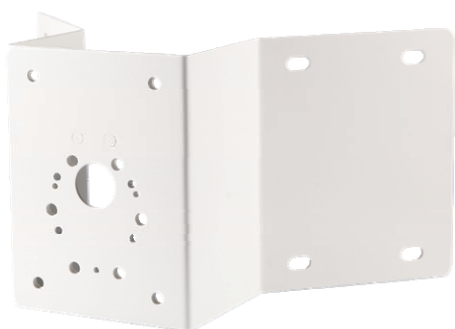

2. Assemble the camera with the mounting plates.
  - A. Thread the camera cable through the mounting plates.
  - B. Slide the 30 mm M8 screws (GV-Mount300, No. 2) from front and secure from the backside using plain washer (GV-Mount300, No. 4), split washer (GV-Mount300, No. 5) and screw cap (GV-Mount300, No. 6).



3. Secure the plates to the wall with 8 self-prepared screws.
4. Refer to the indicated sections of the **GV-IPCam H.264 User's Manual on the software CD** to:
  - A. Connect the camera to PoE. See *Connecting the Camera, IR Arctic Box Camera Chapter*.
  - B. Access the live view. See *Accessing the Live View, Getting Started Chapter*.
  - C. Adjust the angle, focus and zoom of the camera. See steps 6 and 7 in *Installation, IR Arctic Box Camera Chapter*.
  - D. Replace the silica gel bag and secure the housing cover. See steps 8 and 9 in *Installation, IR Arctic Box Camera Chapter*.

## 9.2 Concave Corner Mount



---

**Required accessories:**

- GV-Mount310

**The user needs to prepare:**

- Screws for wall x 8
- 

1. Assemble the mounting plates (GV-Mount310, No. 1), slide in the plain washer (GV-Mount310, No. 3), then the split washer (GV-Mount310, No. 4), and secure them with the screw cap (GV-Mount310, No. 5).

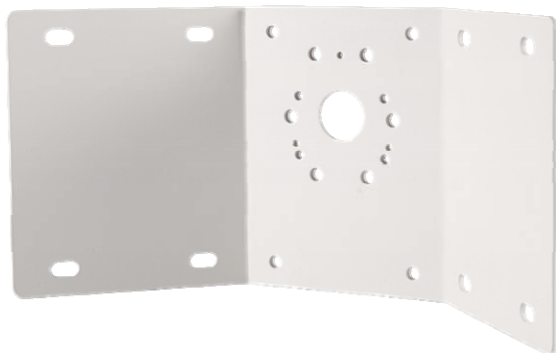



2. Assemble the camera with the mounting plates.
  - A. Thread the camera cable through the mounting plates.
  - B. Slide the 30 mm M8 screws (GV-Mount310, No. 2) from front and secure from the backside using plain washer (GV-Mount310, No. 3), split washer (GV-Mount310, No. 4) and screw cap (GV-Mount300, No. 5).



3. Secure the plates to the wall with 8 self-prepared screws.
4. Refer to the indicated sections of the **GV-IPCam H.264 User's Manual on the software CD** to:
  - A. Connect the camera to PoE. See *Connecting the Camera, IR Arctic Box Camera* Chapter..
  - B. Access the live view. See *Accessing the Live View, Getting Started* Chapter.
  - C. Adjust the angle, focus and zoom of the camera. See steps 6 and 7 in *Installation, IR Arctic Box Camera* Chapter.
  - D. Replace the silica gel bag and secure the housing cover. See steps 8 and 9 in *Installation, IR Arctic Box Camera* Chapter.

## 9.3 Pole Mount



---

### Required accessories:

- GV-Mount400 or GV-Mount410
- 

1. Assemble the camera with the mounting bracket (GV-Mount400 / GV-Mount410, No.1).
  - A. Thread the camera cable through the mounting bracket.
  - B. Slide the 30 mm M8 screws (GV-Mount400 / GV-Mount410, No. 3) from the front and secure from the backside using plain washer (GV-Mount400 / GV-Mount410, No. 5), split washer, (GV-Mount400 / GV-Mount410, No. 6) and M8 screw cap (GV-Mount400 / GV-Mount410, No. 7).



**Backside View**

2. Secure the mounting bracket to the pole using 3 steel straps (GV-Mount400 / GV-Mount410, No. 2). Rotate the screw on the strap to adjust its size.



3. Refer to the indicated sections of the **GV-IPCam H.264 User's Manual on the software CD** to:
  - A. Connect the camera to PoE. See *Connecting the Camera, IR Arctic Box Camera Chapter*.
  - B. Access the live view. See *Accessing the Live View, Getting Started Chapter*.
  - C. Adjust the angle, focus and zoom of the camera. See steps 6 and 7 in *Installation, IR Arctic Box Camera Chapter*.
  - D. Replace the silica gel bag and secure the housing cover. See steps 8 and 9 in *Installation, IR Arctic Box Camera Chapter*.

# 10. Installing the Mini Fixed Dome

## 10.1 L-Shaped Wall Mount



---

### Required accessories:

- GV-Mount900
- 

1. Take the wall mount bracket (GV-Mount900, No. 1) and make 2 marks on the wall for screw anchors.

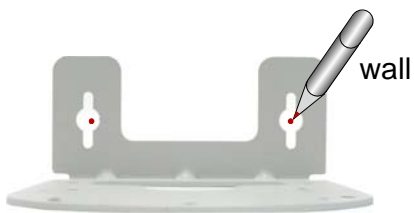

2. Drill the marks and insert 2 screw anchors (GV-Mount900, No. 2).
3. Insert the wall mount screws (GV-Mount900, No. 3) and leave enough distance (approximately 2 mm) to hang the wall mount bracket later.

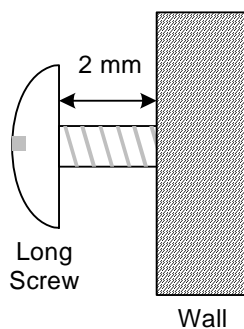

4. Hang the wall mount bracket on the wall mount screws and push the wall mount bracket downward. Tighten the wall mount screws to the wall.

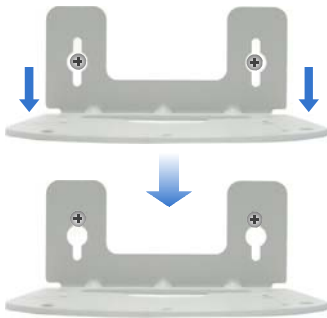

5. Unscrew the camera's cover using the supplied torx wrench.
6. Align and secure the camera to the wall mount bracket with two M3 screws (GV-Mount900, No. 4).

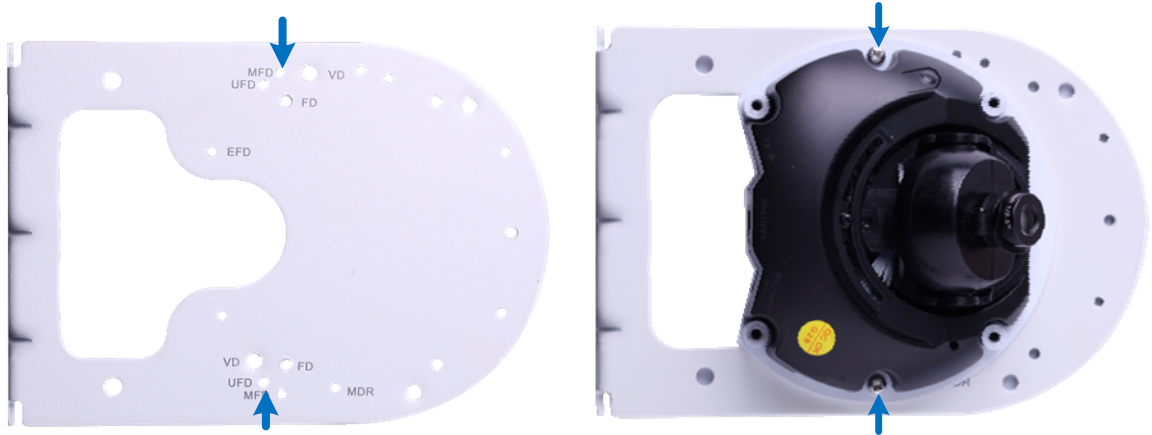

7. Refer to the indicated sections of the **GV-IPCam H.264 User's Manual on the software CD** to:
  - A. Connect the network, power and other cables to the camera. See *Connecting the Camera, Mini Fixed Dome & Mini Fixed Rugged Dome* Chapter.
  - B. Access the live view. See *Accessing the Live View, Getting Started* Chapter.
  - C. Based on the live view, adjust the pan and tilt angles and secure the housing cover with the torx wrench. See steps 7 in *GV-MFD Series, Mini Fixed Dome & Mini Fixed Rugged Dome* Chapter.

## 10.2 Wall Box Mount



---

### Required accessories:

- GV-Mount909
- 

1. Take the wall mount bracket (GV-Mount909, No. 1) and make 4 marks on the wall for screw anchors.

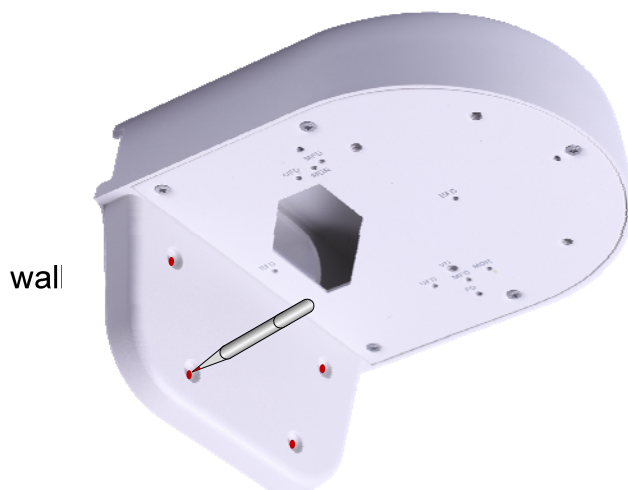

2. Drill the marks and insert 4 screw anchors (GV-Mount909, No. 2).
3. Secure the wall mount bracket to the wall with wall mount screws (GV-Mount909, No. 3).
4. Unscrew the camera's cover using the supplied torx wrench.

5. Align and secure the camera to the wall mount bracket with two M3 screws (GV-Mount909, No. 4).



6. Refer to the indicated sections of the **GV-IPCam H.264 User's Manual on the software CD** to:
  - A. Thread the network, power and other cables through the wall mount bracket and connect them to the camera. See *Connecting the Camera, Mini Fixed Dome & Mini Fixed Rugged Dome* Chapter.
  - B. Access the live view. See *Accessing the Live View, Getting Started* Chapter.
  - C. Based on the live view, adjust the pan and tilt angles and secure the housing cover with the torx wrench. See steps 7 in *GV-MFD Series, Mini Fixed Dome & Mini Fixed Rugged Dome* Chapter.

## 10.3 Power Box Mount



---

### Required accessories:

- GV-Mount910 or GV-Mount913

### The user needs to prepare

- Screws for securing the mounting plate to power box
- 

1. Secure the mounting plate (GV-Mount910 or GV-Mount913, No. 1) to the power box with your own screws. Depending on the type of power box, use the holes indicated with the corresponding letter:

### GV-Mount910

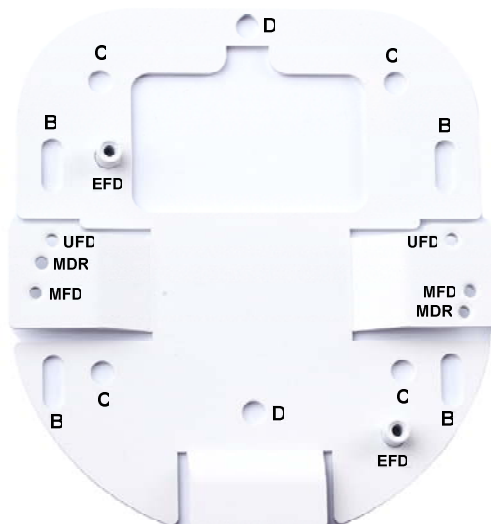

Type of Power Box	Hole
Double Gang	B
4" Octagon	C
Single Gang	D



## GV-Mount913

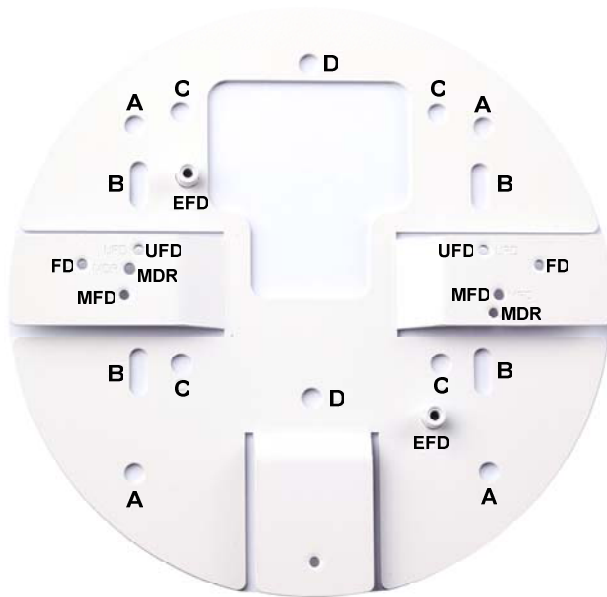

Type of Power Box	Hole
4" Square	A
Double Gang	B
4" Octagon	C
Single Gang	D

2. Remove camera cover with the supplied torx wrench.
3. Secure the camera to the mounting plate with M3 screws (GV-Mount910 or GV-Mount913, No. 2). Use the holes indicated with MFD.



4. Refer to the indicated sections of the **GV-IPCam H.264 User's Manual on the software CD** to:
  - A. Connect the network, power and other cables to the camera. See *Connecting the Camera, Mini Fixed Dome & Mini Fixed Rugged Dome* Chapter.
  - B. Access the live view. See *Accessing the Live View, Getting Started* Chapter.
  - C. Based on the live view, adjust the pan and tilt angles and secure the housing cover with the torx wrench. See steps 7 in *GV-MFD Series, Mini Fixed Dome & Mini Fixed Rugged Dome* Chapter.

# 11. Installing the Mini Fixed Rugged Dome

## 11.1 L-Shaped Wall Mount



---

**Required accessories:**

- GV-Mount900
- 

1. Take the wall mount bracket (GV-Mount900, No. 1) and make 2 marks on the wall for screw anchors.

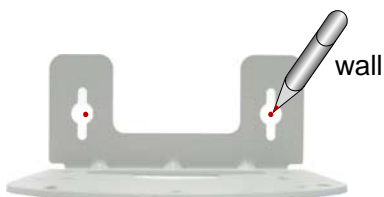

2. Drill the marks and insert 2 screw anchors (GV-Mount900, No. 2).

## 11 Installing the Mini Fixed Rugged Dome

3. Insert the wall mount screws (GV-Mount900, No. 3) and leave enough distance (approximately 2 mm) to hang the wall mount bracket later.

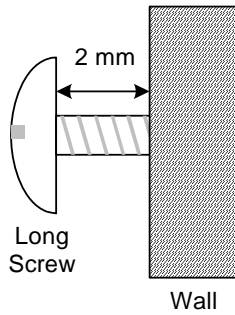

4. Hang the wall mount bracket on the wall mount screws and push the wall mount bracket downward. Tighten the wall mount screws to the wall.

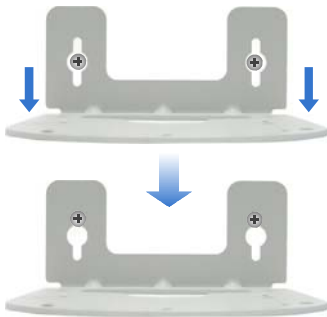

5. Unscrew the camera's cover using the supplied torx wrench.

6. Align and secure the camera to the wall mount bracket with two M3 screws (GV-Mount900, No. 4).

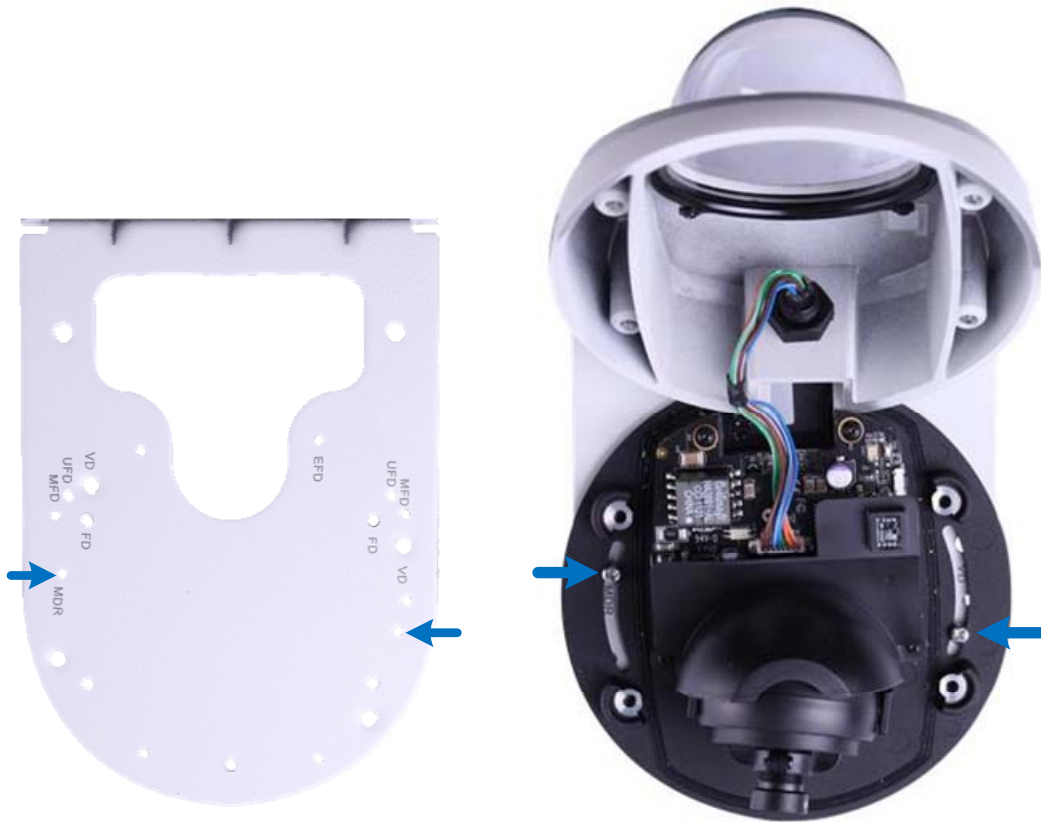

7. Refer to the indicated sections of the **GV-IPCam H.264 User's Manual on the software CD** to:
  - A. Waterproof the cable with the supplied cable connector. See step 6 in *GV-MDR Series, Mini Fixed Dome & Mini Fixed Rugged Dome* Chapter.
  - B. Connect the network and power to the camera.
  - C. Access the live view. See *Accessing the Live View, Getting Started* Chapter.
  - D. Based on the live view, adjust the angle of the camera. See steps 8 in *GV-MDR Series, Mini Fixed Dome & Mini Fixed Rugged Dome* Chapter.
  - E. Replace the silica gel bag and secure the camera's cover with the supplied torx wrench.

## 11.2 Wall Box Mount



---

### Required accessories:

- GV-Mount909
- 

**IMPORTANT:** The GV-Mount909 is not IP66 protected. Make sure you install the camera in a dry place.

---

1. Take the wall mount bracket (GV-Mount909, No. 1) and make 4 marks on the wall for screw anchors.

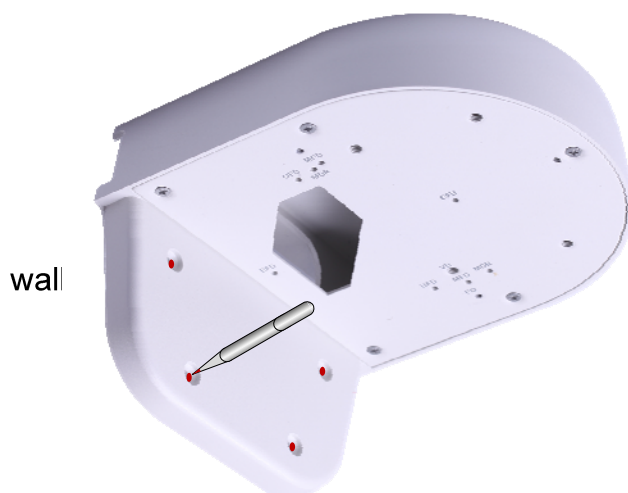

2. Drill the marks and insert 4 screw anchors (GV-Mount909, No. 2).
3. Secure the wall mount bracket to the wall with wall mount screws (GV-Mount909, No. 3).

4. Unscrew the camera's cover using the supplied torx wrench.
5. Thread the cable through the wall mount bracket and secure the camera to the wall mount bracket with two M3 screws (GV-Mount909, No. 4). Use the labels on the wall mount bracket to help you.

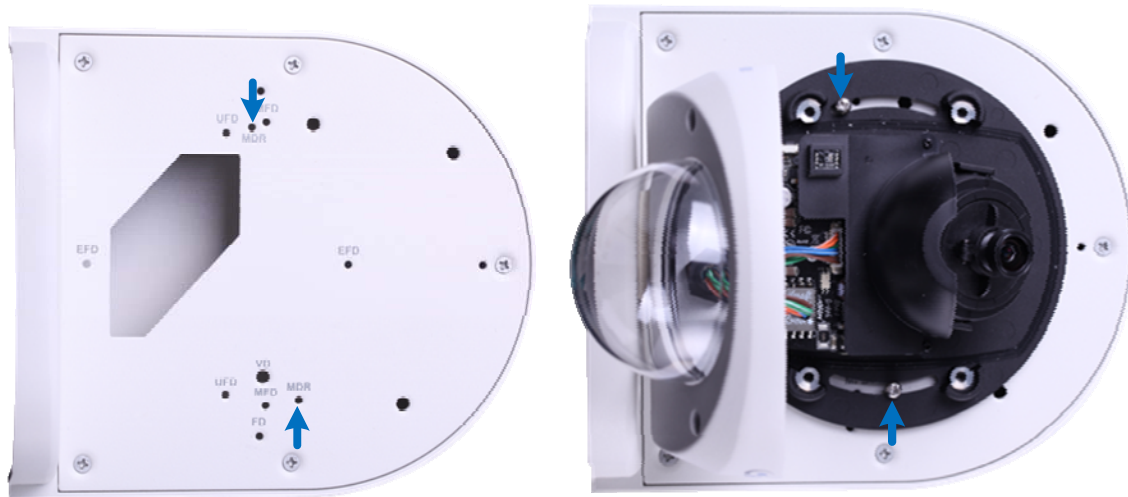

6. Refer to the indicated sections of the **GV-IPCam H.264 User's Manual on the software CD** to:
  - A. Waterproof the cable with the supplied cable connector. See step 6 in *GV-MDR Series, Mini Fixed Dome & Mini Fixed Rugged Dome* Chapter.
  - B. Connect the network and power to the camera.
  - C. Access the live view. See *Accessing the Live View, Getting Started* Chapter.
  - D. Based on the live view, adjust the angle of the camera. See steps 8 in *GV-MDR Series, Mini Fixed Dome & Mini Fixed Rugged Dome* Chapter.
  - E. Replace the silica gel bag and secure the camera's cover with the supplied torx wrench.

## 11.3 Power Box Mount



### Required accessories:

- GV-Mount910 or GV-Mount913

### The user needs to prepare

- Screws for securing the mounting plate to power box

1. Secure the mounting plate (GV-Mount910 or GV-Mount913, No. 1) to the power box with your own screws. Depending on the type of power box, use the holes indicated with the corresponding letter:

### GV-Mount910

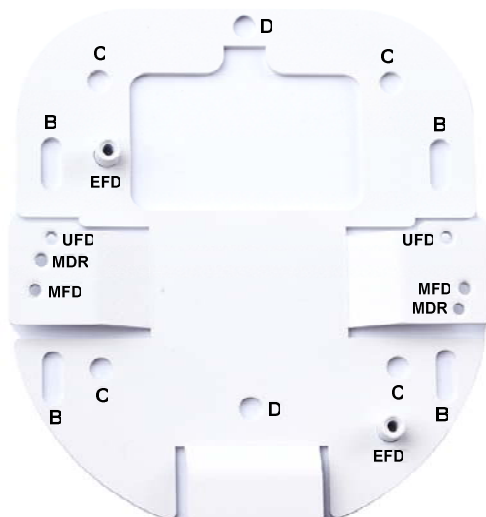

Type of Power Box	Hole
Double Gang	B
4" Octagon	C
Single Gang	D

### GV-Mount913

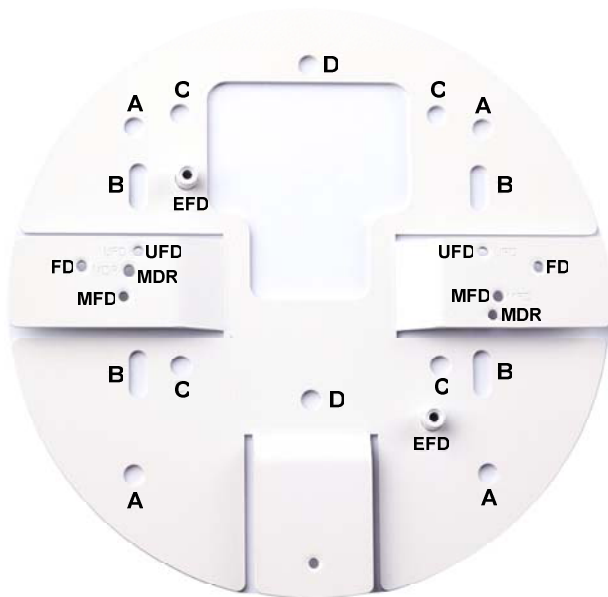

Type of Power Box	Hole
4" Square	A
Double Gang	B
4" Octagon	C
Single Gang	D

- Open the camera cover with the supplied torx wrench.
- Thread the camera cable through the mounting plate and the power box, and secure the camera to the mounting plate with M3 screws (GV-Mount910 or GV-Mount913, No. 2). Use the holes indicated with "MDR".



- Refer to the indicated sections of the **GV-IPCam H.264 User's Manual on the software CD** to:
  - Waterproof the cable with the supplied cable connector. See step 6 in *GV-MDR Series, Mini Fixed Dome & Mini Fixed Rugged Dome* Chapter.
  - Connect the network and power to the camera.
  - Access the live view. See *Accessing the Live View, Getting Started* Chapter.



## 11 Installing the Mini Fixed Rugged Dome

- D. Based on the live view, adjust the angle of the camera. See steps 8 in *GV-MDR Series, Mini Fixed Dome & Mini Fixed Rugged Dome* Chapter.
- E. Replace the silica gel bag and secure the camera's cover with the supplied torx wrench.

# 12. Installing the Target Mini Fixed Dome

## 12.1 L-Shaped Wall Mount



---

**Required accessories:**

- GV-Mount900
- 

1. Take the wall mount bracket (GV-Mount900, No. 1) and make 2 marks on the wall for screw anchors.

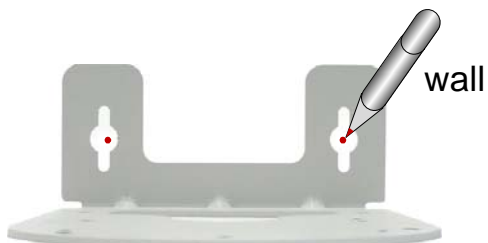

2. Drill the marks and insert 2 screw anchors (GV-Mount900, No. 2).

## 12 Installing the Target Mini Fixed Dome

3. Insert the wall mount screws (GV-Mount900, No. 3) and leave enough distance (approximately 2 mm) to hang the wall mount bracket later.

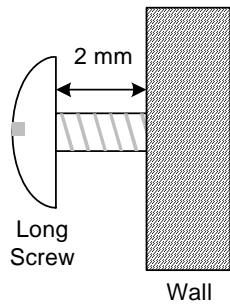

4. Hang the wall mount bracket on the wall mount screws and push the wall mount bracket downward. Tighten the wall mount screws to the wall.

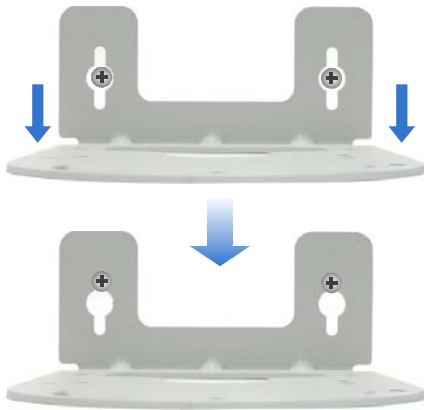

5. Open the camera housing cover by turning.
6. Align and secure the camera to the wall mount bracket with two M3 screws (No. 4, GV-Mount900).

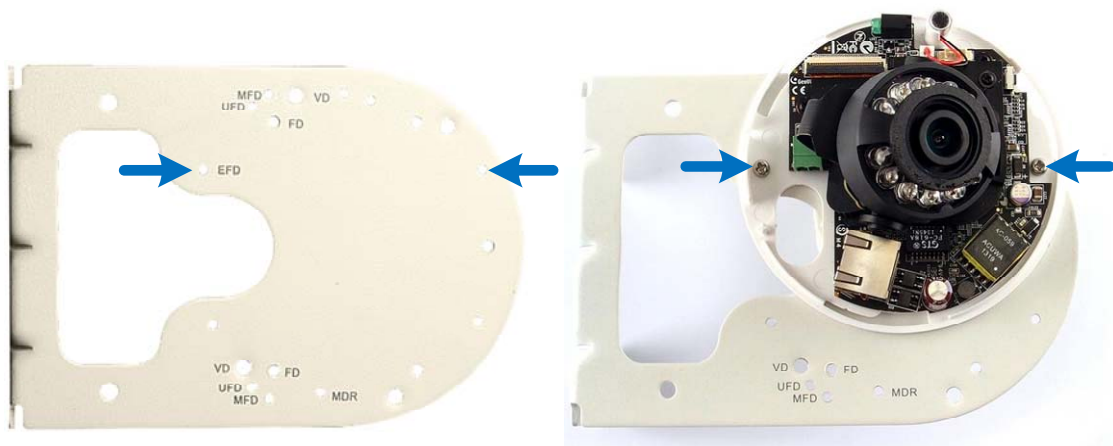

7. Refer to the indicated sections of the **GV-IPCam H.264 User's Manual on the software CD** to:
  - A. Connect the camera to power and network. See *Connecting the Camera, Target Mini Fixed Dome* Chapter.
  - B. Access the live view. See *Accessing the Live View, Getting Started* Chapter.
  - C. Based on the live view, adjust the pan and tilt angles and secure the housing cover. See steps 7 in *Installation, Target Mini Fixed Dome* Chapter.

## 12.2 Wall Box Mount



---

**Required accessories:**

- GV-Mount909
- 

1. Take the wall mount bracket (GV-Mount909, No. 1) and make 4 marks on the wall for screw anchors.



2. Drill the marks and insert 4 screw anchors (GV-Mount909, No. 2).
3. Secure the wall mount bracket to the wall with wall mount screws (GV-Mount909, No. 3).
4. Open the camera housing cover by turning.

5. Align and secure the camera to the wall mount bracket with two M3 screws (GV-Mount909, No. 4).



6. Refer to the indicated sections of the **GV-IPCam H.264 User's Manual on the software CD** to:
  - A. Thread the network and power cables through the wall mount bracket and connect them to the camera. See *Connecting the Camera, Target Mini Fixed Dome* Chapter.
  - B. Access the live view. See *Accessing the Live View, Getting Started* Chapter.
  - C. Based on the live view, adjust the pan and tilt angles and secure the housing cover. See steps 7 in *Installation, Target Mini Fixed Dome* Chapter.

## 12.3 Power Box Mount



**Required accessories:**

- GV-Mount910 or GV-Mount913

**The user needs to prepare**

- Screws for securing the mounting plate to power box

1. Secure the mounting plate (GV-Mount910 or GV-Mount913, No. 1) to the power box with your own screws. Depending on the type of power box, use the holes indicated with the corresponding letter:

**GV-Mount910**

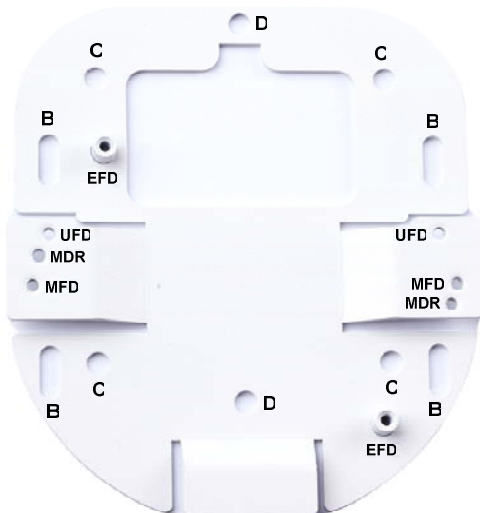

Type of Power Box	Hole
Double Gang	B
4" Octagon	C
Single Gang	D

### GV-Mount913

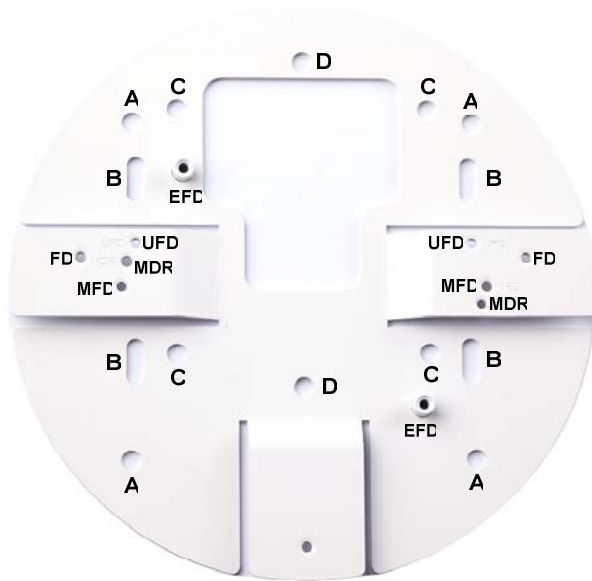

Type of Power Box	Hole
4" Square	A
Double Gang	B
4" Octagon	C
Single Gang	D

2. Open the camera housing cover by turning.
3. Secure the camera to the mounting plate with M3 screws (GV-Mount910 or GV-Mount913, No. 2). Use the holes labeled as EFD.

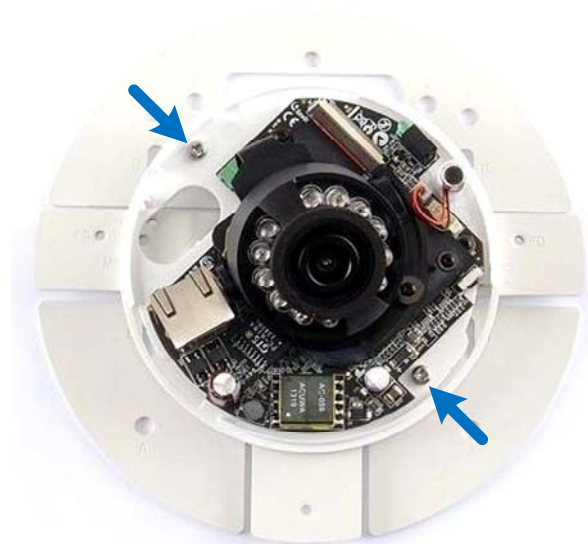

4. Refer to the indicated sections of the **GV-IPCam H.264 User's Manual on the software CD** to:
  - A. Connect the camera to network and power, and thread the cables through the cable opening on the side. See *Connecting the Camera, Target Mini Fixed Dome* Chapter.
  - B. Access the live view. See *Accessing the Live View, Getting Started* Chapter.
  - C. Based on the live view, adjust the pan and tilt angles and secure the housing cover. See steps 7 in *Installation, Target Mini Fixed Dome* Chapter.